

THE FAMILY FALLOUT SHELTER

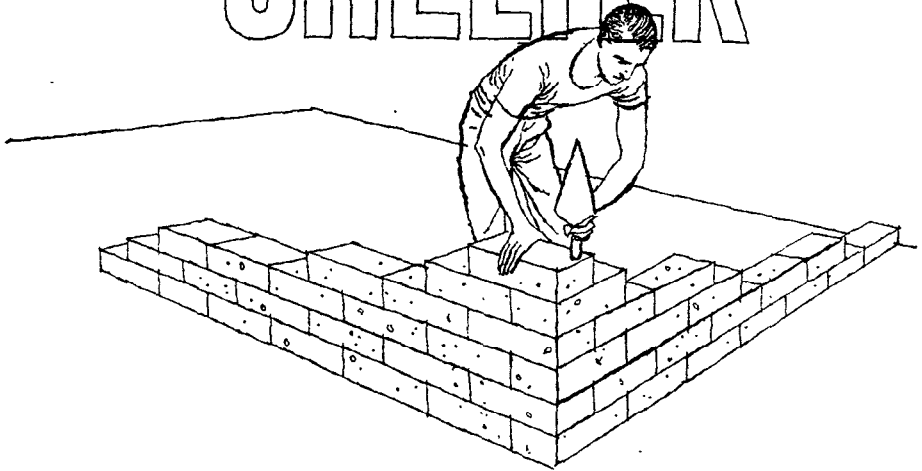

MP-15.

A committee of the National Academy of Sciences, in a recent study of national preparedness, concluded:

"Adequate shielding is the only effective means of preventing radiation casualties."

INTRODUCTION

Let us take a hard look at the facts.

In an atomic war, blast, heat, and initial radiation could kill millions close to ground zero of nuclear bursts.

Many *more* millions—everybody else—could be threatened by radioactive fallout. But most of these could be saved.

The purpose of this booklet is to show how to escape death from fallout.

Everyone, even those far from a likely target, would need shelter from fallout.

Your Federal Government has a shelter policy based on the knowledge that most of those beyond the range of blast and heat will survive if they have adequate protection from fallout.

This booklet contains building plans for five basic fallout shelters. One of the five—the Basement Concrete Block Shelter—has been designed specifically as a do-it-yourself project. Solid concrete blocks are used to build it. Most people probably would need the assistance of a contractor to build any of the other four types.

The least expensive shelter described is the Basement Concrete Block Shelter. The most expensive is the Underground Concrete Shelter.

Savings usually can be realized if a shelter is constructed at the time a house is being built.

Each of the shelters incorporates the fundamentals for fallout protection—shielding mass, ventilation, space to live. Each can serve a dual purpose—protection from tornadoes and other severe storms in addition to protection from the fallout radiation of a nuclear bomb.

There *are* means of protection.

But that protection must be provided before, not after, the sirens sound.

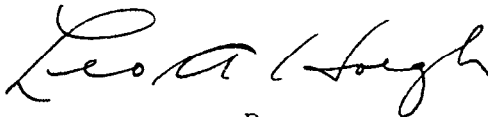

DIRECTOR
Office of Civil and Defense Mobilization

THE FAMILY FALLOUT SHELTER

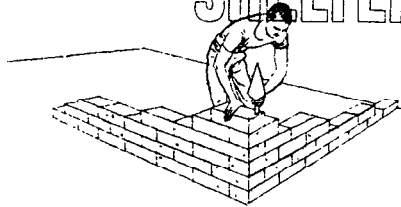

Contents

	<i>Page</i>
I. Fallout shelter is needed everywhere	4
II. The shelters	6
III. Living in a shelter	17
IV. If an attack finds you without a prepared shelter	18
V. Shelter in apartment buildings	19
VI. Why prepare a shelter now?	19
APPENDIX	20

JUNE 1959

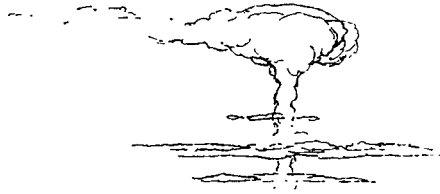

I. Fallout Shelter Is Needed Everywhere

One thing is certain if this country is attacked with nuclear weapons our air and missile bases will be primary targets.

The enemy would try to knock out our retaliatory power.

He might also try to destroy our cities.

No one can be sure now how far the enemy will go.

But it must be emphasized that even if an enemy confines his attack to our retaliatory bases, the radioactive fallout from his nuclear bombs would threaten life in the entire country. An atomic burst on the ground sends up a mushroom cloud from which radioactive dust will fall hundreds of miles away.

Fallout from one test explosion spread over 7,000 square miles of the Pacific Ocean.

The following maps show the spread of fallout after a large assumed attack on military and civilian targets. Hour by hour the fallout spreads and overlaps until, after 24 hours, it almost completely covers the Nation. (See figs. 1 and 2.)

Figure 1.—Fallout areas at 1 hour after detonation



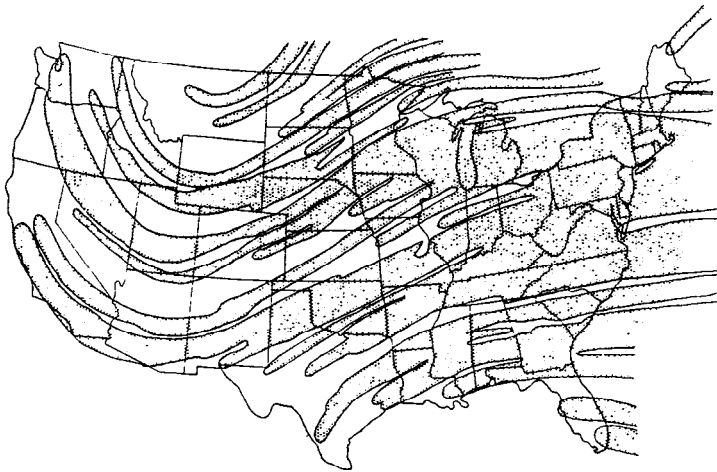
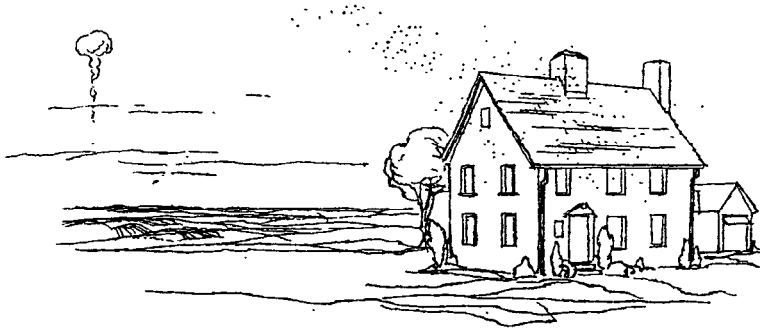

Figure 2.—Fallout areas at 24 hours after detonation

These maps show where the wind would have carried the fallout from the assumed attack on a given day. On another day, the wind could swing in any other direction and turn safe areas on these maps into areas of extreme fallout danger.

The fallout radiation threat indicated on the map is not uniform. The danger diminishes as the fallout drifts further from the points of nuclear explosion. But even on the extreme limits of the drift the fallout remains a menace to life and health for some time.

The lesson is: fallout shelter is needed everywhere.



II. The Shelters

YOU CAN PROTECT YOURSELF FROM FALLOUT RADIATION.

Any mass of material between you and the fallout will cut down the amount of radiation that reaches you. Sufficient mass will make you safe.

Concrete or bricks, earth or sand, are some of the materials heavy enough to afford protection by absorbing radiation. There is about the same amount of shielding in 8 inches of concrete, for instance, as in 12 inches of earth, 16 inches of books or 30 inches of wood. In most of the country, everywhere except in areas hit by the heaviest fallout, these thicknesses would give ample protection for a basement shelter.

The shelters suggested here have concrete and earth for shielding. You can build some of these shelters yourself. Others would require contractors. Some of the shelters are for basements, some for outdoors. For family shelters 10 square feet per person is adequate. (12½ square feet per person is recommended for mass shelters.)

BASEMENT CONCRETE BLOCK SHELTER

Basement shelters generally are the least expensive type that will give substantial protection. A basement shelter can be built with solid concrete blocks as a do-it-yourself project. The price of materials varies in different parts of the country. In May of 1959 sample bids showed a price range of between \$150 and \$200. This shelter would provide all the protection needed in most of the Nation. That means it would save many lives even in the areas of heaviest fallout, and most lives everywhere else.

This type of inexpensive basement shelter also can be incorporated in plans for new home construction. Other types of effective shelters can be built in new homes with relatively minor changes in design. (See Fig. 20.)

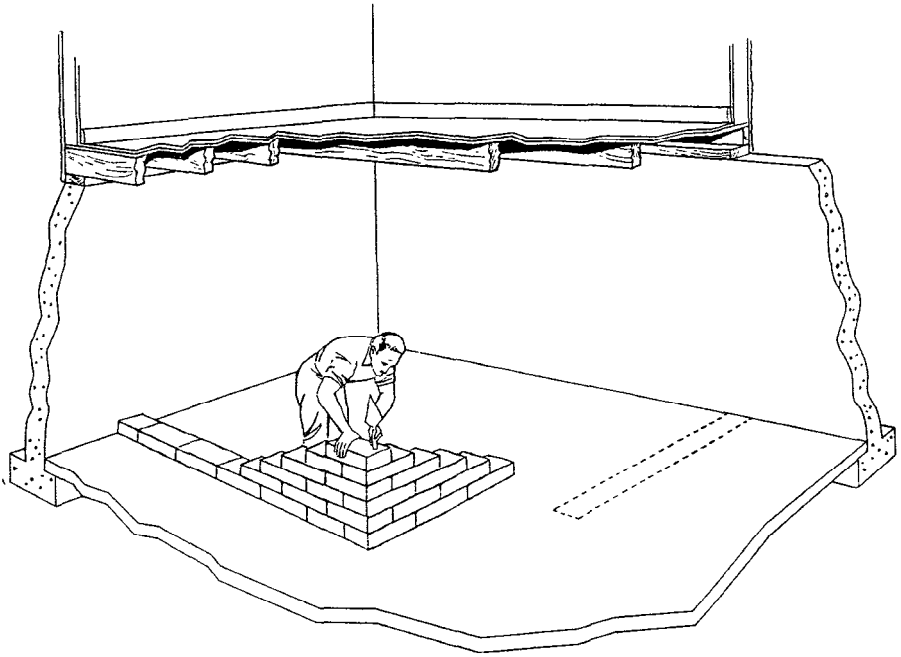

Figure 3

A row of solid concrete blocks is set in about three-eighths of an inch of wet mortar along guidelines marked on the basement floor. The corner is built about six blocks high (fig. 3). The remainder of the wall then is raised to the same height. The corner is built up once more and the wall again raised to its level. The wall is not raised all the way to the basement ceiling. Clear space of at least 16 inches is needed overhead to permit the later construction of the shelter roof. The top rows of concrete blocks are not set on the wall until after the roof is in place.

Ventilation is provided by an open doorway and vents near the floor in one wall. The four vents are simply small gaps in one layer of blocks.

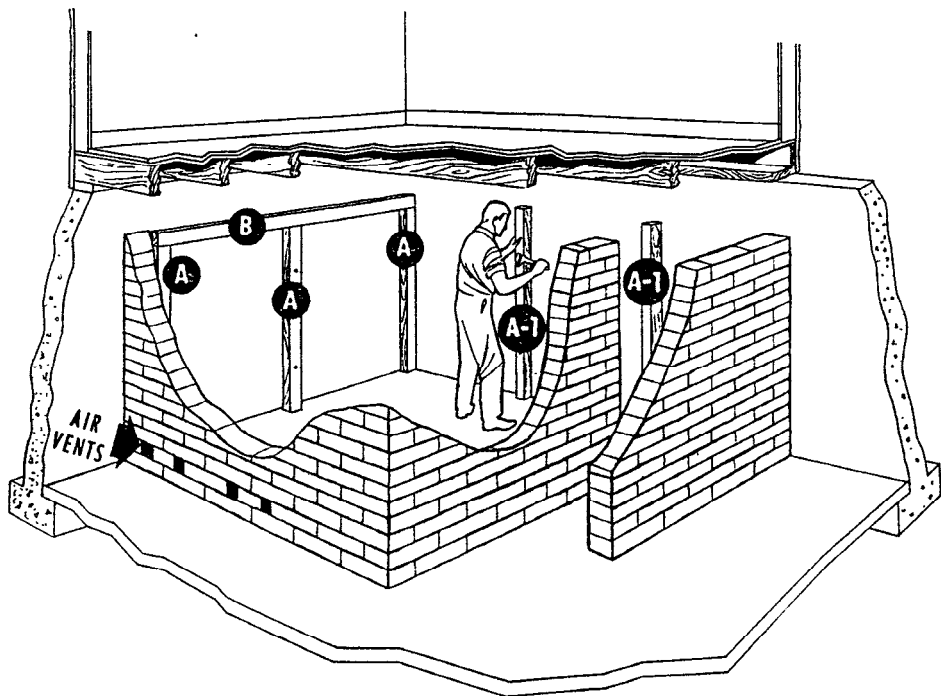

Figure 4

The wall protecting the shelter entrance from direct radiation should be the same height as the main shelter walls. The posts (marked "A" and "A-1" in fig. 4) that support the roof beams are fixed to the basement walls with $\frac{1}{2}$ -inch anchor bolts. The height of the posts marked "A-1" should equal the height of post "A" plus the thickness of beam "B." A wall beam (marked "B" in fig. 4) is put in place against the rear wall from one corner post to the other. The beam should be nailed to the uprights on which it rests.

The roof beams (marked "C" in fig. 5) are installed after the mortar in the block wall has dried at least a day. One end of each roof beam is nailed to the wall beam (marked "B" in fig. 5). The roof beams are placed on edge. Wood braces (marked "D" in fig. 5) hold them in place

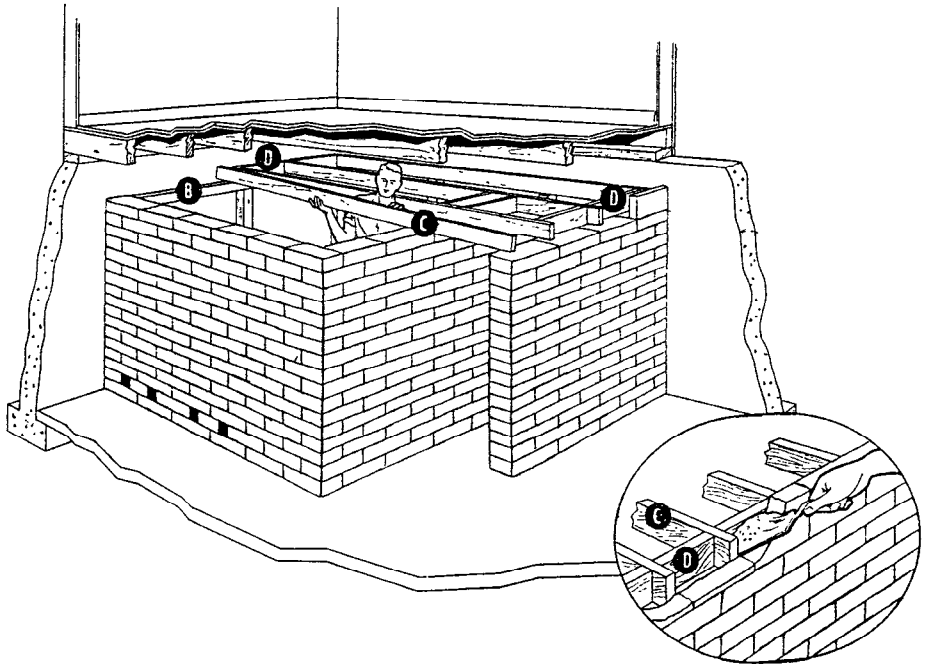

Figure 5

At the entrance side of the shelter, each roof beam is rested on the inside 4 inches of the block wall. The outside 4-inch space is filled by mortaring blocks on edge. The wooden bracing between the roof beams is placed flush with the inside of the wall. Mortar is poured between this bracing and the 4-inch blocks on edge to complete the wall thickness for radiation shielding. (For details see inset, fig. 5.)

The first one or two roof boards (marked "E" in fig. 6) are slipped into place across the roof beams, from outside the shelter. These boards are nailed to the roof beams by reaching up through the open space between the beams, from inside the shelter. Concrete blocks are passed between the beams and put on the boards. The roof blocks are in two layers and are not mortared together.

Work on the roof continues in this way. The last roof boards are covered with blocks from outside the shelter.

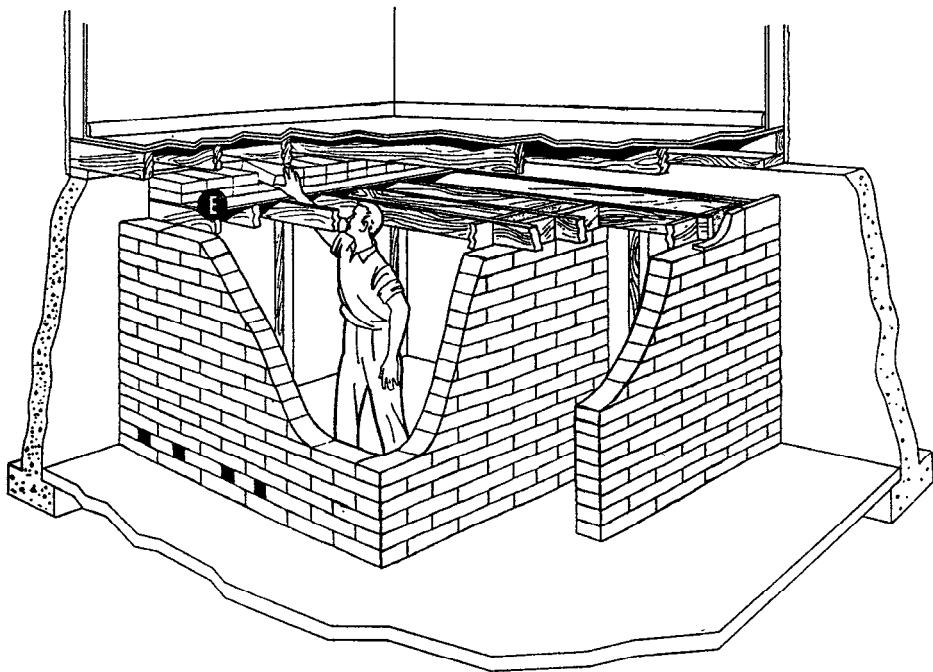

Figure 6

When the roof blocks are all in place, the final rows of wall blocks are mortared into position. The structure is complete. (See fig. 7.) Building plans are on page 21

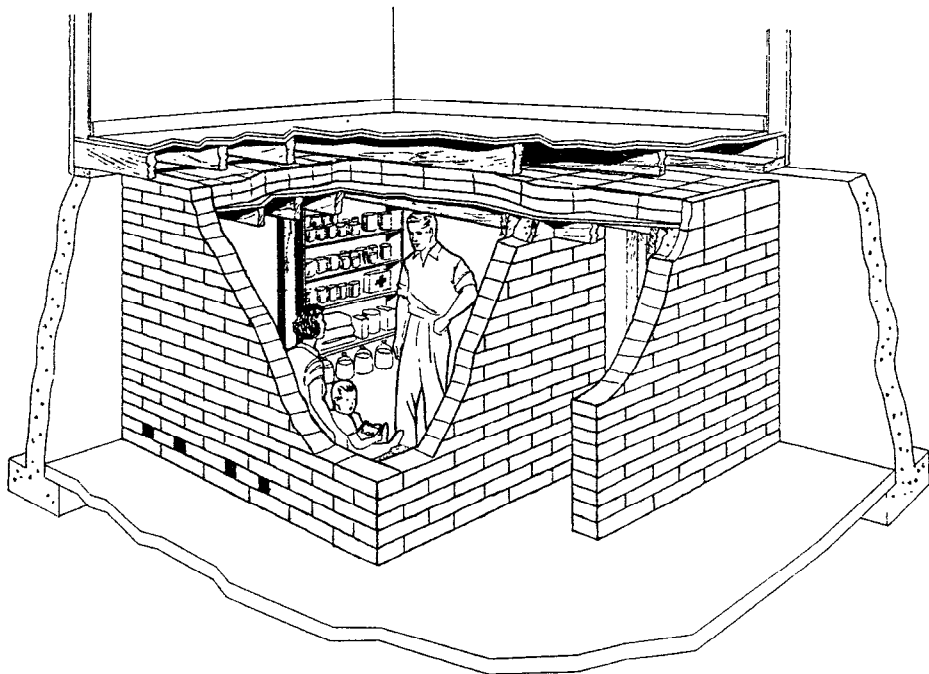

Figure 7—Basement Concrete Block Shelter

Solid concrete blocks, relatively heavy and dense, are used for this shelter. These blocks are sold in various sizes so it seldom is necessary to cut a block to fit.

Solid blocks are recommended because hollow blocks would have to be filled with concrete to give effective protection.

Bricks are an alternative. If they are used, the walls and roof should be 10 inches thick to give the same protection as the 8-inch solid concrete blocks.

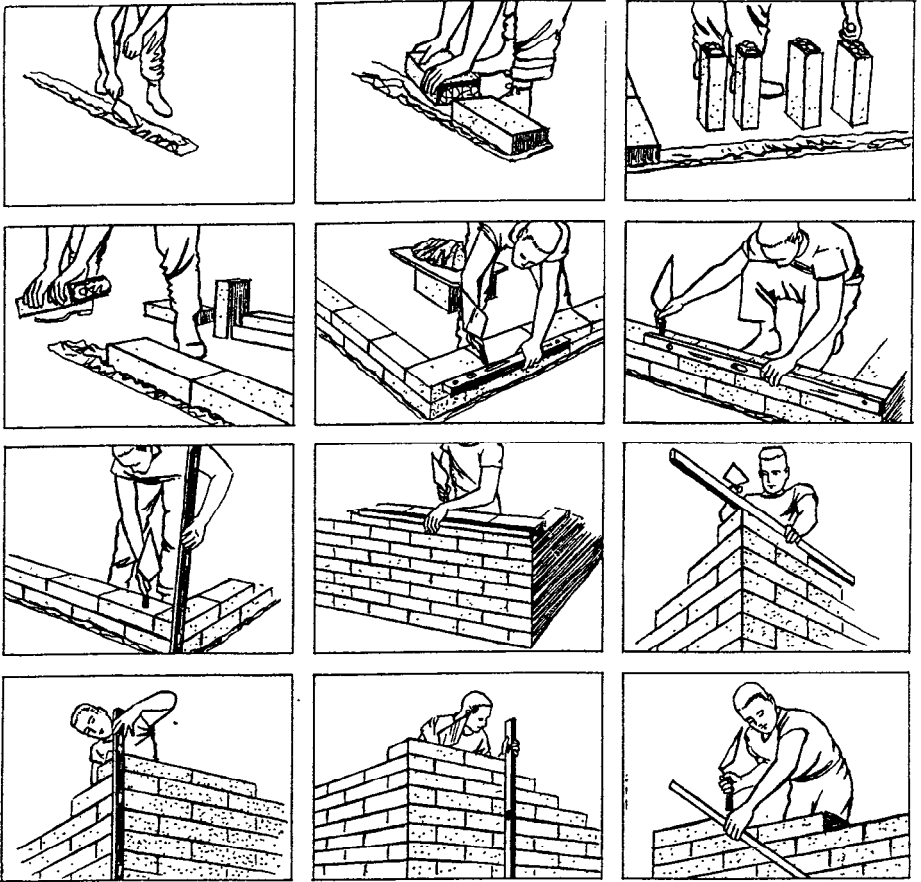

Figure 8

The illustrations in fig. 8 show how to lay a concrete block wall. More detailed instructions may be obtained from your local building supply houses and craftsmen. Other sources of information include the National Concrete Masonry Association, 38 South Dearborn Street, Chicago, Ill., the Portland Cement Association, 33 West Grand Avenue, Chicago, Ill., and the Structural Clay Products Association, Washington, D.C.

ABOVEGROUND DOUBLE-WALL SHELTER

An outdoor, aboveground fallout shelter also may be built with concrete blocks. (See fig. 9, double-wall shelter.) Most people would have to hire a contractor to build this shelter. Plans are on pages 22 and 23.

This shelter can be built in regions where water or rock is close to the surface, making it impractical to build an underground shelter.

Two walls of concrete blocks are constructed at least 20 inches apart. The space between them is filled with pit-run gravel or earth. The walls are held together with metal ties placed in the wet mortar as the walls are built.

The roof shown here (fig. 9) is a 6-inch slab of reinforced concrete, covered with at least 20 inches of pit-run gravel. An alternate roof, perhaps more within do-it-yourself reach, could be constructed of heavy wooden roof beams, overlaid with boards and waterproofing. It would have to be covered with at least 28 inches of pit-run gravel.

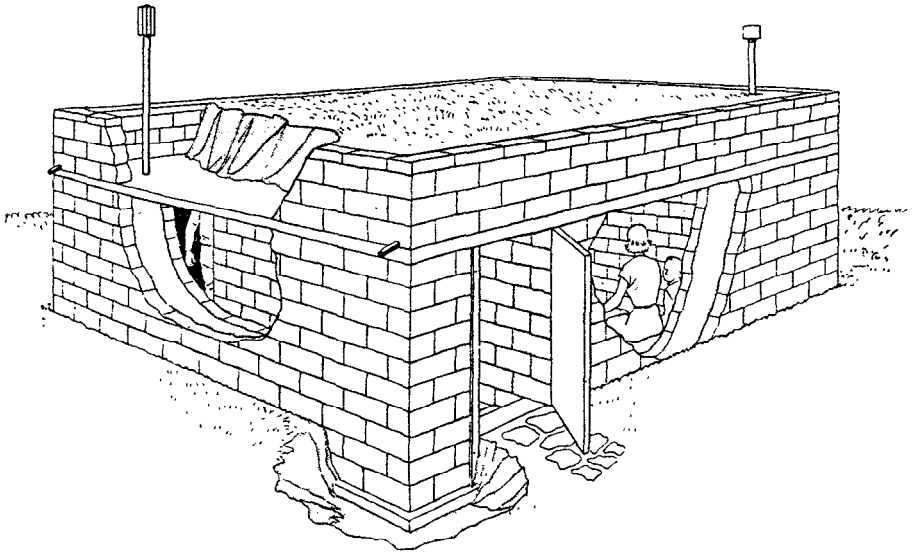

Figure 9.—Aboveground double-wall shelter

The materials for a double-wall shelter would cost about \$700. Contractors' charges would be additional. The shelter would provide almost absolute fallout protection.

PRE-SHAPED METAL SHELTER

Pre-shaped corrugated metal sections or pre-cast concrete can be used for shelters either above or below ground. These are particularly suitable for regions where water or rock is close to the surface. They form effective fallout shelters when mounded over with earth, as shown in figure 10.

Materials for this shelter would cost about \$700. A contractor probably would be required to help build it. His charges would be added to the cost of materials. This shelter, as shown on page 24, would provide almost absolute protection from fallout radiation. An alternate hatchway entrance, shown on page 25, would reduce the cost of materials \$50 to \$100.

The National Lumber Manufacturers Association, Washington, D. C., is developing plans to utilize specially treated lumber for underground shelter construction. The Structural Clay Products Institute, Washington, D.C., is working to develop brick and clay products suitable for shelter construction.

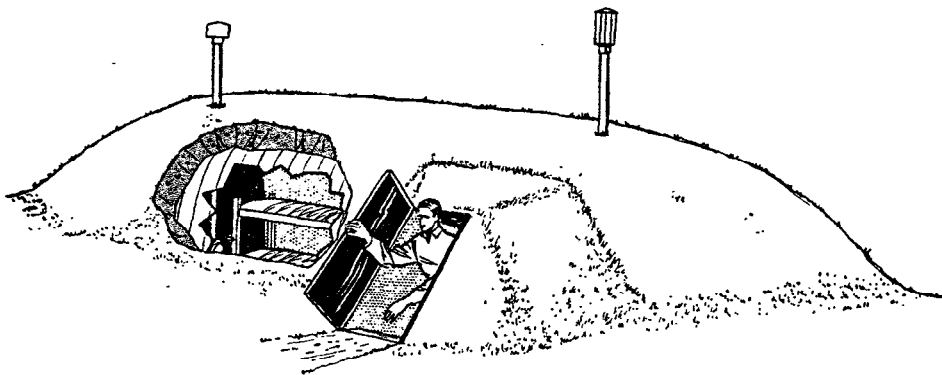

Figure 10.—Pre-shaped metal shelter

UNDERGROUND CONCRETE SHELTER

An underground reinforced concrete shelter can be built by a contractor for about \$1,000 to \$1,500, depending on the type of entrance. The shelter shown would provide almost absolute fallout protection.

The illustration (fig. 11) shows this shelter with the roof at ground level and mounded over. The same shelter could be built into an embankment or below ground level. Plans for the shelter, with either a stairway or hatchway entrance, are shown on pages 26 and 27.

Another type of shelter which gives excellent fallout protection can be built as an added room to the basement of a home under construction. It would add about \$500 to the total cost of the home. The shelter illustrated in figure 12 is based on such a room built in a new home in the Washington, D.C., area in the Spring of 1959.

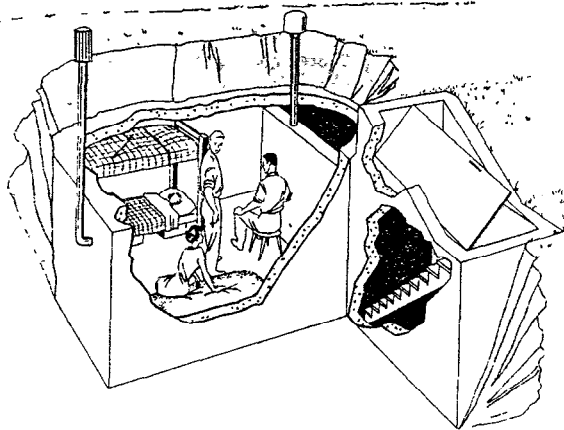

*Figure 11.—
Underground concrete shelter*

*Figure 12.—Concrete basement shelter
in new housing*

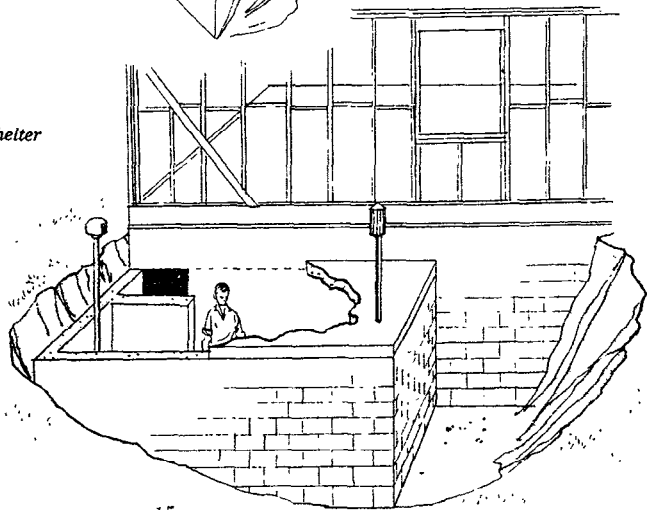

IMPORTANT CONSIDERATIONS common to each type of shelter are:

1. Arrangement of the entrance.
2. Ventilation.
3. Radio reception.
4. Lighting.

THE ENTRANCE must have at least one right-angle turn. Radiation scatters somewhat like light. Some will go around a corner. The rest continues in a straight line. Therefore, sharp turns in a shelter entrance will reduce radiation intensity inside the shelter.

VENTILATION is provided in a concrete block basement shelter by vents in the wall and by the open entrance. A blower may be installed to increase comfort.

A blower is essential for the double-wall shelter and for the underground shelters. It should provide not less than 5 cubic feet per minute of air per person. Vent pipes also are necessary (as shown in figs. 9, 10, and 11), but filters are not.

RADIO RECEPTION is cut down by the shielding necessary to keep out radiation. As soon as the shelter is completed a radio reception check must be made. It probably will be necessary to install an outside antenna, particularly to receive CONELRAD broadcasts.

LIGHTING is an important consideration. Continuous low-level lighting may be provided in the shelter by means of a 4-cell hot-shot battery to which is wired a 150-milliamperere flashlight-type bulb. Tests have shown that such a device, with a fresh battery, will furnish light continuously for at least 10 days. With a spare battery, a source of light for 2 weeks or more would be assured. A flashlight or electric lantern also should be available for those periods when a brighter light is needed. There should be a regular electrical outlet in the shelter as power may continue in many areas.

OTHER CONSIDERATIONS.—If there are outside windows in the basement corner where you build a shelter, they should be shielded as shown in the Appendix, page 29. Other basement windows should be blocked when an emergency threatens. Basement walls that project above the ground should be shielded as shown in the Appendix, page 29.

In these shelters the entrance should be not more than 2 feet wide. Bunks, or materials to build them, may have to be put inside the enclosure before the shelter walls are completed.

The basement or belowground shelters also will serve for tornado or hurricane protection.

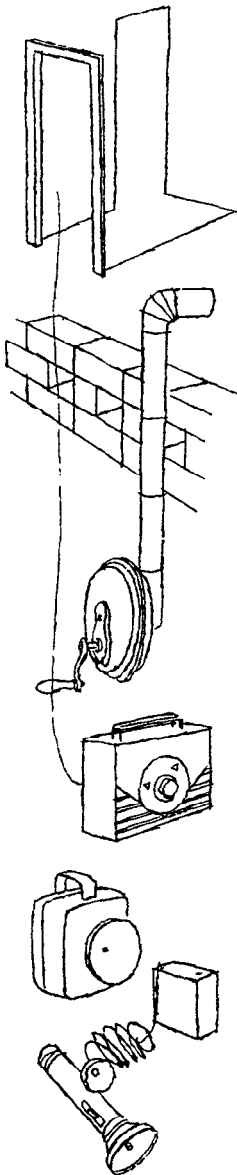

The radioactivity of fallout decays rapidly at first. *Forty-nine hours after an atomic burst the radiation intensity is only about 1 percent of what it was an hour after the explosion. But the radiation may be so intense at the start that one percent may be extremely dangerous.*

Therefore, civil defense instructions received over CONELRAD or by other means should be followed. A battery-powered radio is essential. When radiation meters suitable for home use are available they will be of value in locating that portion of the home which offers the best protection against fallout radiation. There is a possibility that battery-powered radios with built-in radiation meters may become available. One instrument thus would serve both purposes.

Your local civil defense will gather its own information and will receive broad information from State and Federal sources. It will tell you as soon as possible:

How long to stay in your shelter.

How soon you may go outdoors.

How long you may stay outside.

You should be prepared to stay in your shelter full time for at least several days and to make it your home for 14 days or longer. A checklist in the Appendix, (page 30) tells what is needed. Families with children will have particular problems. They should provide for simple recreation.

There should be a task for everyone and these tasks should be rotated. Part of the family should be sleeping while the rest is awake.

To break the monotony it may be necessary to invent tasks that will keep the family busy. Records such as diaries can be kept.

The survival of the family will depend largely on information received by radio. A record should be kept of the information and instructions, including the time and date of broadcast.

Family rationing probably will be necessary.

Blowers should be operated periodically on a regular schedule.

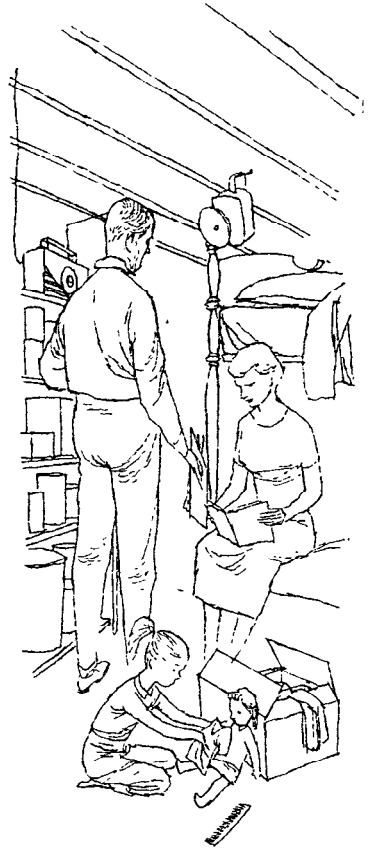

There will come a time in a basement shelter when the radiation has decayed enough to allow use of the whole basement. However, as much time as possible should be spent within the shelter to hold radiation exposure to a minimum.

The housekeeping problems of living in a shelter will begin as soon as the shelter is occupied. Food, medical supplies, utensils, and equipment, if not already stored in the shelter, must be quickly gathered up and carried into it.

After the family has settled in the shelter, the housekeeping rules should be spelled out by the adult in charge.

Sanitation in the confines of the family shelter will require much thought and planning.

Provision for emergency toilet facilities and disposal of human wastes will be an unfamiliar problem. A covered container such as a kitchen garbage pail might do as a toilet. A 10-gallon garbage can, with a tightly fitting cover, could be used to keep the wastes until it is safe to leave the shelter.

Water rationing will be difficult and should be planned carefully.

A portable electric heater is advisable for shelters in cold climates. It would take the chill from the shelter in the beginning. Even if the electric power fails after an attack, any time that the heater has been used will make the shelter that much more comfortable. Body heat in the close quarters will help keep up the temperature. Warm clothing and bedding, of course, are essential.

Open-flame heating or cooking should be avoided. A flame would use up air.

Some families already have held weekend rehearsals in their home shelters to learn the problems and to determine for themselves what supplies they would need.

IV. If An Attack Finds You Without A Prepared Shelter

Few areas, if any, are as good as prepared shelters but they are worth knowing about.

A family dwelling without a basement provides some natural shielding from fallout radiation. On the ground floor the radiation would be about half what it is outside. The best protection would be on the ground floor in the central part of the house.

A belowground basement can cut the fallout radiation to one-tenth of the outside level. The safest place is the basement corner least exposed to windows and deepest below ground

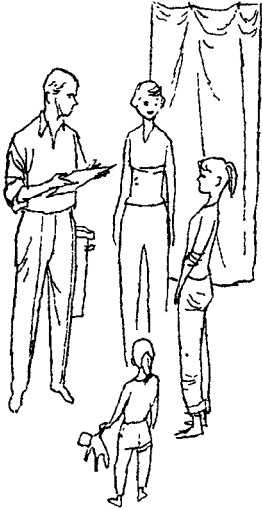

If there is time after the warning, the basement shielding could be improved substantially by blocking windows with bricks, dirt, books, magazines, or other heavy material.

V. Shelter In Apartment Buildings

Large apartment buildings of masonry or concrete provide better natural shelter than the usual family dwellings. In general, such apartments afford more protection than smaller buildings because their walls are thick and there is more space.

The central area of the ground floor of a heavily constructed apartment building, with concrete floors, should provide more fallout protection than the ordinary basement of a family dwelling. The basement of such an apartment building may provide as much natural protection as the specially constructed concrete block shelter recommended for the basement of a family dwelling.

The Federal Government is aiding local governments in several places to survey residential, commercial and industrial buildings to determine what fallout protection they would provide, and for how many people.

The problem for the city apartment dweller is primarily to plan the use of existing space. Such planning will require the cooperation of other occupants and of the apartment management. The space available should be identified and assigned to those who are to use it. The plan will work more smoothly if it is rehearsed. The owner of the building may find it necessary to modify the basement ventilation, water supply, and sanitation system.

You probably would have time to carry your family supplies from your apartment to the basement after an attack warning, before fallout arrives.

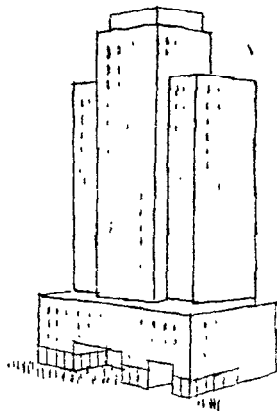

VI. Why Prepare A Shelter Now?

Fallout can threaten more people than blast and heat in a nuclear attack.

We do not want a war. We do not know whether there will be a war. But we know that forces hostile to us possess weapons that could destroy us if we were unready. These weapons create a new threat—radioactive fallout that can spread death anywhere.

That is why we must prepare.

No matter where you live a fallout shelter is necessary insurance. It will not be needed except in emergency. But in emergency it will be priceless—as priceless as your life

APPENDIX

CONTENTS

	<i>Page</i>
SECTION A—Construction drawings for fallout shelters ¹	21
Fig. 13—Basement, concrete block, 6 persons	21
Fig. 14—Aboveground, concrete block, double-wall, 6 persons, with concrete roof and alternate wood roof	22
Fig. 15—Further drawings of double-wall shelter	23
Fig. 16—Pre-shaped metal, 6 persons, stairway entrance	24
Fig. 17—Alternate hatchway entrance for the pre-shaped metal shelter	25
Fig. 18—Underground, concrete, 6 persons, hatchway entrance	26
Fig. 19—Alternate stairway entrance for the underground con- crete shelter	27
Fig. 20—Basement, concrete, 6 persons shelter, built into new construction	28
Fig. 21—Shielding for basement windows and walls	29
SECTION B—Shelter checklist	30
SECTION C—Suggestions for contracts	31

¹ Larger scale drawings may be obtained through your local civil defense organization, or from OCDM, Battle Creek, Mich.

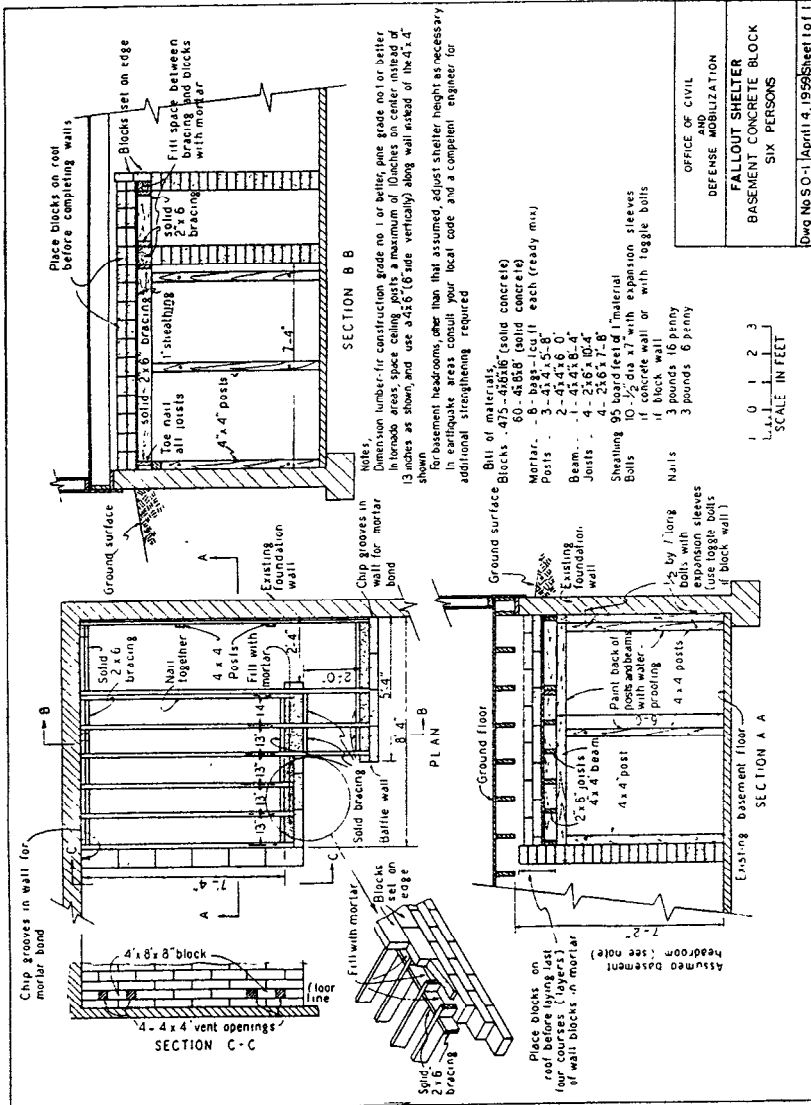
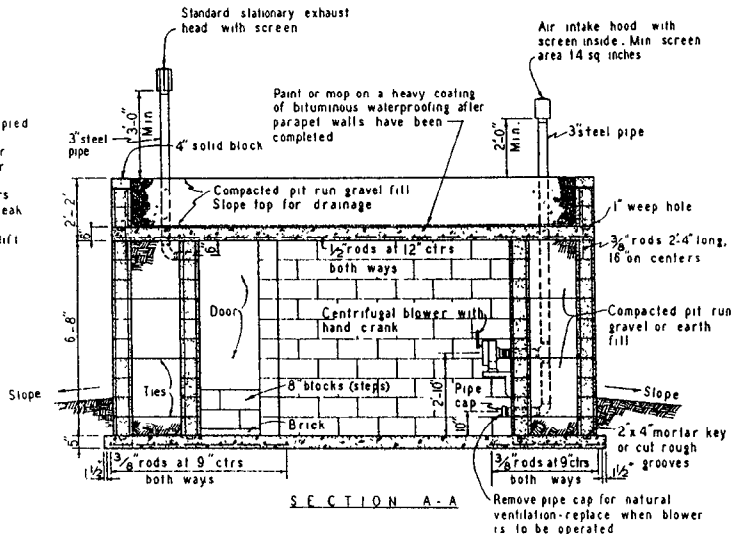

Figure 13

Notes,
 16-4 $\frac{1}{8}$ "x16" and 16-4 $\frac{1}{8}$ "x8" solid blocks must be provided for 8" thick wall to be laid up without mortar across the doorway after shelter is occupied
 Solid concrete blocks or brick may be used
 If brick is used for walls fill must be 6" thicker
 Build walls in 2'-0" lifts (heights) or less Let mortar harden for each lift
 Then compact the earth fill thoroughly in 4" layers
 Compaction to be done carefully so as not to break the mortar bond
 Protect the compacted soil from water for each lift
 Gravel may be compacted in 8" layers



0 1 2 3 4
 SCALE IN FEET

OFFICE OF CIVIL
 AND
 DEFENSE MOBILIZATION
 FALLOUT SHELTER
 ABOVEGROUND DOUBLE WALL
 SIX PERSONS
 Dwg No S O-3 April 14, 1959 Sheet 2 of 2

Figure 15

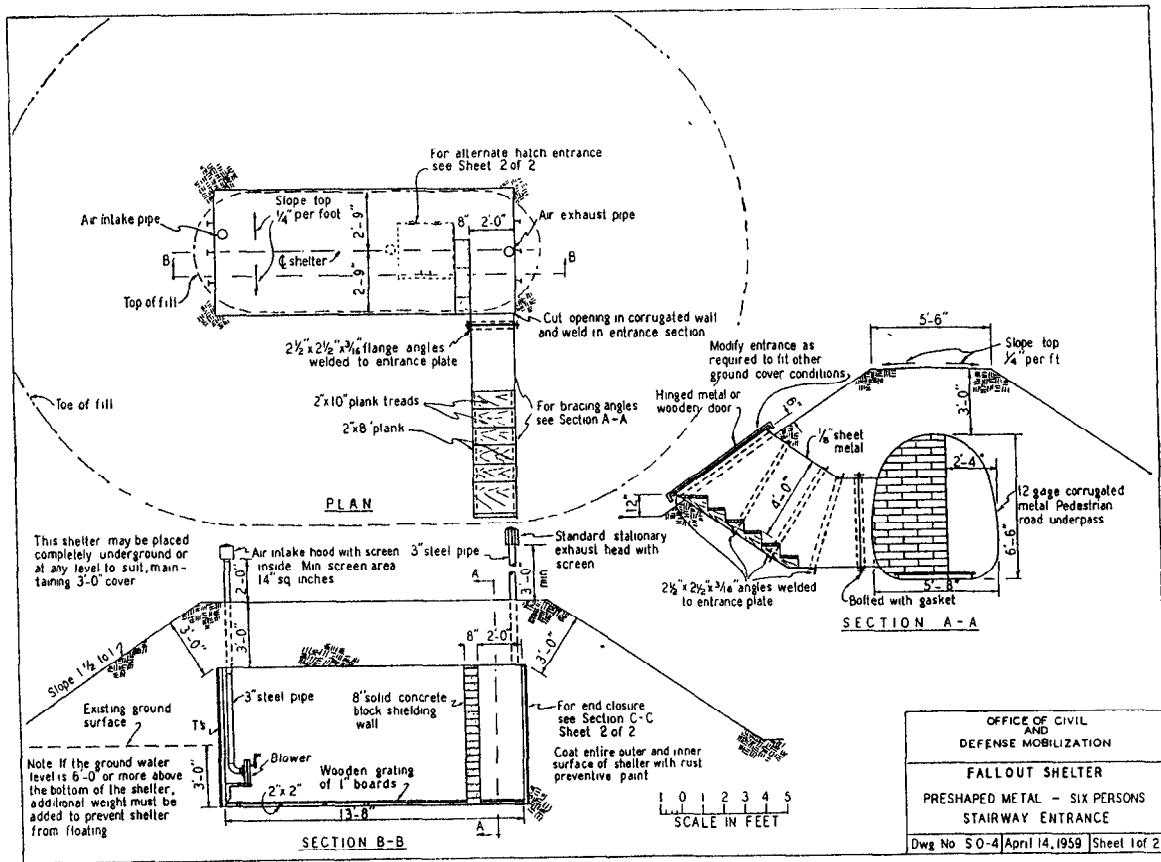

Figure 16

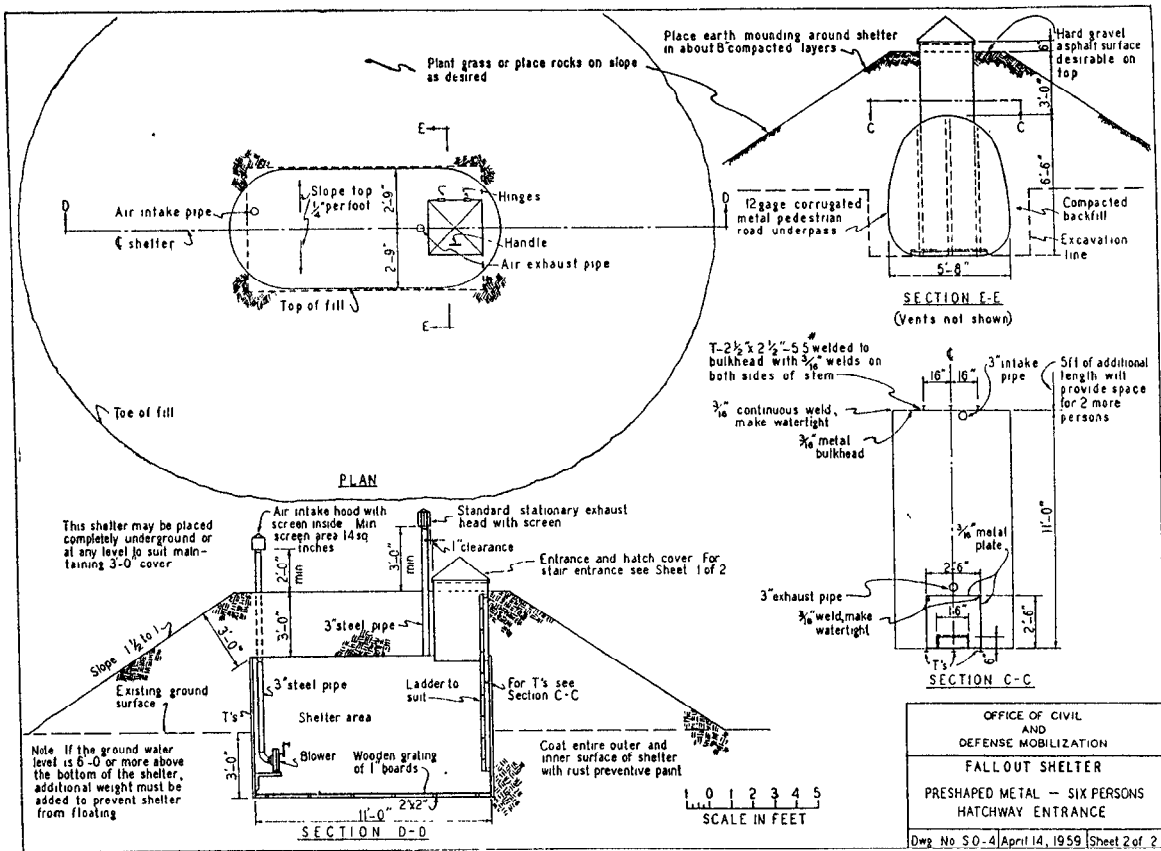

Figure 17

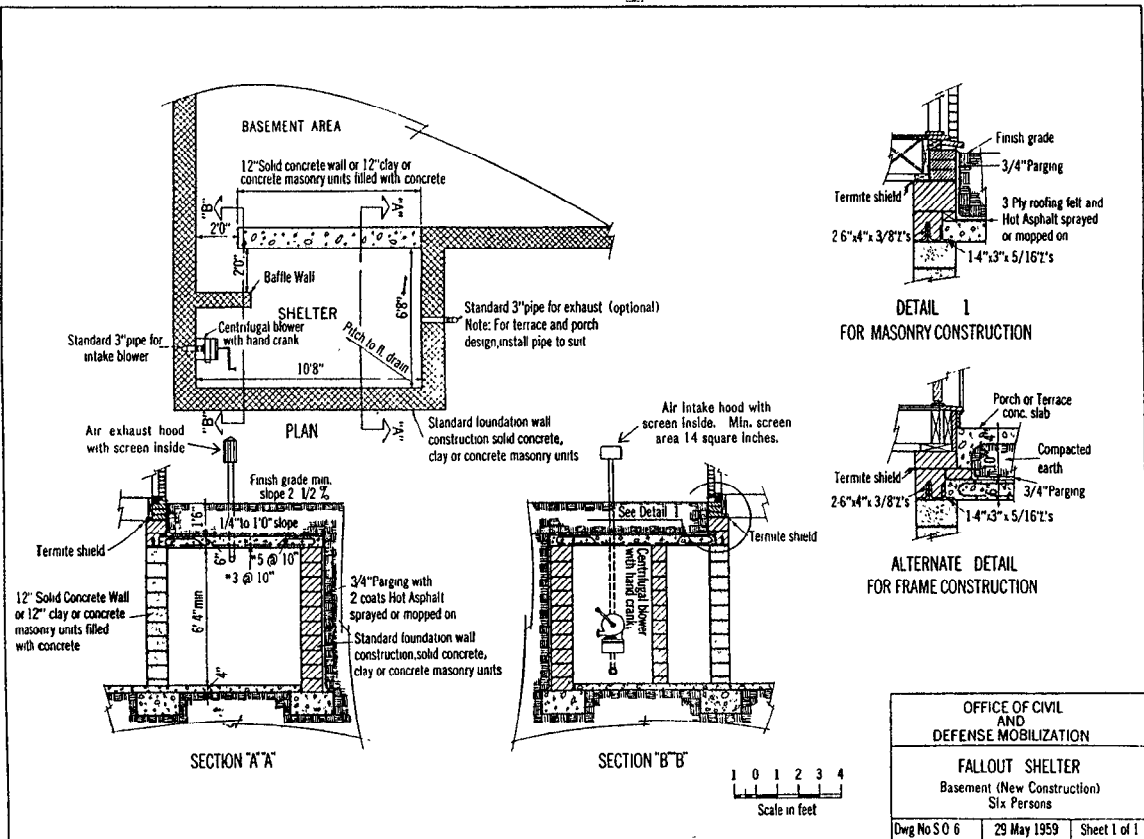
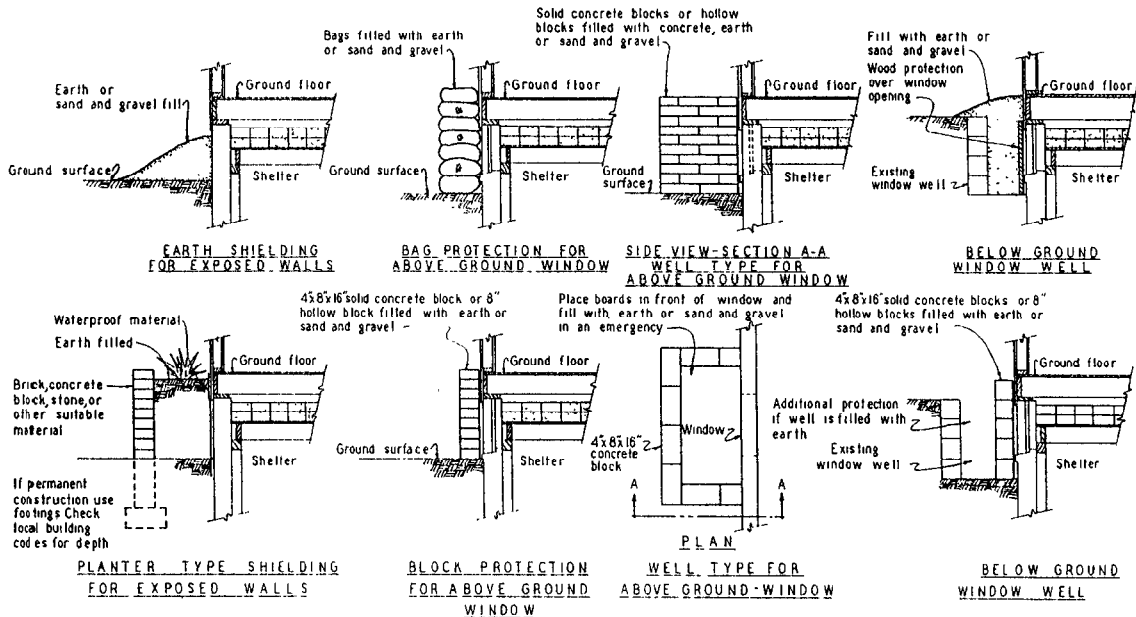

Figure 20



Note, Materials and methods shown for shielding aboveground windows can also be used for shielding exposed walls

1 0 1 2 3
SCALE IN FEET

OFFICE OF CIVIL AND DEFENSE MOBILIZATION
FALLOUT SHELTER SHIELDING OF BASEMENT WINDOWS AND WALLS
Dwg No S O 7 April 14, 1958 Sheet 1 of 1

Figure 21

SHELTER CHECKLIST

Section B

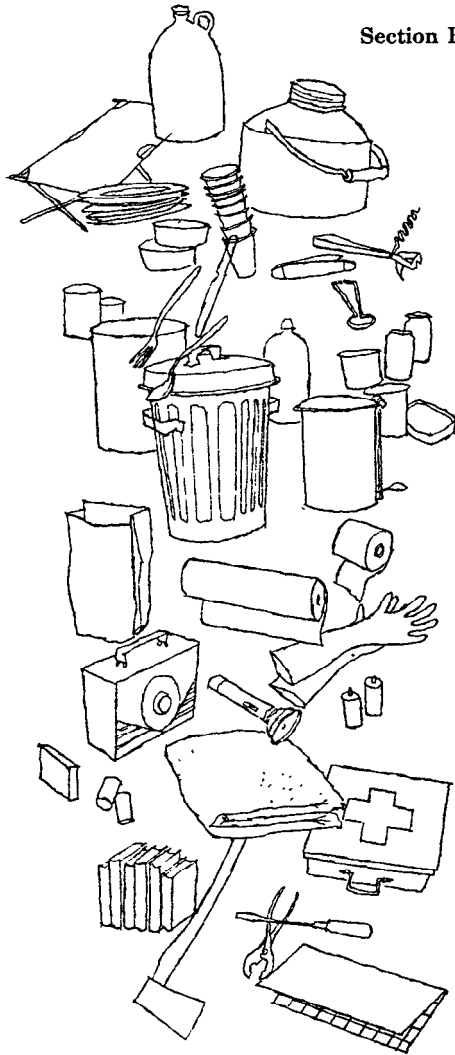

Food and cooking equipment:

- Water (2-week supply, a minimum of 7 gal. per person)
- Food (2-week supply)
- Eating utensils
- Paper plates, cups, and napkins (2-week supply)
- Openers for cans and bottles
- Pocket knife
- Special foods for babies and the sick

Supplies and equipment for sanitation:

- Can for garbage (20-gal.)
- Covered pail for toilet purposes
- Can for human wastes (10-gal.)
- Toilet tissue, paper towels, sanitary napkins, disposable diapers, ordinary and waterless soap
- Grocery bags, newspapers for soil bags
- Household chlorine (2 pt.) and DDT (1 qt. of 5% solution)
- Waterproof gloves

Shelter equipment:

- Battery radio with CONELRAD frequencies (640 or 1240) marked, and spare batteries for 2-week operation
- Home use radiation meters, when available
- Flashlights, electric lantern, and spare batteries for 2 weeks
- Clothing
- Bedding (rubber sheeting and special equipment for the sick)
- A first-aid kit and supplies listed in OCDM Leaflet L-2-12, *First Aid: Emergency Kit; Emergency Action*
- Writing material
- Reading material
- Screwdriver, pliers, and other household tools
- Games and amusements for children

Items outside the shelter but within reach:

- Cooking equipment (canned heat, or camp stove) and matches
- Home fire-fighting equipment
- Rescue tools

Medical Publications:

Any one of the following publications from a list provided by the Bureau of Health Education of the American Medical Association would be helpful when a physician is not available.

What To Do Until the Doctor Comes,
William Bolton, M.D., 145 pp. Cloth,
\$2. Reilly & Lee Co., 325 West
Huron St., Chicago, Ill.

Book of Health: "A Medical Encyclo-
pedia for Everyone," Randolph Lee
Clark, M.D., 768 pp., 1,400 illus-
trations. Cloth, \$10. Elsevier Press,
Inc., 402 Lovett Boulevard, Hous-
ton 6, Texas.

*Ship's Medicine Chest and First Aid
at Sea*. U.S. Public Health Service
and War Shipping Administration,
498 pp., illustrated, \$3.50. U.S.
Government Printing Office, Super-
intendent of Documents, Washing-
ton 25, D.C.

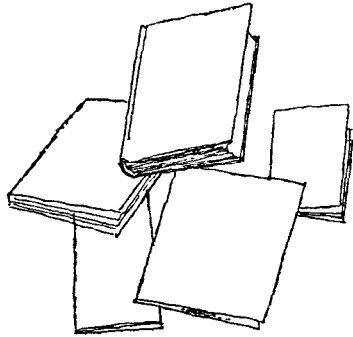

SUGGESTIONS FOR CONTRACTS

Section C

Following is a quick checklist of items to discuss with a contractor during negotiations:

1. Drainage from area around underground or outdoor shelters.
2. Protection against cave-in excavations.
3. Concrete strength and reinforcement.
4. Waterproofing.
5. Doors or hatches.
6. Ventilation.

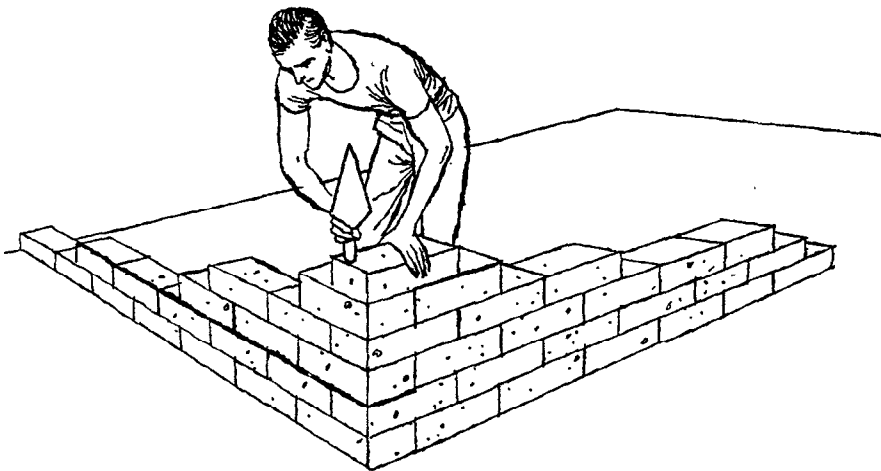

Let every American learn five simple steps to safety:

1. Attack warning signals and what they mean.
2. Your community plan for emergency action.
3. Protection from radioactive fallout.
4. First aid and home emergency preparedness.
5. The use of **CONELRAD-640** or **1240** on AM radio—for official directions.

U.S. Government Printing Office . 1959 501641--> 59

For sale by the Superintendent of Documents, U.S. Government Printing Office
Washington 25, D.C. - Price 10 cents