

ck-12

flexbook
next generation textbooks

CK-12 Physical Science Middle School



CK-12 Physical Science For Middle School

Jean Brainard, Ph.D.

Say Thanks to the Authors

Click <http://www.ck12.org/saythanks>

(No sign in required)



To access a customizable version of this book, as well as other interactive content, visit www.ck12.org

CK-12 Foundation is a non-profit organization with a mission to reduce the cost of textbook materials for the K-12 market both in the U.S. and worldwide. Using an open-content, web-based collaborative model termed the **FlexBook®**, CK-12 intends to pioneer the generation and distribution of high-quality educational content that will serve both as core text as well as provide an adaptive environment for learning, powered through the **FlexBook Platform®**.

Copyright © 2014 CK-12 Foundation, www.ck12.org

The names “CK-12” and “CK12” and associated logos and the terms “**FlexBook®**” and “**FlexBook Platform®**” (collectively “CK-12 Marks”) are trademarks and service marks of CK-12 Foundation and are protected by federal, state, and international laws.

Any form of reproduction of this book in any format or medium, in whole or in sections must include the referral attribution link <http://www.ck12.org/saythanks> (placed in a visible location) in addition to the following terms.

Except as otherwise noted, all CK-12 Content (including CK-12 Curriculum Material) is made available to Users in accordance with the Creative Commons Attribution-Non-Commercial 3.0 Unported (CC BY-NC 3.0) License (<http://creativecommons.org/licenses/by-nc/3.0/>), as amended and updated by Creative Commons from time to time (the “CC License”), which is incorporated herein by this reference.

Complete terms can be found at <http://www.ck12.org/terms>.

Printed: June 2, 2014

flexbook
next generation textbooks



AUTHOR

Jean Brainard, Ph.D.

EDITOR

Bradley Hughes, Ph.D.

Contents

1	The World of Science	1
1.1	What Is Science?	2
1.2	The Scope of Physical Science	11
1.3	References	16
2	Scientific Research and Technology	17
2.1	Scientific Investigation	18
2.2	Science Skills	25
2.3	Technology	37
2.4	References	44
3	Introduction to Matter	45
3.1	Properties of Matter	46
3.2	Types of Matter	53
3.3	Changes in Matter	61
3.4	References	67
4	States of Matter	69
4.1	Solids, Liquids, Gases, and Plasmas	70
4.2	Behavior of Gases	78
4.3	Changes of State	83
4.4	References	90
5	Atoms	91
5.1	Inside the Atom	92
5.2	History of the Atom	100
5.3	Modern Atomic Theory	107
5.4	References	112
6	Periodic Table	113
6.1	How Elements Are Organized	114
6.2	Classes of Elements	120
6.3	Groups of Elements	127
6.4	References	134
7	Chemical Bonding	135
7.1	Introduction to Chemical Bonds	136
7.2	Ionic Bonds	141
7.3	Covalent Bonds	147
7.4	Metallic Bonds	153
7.5	References	158
8	Chemical Reactions	159

8.1	Introduction to Chemical Reactions	160
8.2	Chemical Equations	165
8.3	Types of Chemical Reactions	170
8.4	Chemical Reactions and Energy	178
8.5	References	185
9	Chemistry of Carbon	186
9.1	Properties of Carbon	187
9.2	Hydrocarbons	193
9.3	Carbon and Living Things	203
9.4	Biochemical Reactions	212
9.5	References	217
10	Chemistry of Solutions	219
10.1	Introduction to Solutions	220
10.2	Solubility and Concentration	226
10.3	Acids and Bases	231
10.4	References	239
11	Nuclear Chemistry	240
11.1	Radioactivity	241
11.2	Radioactive Decay	247
11.3	Nuclear Energy	255
11.4	References	263
12	Motion	264
12.1	Distance and Direction	265
12.2	Speed and Velocity	270
12.3	Acceleration	276
12.4	References	281
13	Forces	282
13.1	What Is Force?	283
13.2	Friction	288
13.3	Gravity	295
13.4	Elastic Force	303
13.5	References	307
14	Newton's Laws of Motion	308
14.1	Newton's First Law	309
14.2	Newton's Second Law	313
14.3	Newton's Third Law	318
14.4	References	323
15	Fluid Forces	324
15.1	Pressure of Fluids	325
15.2	Buoyancy of Fluids	335
15.3	References	340
16	Work and Machines	341
16.1	Work	342
16.2	Machines	348
16.3	Simple Machines	355

16.4	Compound Machines	365
16.5	References	369
17	Introduction to Energy	371
17.1	Types of Energy	372
17.2	Forms of Energy	379
17.3	Energy Resources	386
17.4	References	395
18	Thermal Energy	397
18.1	Temperature and Heat	398
18.2	Transfer of Thermal Energy	403
18.3	Using Thermal Energy	409
18.4	References	416
19	Waves	417
19.1	Characteristics of Waves	418
19.2	Measuring Waves	426
19.3	Wave Interactions and Interference	432
19.4	References	438
20	Sound	439
20.1	Characteristics of Sound	440
20.2	Hearing Sound	448
20.3	Using Sound	454
20.4	References	459
21	Electromagnetic Radiation	460
21.1	Electromagnetic Waves	461
21.2	Properties of Electromagnetic Waves	466
21.3	The Electromagnetic Spectrum	470
21.4	References	479
22	Visible Light	480
22.1	The Light We See	481
22.2	Optics	490
22.3	Vision	501
22.4	References	506
23	Electricity	507
23.1	Electric Charge	508
23.2	Electric Current	515
23.3	Electric Circuits	522
23.4	Electronics	530
23.5	References	535
24	Magnetism	536
24.1	Magnets and Magnetism	537
24.2	Earth as a Magnet	544
24.3	References	551
25	Electromagnetism	552
25.1	Electricity and Magnetism	553

25.2	Using Electromagnetism	557
25.3	Generating and Using Electricity	563
25.4	References	569
26	Glossary	570
26.1	A	571
26.2	B	572
26.3	C	573
26.4	D	575
26.5	E	576
26.6	F	578
26.7	G	579
26.8	H	580
26.9	I	581
26.10	J	582
26.11	K	583
26.12	L	584
26.13	M	585
26.14	N	587
26.15	O	588
26.16	P	589
26.17	Q	591
26.18	R	592
26.19	S	594
26.20	T	596
26.21	U	597
26.22	V	598
26.23	W	599
26.24	X	600
26.25	Y	601
26.26	Z	602

CHAPTER

1

The World of Science

Chapter Outline

- 1.1 WHAT IS SCIENCE?
- 1.2 THE SCOPE OF PHYSICAL SCIENCE
- 1.3 REFERENCES



Have you ever experienced the thrill of an exciting fireworks display like this one? Fireworks were invented about 2000 years ago in China. But it wasn't until much later that people understood the science behind the technology.

Do you know why fireworks explode? Do you know what causes the brilliant bursts of light and the deep rumbling booms? In this FlexBook® digital resource, you'll find out the "hows" and "whys" of many things in the physical world around you—from the chemical reactions that cause fireworks to the waves of energy that travel through space from the sun.

Ghengis Fireworks (www.ghengisfireworks.com). www.flickr.com/photos/ghengisfireworks/9710103655/. CC BY 2.0.

1.1 What Is Science?

Lesson Objectives

- Define science.
- Explain how scientists use induction.
- Distinguish between scientific theories and laws.
- Describe milestones in the history of science.
- Identify contributions of women and minorities to science.

Lesson Vocabulary

- induction
- science
- scientific law
- scientific theory

Introduction

Understanding the "hows" and "whys" of the world is the goal of science. The term science comes from a Latin word that means "having knowledge." But science is as much about adding to knowledge as it is about having knowledge. Science is a way of thinking as well as a set of facts. **Science** can be defined as a way of learning about the natural world that is based on evidence and logic.

Thinking Like a Scientist

Are you like the teen in **Figure 1.1**? Do you ever wonder why things happen? Do you like to find out how things work? If so, then you are already thinking like a scientist. Scientists also wonder how and why things happen. They are curious about the world. To answer their questions, they make many observations. Then they use logic to draw general conclusions.

Induction

Drawing general conclusions from many individual observations is called **induction**. It is a hallmark of scientific thinking. To understand how induction works, think about this simple example. Assume you know nothing about gravity. In fact, pretend you've never even heard of gravity. Perhaps you notice that whenever you let go of an object it falls to the ground. For example, you drop a book, and it crashes to the floor. Your pencil rolls to the edge of the



FIGURE 1.1

Like a scientist, this teen wonders about how and why things happen. What do you wonder about?

desk and down it goes. You throw a ball into the air, and it falls back down. Based on many such observations (**Figure 1.2**), you conclude that all objects fall to the ground.

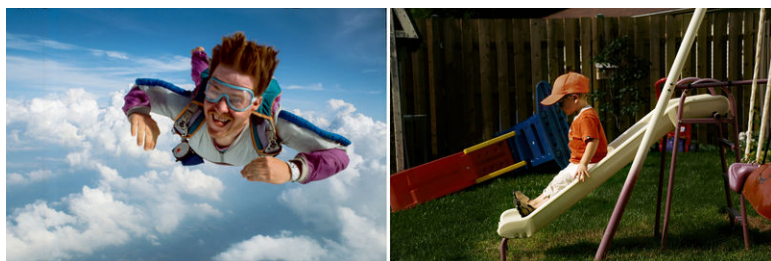

FIGURE 1.2

From skydivers in the air to kids on a playground slide, whatever goes up always comes back down. Or does it?

Now assume that someone gives you your first-ever helium balloon. You discover that it rises up into the air if you don't hold on to it. Based on this new observation, do you throw out your first idea about falling objects? No; you decide to observe more helium balloons and try to find other objects that fall up instead of down. Eventually, you come to a better understanding based on all your observations. You conclude that objects heavier than air fall to the ground but objects lighter than air do not. Your new conclusion is better because it applies to a wider range of observations. You can learn more about induction, including its limits, by watching the video at this link: http://www.youtube.com/watch?v=E1TpZ_HbK3M (5:39).

PASCAL'S WAGER

	EXIST	NOT
ACCEPT	HEAVEN	MISS OUT
REJECT	HELL	FUN

MEDIA

Click image to the left for more content.

How Science Advances

The above example shows how science generally advances. New evidence is usually used to improve earlier ideas rather than entirely replace them. In this way, scientists gradually refine their ideas and increase our understanding of the world. On the other hand, sometimes science advances in big leaps. This has happened when a scientist came up with a completely new way of looking at things. For example, Albert Einstein came up with a new view of gravity. He said it was really just a dent in the fabric of space and time.

Different conclusions can be drawn from the same observations, and it's not possible to tell which one is correct. For example, based on observations of the sun moving across the sky, people in the past couldn't tell whether the sun orbits Earth or Earth orbits the sun. Both models of the solar system are pictured in **Figure 1.3**. It wasn't until strong telescopes were invented that people could make observations that let them choose the correct idea. Not sure which idea is correct? You can learn more by watching the student-created video at this link: <http://www.youtube.com/watch?v=JcqdUq16S28> .

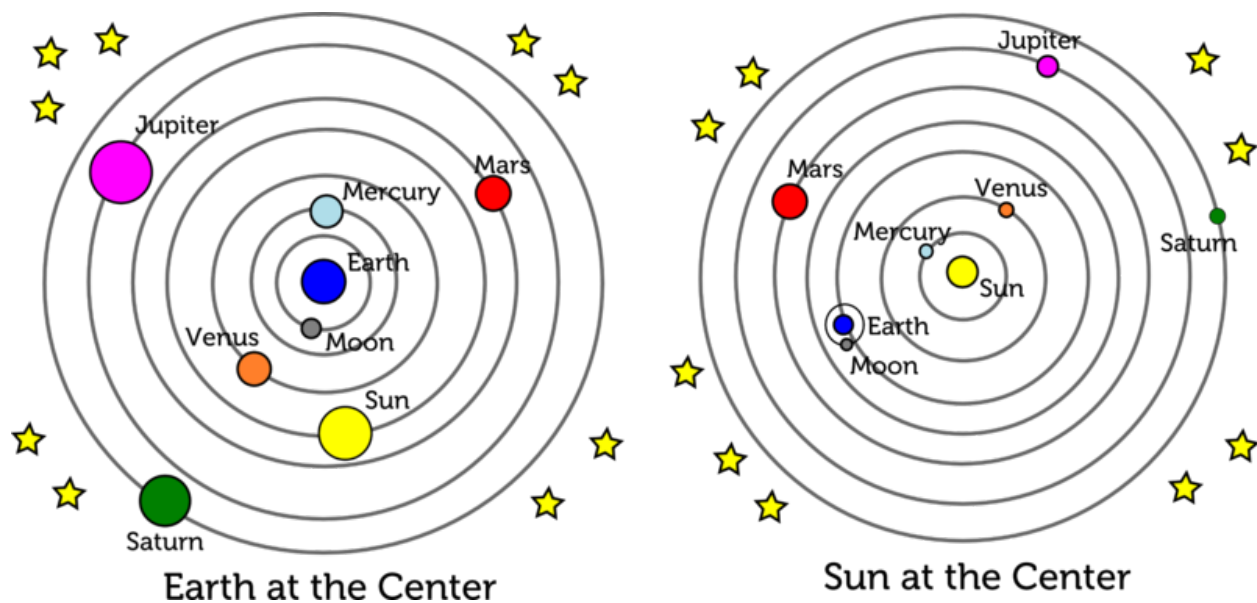

FIGURE 1.3

Both of these models could explain why the sun appears to move across the sky each day. Other observations were needed to decide which model is correct.

Theories and Laws

Some ideas in science gain the status of theories. Scientists use the term "theory" differently than it is used in everyday language. You might say, "I think the dog ate my homework, but it's just a theory." In other words, it's just one of many possible explanations for the missing work. However, in science, a theory is much more than that.

Scientific Theories

A **scientific theory** is a broad explanation that is widely accepted because it is supported by a great deal of evidence. An example is the kinetic theory of matter. According to this theory, all matter consists of tiny particles that are in constant motion. Particles move at different speeds in matter in different states. You can see this in **Figure 1.4** and at the following URL: http://preparatorychemistry.com/Bishop_KMT_frames.htm . Particles in solids move the least; particles in gases move the most. These differences in particle motion explain why solids, liquids, and gases look and act differently. Think about how ice and water differ, or how water vapor differs from liquid water. The kinetic theory of matter explains the differences. You can learn more about this theory in the chapter *States of Matter*.

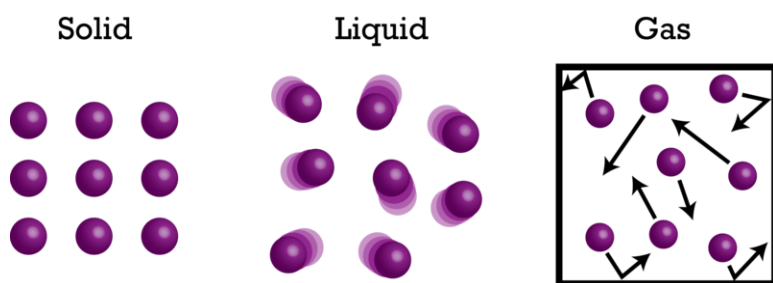

FIGURE 1.4

Why do you think particles move differently in different states of matter? (*Hint: What causes ice to melt?*)

Scientific Laws

Scientific laws are often confused with scientific theories, but they are not the same thing. A **scientific law** is a statement describing what always happens under certain conditions in nature. It answers "how" questions but not "why" questions. An example of a scientific law is Newton's law of gravity. It describes how all objects attract each other. It states that the force of attraction is greater for objects that are closer together or have more mass. However, the law of gravity doesn't explain why objects attract each other in this way. Einstein's theory of general relativity explains why. You can learn more about Newton's law of gravity and Einstein's theory in the chapter *Forces*, and at the following link: <http://www.youtube.com/watch?v=O-p8yZYxNGc> .

History of Science

People have wondered about the natural world for as long as there have been people. So it's no surprise that modern science has roots that go back thousands of years. The **Table 1.1** describes just a few milestones in the history of science. A much more detailed timeline is available at the link below. Often, new ideas were not accepted at first because they conflicted with accepted views of the world. A good example is Copernicus' idea that the sun is the center of the solar system. This idea was rejected at first because people firmly believed that Earth was the center of the solar system and the sun moved around it.

<http://www.sciencetimeline.net/>

TABLE 1.1: Timeline of Scientific Discovery

Date	Scientific Discovery
------	----------------------

TABLE 1.1: (continued)



Date	Scientific Discovery
<p data-bbox="159 233 264 260">3500 BC</p>  <p data-bbox="159 520 443 548"><i>Mesopotamian calendar</i></p>	<p data-bbox="824 233 1468 407">Several ancient civilizations studied astronomy. They recorded their observations of the movements of stars, the sun, and the moon. We still use the calendar developed by the Mesopotamians about 5500 years ago. It is based on cycles of the moon.</p>
<p data-bbox="159 558 248 585">600 BC</p>  <p data-bbox="159 884 237 911"><i>Thales</i></p>	<p data-bbox="824 558 1468 764">The ancient Greek philosopher Thales proposed that natural events, such as lightning and earthquakes, have natural causes. Up until then, people blamed such events on gods or other supernatural causes. Thales has been called the "father of science" for his ideas about the natural world.</p>
<p data-bbox="159 921 248 949">350 BC</p>  <p data-bbox="159 1283 261 1310"><i>Aristotle</i></p>	<p data-bbox="824 921 1468 1094">The Greek philosopher Aristotle argued that truth about the natural world can be discovered through observation and induction. This idea is called empiricism. Aristotle's empiricism laid the foundation for the methods of modern science.</p>
<p data-bbox="159 1320 394 1348">400 AD to 1000 AD</p>  <p data-bbox="159 1629 483 1656"><i>Early Chinese Seismograph</i></p>	<p data-bbox="824 1320 1468 1419">When Europe went through the Dark Ages, European science withered. However, in other places, science still flourished. For example:</p> <ul data-bbox="873 1451 1468 1661" style="list-style-type: none"> <li data-bbox="873 1451 1468 1549">• In North Africa, the scientist Alhazen studied light. He used experiments to test competing theories about light. <li data-bbox="873 1560 1468 1661">• In China, scientists invented compasses. They also invented seismographs to measure earthquakes. They studied astronomy as well.

TABLE 1.1: (continued)

Date	Scientific Discovery
<p>Mid-1500s to late 1600s</p>  <p><i>Galileo</i></p>	<p>The Scientific Revolution occurred in Europe. This was the beginning of modern Western science. Many scientific advances were made during this time.</p> <ul style="list-style-type: none"> • Copernicus proposed that the sun, not Earth, is the center of the solar system. • Galileo improved the telescope and made important discoveries in astronomy. He discovered evidence that supported Copernicus' theory. • Newton proposed the law of gravity.
<p>2001</p>  <p><i>Human Chromosomes</i></p>	<p>Many scientists around the world worked together to complete the genetic sequence of human chromosomes. This amazing feat will help scientists understand, and perhaps someday cure, genetic diseases.</p>

Women and People of Color in Science

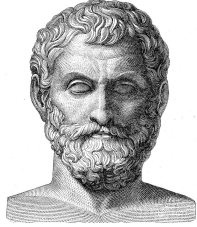
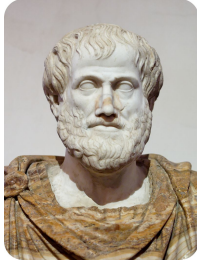
Throughout history, women and people of color have rarely had the same chances as white males for education and careers in science. But they have still made important contributions to science. The **Table 1.2** gives just a few examples of their contributions to physical science. More contributions are described at these links:

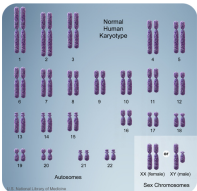
- <http://www.inventions.org/culture/science/women/index.html>
- <http://www1.umn.edu/ships/gender/giese.htm>
- <https://webfiles.uci.edu/mcbrown/display/faces.html>
- <http://library.thinkquest.org/20117/>

TABLE 1.2: A diversity of people has contributed to physical science.

Contributor	Description
<p><u>Marie Curie (1867-1934)</u></p> 	<p>Marie Curie was the first woman to win a Nobel Prize. She won the 1903 Nobel Prize in physics for the discovery of radiation. She won the 1911 Nobel Prize in chemistry for discovering the elements radium and polonium.</p>

TABLE 1.2: (continued)







Contributor	Description
<p><u>Lise Meitner (1878-1968)</u></p> 	<p>Lise Meitner was one of the scientists who discovered nuclear fission. This is the process that creates enormous amounts of energy in nuclear power plants.</p>
<p><u>Irene Joliot-Curie (1897–1956)</u></p> 	<p>Irene Joliot-Curie, daughter of Marie Curie, won the 1935 Nobel prize in chemistry, along with her husband, for the synthesis of new radioactive elements.</p>
<p><u>Maria Goeppert-Mayer (1906–1972)</u></p> 	<p>Maria Goeppert-Mayer was a co-winner of the 1963 Nobel prize in physics for discoveries about the structure of the nucleus of the atom.</p>
<p><u>Ada E. Yonath (1939–present)</u></p> 	<p>Ada E. Yonath was a co-winner of the 2009 Nobel prize in chemistry. She made important discoveries about ribosomes, the structures in living cells where proteins are made.</p>

TABLE 1.2: (continued)

Contributor	Description
<p><u>Shirley Ann Jackson (1946-present)</u></p> 	<p>Shirley Ann Jackson earned a doctoral degree in physics. She became the chair of the US Nuclear Regulatory Commission.</p>
<p><u>Ellen Ochoa (1958-present)</u></p> 	<p>Ellen Ochoa is an inventor, research scientist, and NASA astronaut. She has flown several space missions.</p>

Lesson Summary

- Science is a way of learning about the natural world that is based on evidence and logic. The hallmark of scientific thinking is induction.
- A scientific theory is a broad explanation that is widely accepted because it is supported by a great deal of evidence. A scientific law is a statement describing what always happens under certain conditions in nature.
- Modern science has roots that go back thousands of years. Diverse people from around the world have contributed to the evolution of science.
- Women and minorities have rarely had the same chances in science as white males, but they still have made important contributions.

Lesson Review Questions

Recall

1. Define science.
2. What is induction?
3. State the contributions of Thales and Aristotle to the evolution of science.
4. What was the Scientific Revolution?

Apply Concepts

5. Use induction to draw a logical conclusion based on **Table 1.3**.

TABLE 1.3: Freezing Point of Substances

Substance	Temperature at Freezing (°C)
Pure water (1 cup water)	0
Salt water (1 cup water + 5 grams table salt)	-4
Sugar water (1 cup water + 6 grams sugar)	-5

6. What observation would require you to revise your conclusion in question 5?

Think Critically

7. Compare and contrast scientific theories and scientific laws. Give an example of each.

Points to Consider

Most of the scientists mentioned in this lesson are physical scientists.

- Based on their work, what do you think is the subject matter of physical science?
- What are some questions that physical scientists might investigate?

1.2 The Scope of Physical Science

Lesson Objectives

- Define physical science.
- Explain the relevance of physical science to everyday life.
- Describe examples of careers in physical science.

Lesson Vocabulary

- chemistry
- physical science
- physics

Introduction

Physical science covers a lot of territory. It's easier to describe by what it is not than by what it is. Basically, it's all science that is not life science.

Defining Physical Science

Physical science can be defined as the study of matter and energy. Matter refers to all the "stuff" that exists in the universe. It includes everything you can see and many things that you cannot see, including the air around you. Energy is what gives matter the ability to move and change. Energy can take many forms, such as electricity, heat, and light. Physical science can be divided into chemistry and physics. Chemistry focuses on matter and energy at the scale of atoms and molecules. Physics focuses on matter and energy at all scales, from atoms to outer space.

Chemistry

Chemistry is the study of the structure, properties, and interactions of matter. Important concepts in chemistry include physical changes, such as water freezing, and chemical reactions, such as fireworks exploding. Chemistry concepts can answer all the questions on the left page of the notebook in **Figure 1.5**. Do you know the answers?

Physics

Physics is the study of energy and how it interacts with matter. Important concepts in physics include motion, forces such as magnetism and gravity, and different forms of energy. Physics concepts can answer all the questions on the right page of the notebook in **Figure 1.5**.

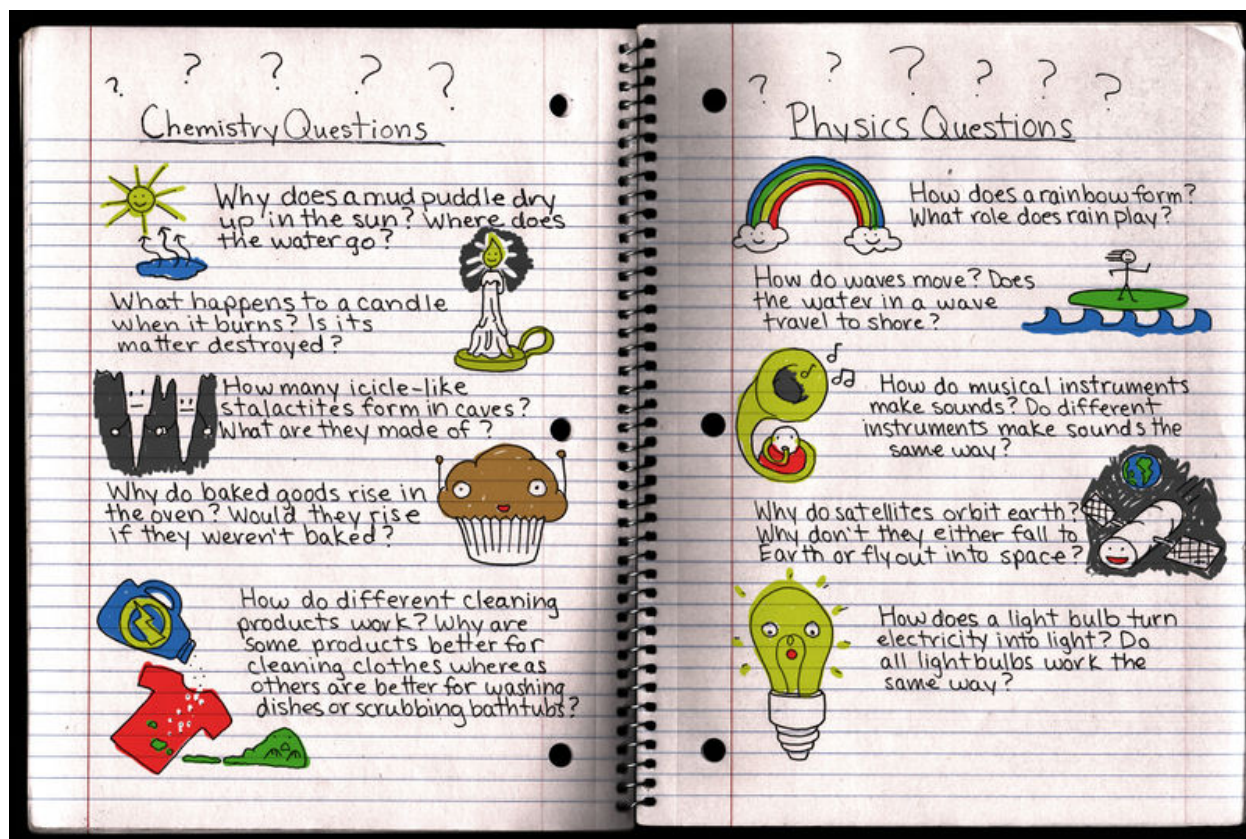

FIGURE 1.5

Using what you already know, try to answer each of these questions. Revisit your answers after you read about the relevant concepts in later chapters.

Physical Science and You

Physical science explains much of what you observe and do in your daily life. In fact, you depend on physical science for almost everything that makes modern life possible. You couldn't drive a car, text message, or send a tweet without decades of advances in chemistry and physics. You wouldn't even be able to turn on a light. **Figure 1.6** shows some other examples of common activities that depend on advances in physical science. You'll learn the "hows" and "whys" about them as you read the rest of this book.

Careers in Physical Science

People with training in physical science are employed in a variety of places. There are many career options. Just four are described in **Figure 1.7**. Many more are described at the URL below. Do any of these careers interest you?

- http://diplomaguide.com/article_directory/sh/page/Physical%20Science/sh/Job_Titles_and_Careers_List.html

A bike lets you travel faster and farther than you can travel by foot.



The air conditioner turns on when you lower the thermostat.

A microwave heats food very quickly.



Lenses correct vision problems.



Mixing different colors of paint produces new colors.

FIGURE 1.6

All these activities involve matter and energy. Can you explain how or why?

Lesson Summary

- Physical science is the study of matter and energy. It includes chemistry, which focuses on matter, and physics, which focuses on energy.
- Physical science explains everyday observations and actions. Its advances make modern life possible.
- There are many career options in physical science. Examples include pharmacist and surveyor.

Lesson Review Questions

Recall

1. Define physical science.
2. What is the focus of chemistry?
3. Describe an example of a career in physical science.

A pharmacist prepares and dispenses medicines and advises patients. Pharmacists work in drug stores, hospitals, and other settings. To become a pharmacist requires 6 years of college.



A forensic scientist helps solve crimes by gathering and analyzing clues. Forensic scientists work in police departments, government agencies, and other settings. To become a forensic scientist requires at least 4 years of college.



An automotive mechanic diagnoses and repairs car and truck problems. Mechanics work in car dealerships and repair shops. To become an automotive mechanic generally takes between 6 months and 2 years of technical training.



A surveyor measures and records features on Earth's surface. Surveyors work for architects, engineers, and government agencies. Becoming a surveyor usually requires 4 years of college.

FIGURE 1.7

How might chemistry or physics be involved in each of these careers?

Apply Concepts

4. What practical question might be answered with physics concepts?

Think Critically

5. Energy is needed to make matter move. Explain how you use energy to ride a bike uphill. What force allows you to coast downhill without peddling?

Points to Consider

Figure 1.7 describes several careers in physical science. Other careers in physical science include research scientist and engineer.

- What do you think research scientists do?
- How do you think the work of engineers differs from that of research scientists?

For **Table 1.1**, from top to bottom:

- User: Ceridwen/Wikimedia Commons. http://commons.wikimedia.org/wiki/File:Piedra_del_Sol.jpg . Public Domain.

- Ernst Wallis et al. http://commons.wikimedia.org/wiki/File:Illustrerad_Verldshistoria_band_I_III_107.jpg . Public Domain.
- Photographer: Marie-Lan Nguyen (User:Jastrow/Wikimedia Commons). http://commons.wikimedia.org/wiki/File:Aristotle_Altemps_Inv8575.jpg . Public Domain.
- User:deror_avi/Wikimedia Commons. http://commons.wikimedia.org/wiki/File:Seismograph_IMG_5401.JPG . The copyright holder of this file allows anyone to use it for any purpose, provided that the copyright holder is properly attributed. Redistribution, derivative work, commercial use, and all other use is permitted.
- Courtesy of NASA. http://solarsystem.nasa.gov/multimedia/download-detail.cfm?DL_ID=422 . Public Domain.
- Courtesy of US National Library of Medicine. <http://ghr.nlm.nih.gov/handbook/illustrations/normalkaryotype> . Public Domain.

For **Table 1.2**, from top to bottom:

- <http://commons.wikimedia.org/wiki/File:Mariecurie.jpg> . Public Domain.
- Courtesy of the Master and Fellows of Churchill College, Cambridge, England. http://commons.wikimedia.org/wiki/File:Lise_Meitner12.jpg . Public Domain.
- Courtesy of the Nobel Foundation. <http://commons.wikimedia.org/wiki/File:Joliot-curie.jpg> . Public Domain.
- Courtesy of the Nobel Foundation. <http://commons.wikimedia.org/wiki/File:Mayer.jpg> . Public Domain.
- Renato Araújo / ABr. http://commons.wikimedia.org/wiki/File:Ada_Yonath_0817111040_RNA6496Agencia_Brasil.JPG CC BY 3.0.
- NRC File Photo, courtesy of the United States Nuclear Regulatory Commission. <http://www.flickr.com/photos/nrcgov/6795959929/> . Public Domain.
- Courtesy of NASA. <http://images.jsc.nasa.gov/luceneweb/caption.jsp?photoId=S90-45857> . Public Domain.

1.3 References

1. Vinay Shivakumar, modified by CK-12 Foundation. <http://www.flickr.com/photos/vinayshivakumar/3280705941/> . CC BY 2.0
2. Skydiver: Philip Leara; Slide: Jacky W. (Flickr: Mediatejack). Skydiver: <http://www.flickr.com/photos/philleara/7046670573/>; Slide: <http://www.flickr.com/photos/mediatejack/2075620374/> . CC BY 2.0
3. Joy Sheng. [CK-12 Foundation](#) . CC BY-NC 3.0
4. Christopher Auyeung. [CK-12 Foundation](#) . CC BY-NC 3.0
5. Laura Guerin. [CK-12 Foundation](#) . CC BY-NC 3.0
6. Bike: Flickr:andy_c; Thermostat: Robert Lopez; Microwave: Chris Kelly; Glasses: Camera Eye Photography; Paint: Jill. Bike: <http://www.flickr.com/photos/11276503@N00/1262355794/>; Thermostat: [CK-12 Foundation](#); Microwave: <http://www.flickr.com/photos/ckelly/4846654926/>; Glasses: <http://www.flickr.com/photos/22605449@N06/6628934195/>; Paint: <http://www.flickr.com/photos/lij/5869676745/> . Bike: CC BY 2.0; Thermostat: CC BY-NC 3.0; Microwave: CC BY 2.0; Glasses: CC BY 2.0; Paint: CC BY 2.0
7. Pharmacist: Courtesy of Rhoda Baer, National Cancer Institute; Forensic scientist: Courtesy of National Cancer Institute; Mechanic: User:Interior/Wikipedia; Surveyor: Courtesy of Photographers Mate 1st Class Brien Aho, U.S. Navy. Pharmacist: http://commons.wikimedia.org/wiki/File:Woman_consults_with_pharmacist_%281%29.jpg; Forensic scientist: http://commons.wikimedia.org/wiki/File:Scientist_looking_thorough_microscope.jpg; Mechanic: http://commons.wikimedia.org/wiki/File:Auto_Mechanic.jpg; Surveyor: http://commons.wikimedia.org/wiki/File:Us_land_survey_officer.jpg . Public Domain

CHAPTER 2**Scientific Research and Technology****Chapter Outline**

- 2.1 SCIENTIFIC INVESTIGATION**
- 2.2 SCIENCE SKILLS**
- 2.3 TECHNOLOGY**
- 2.4 REFERENCES**

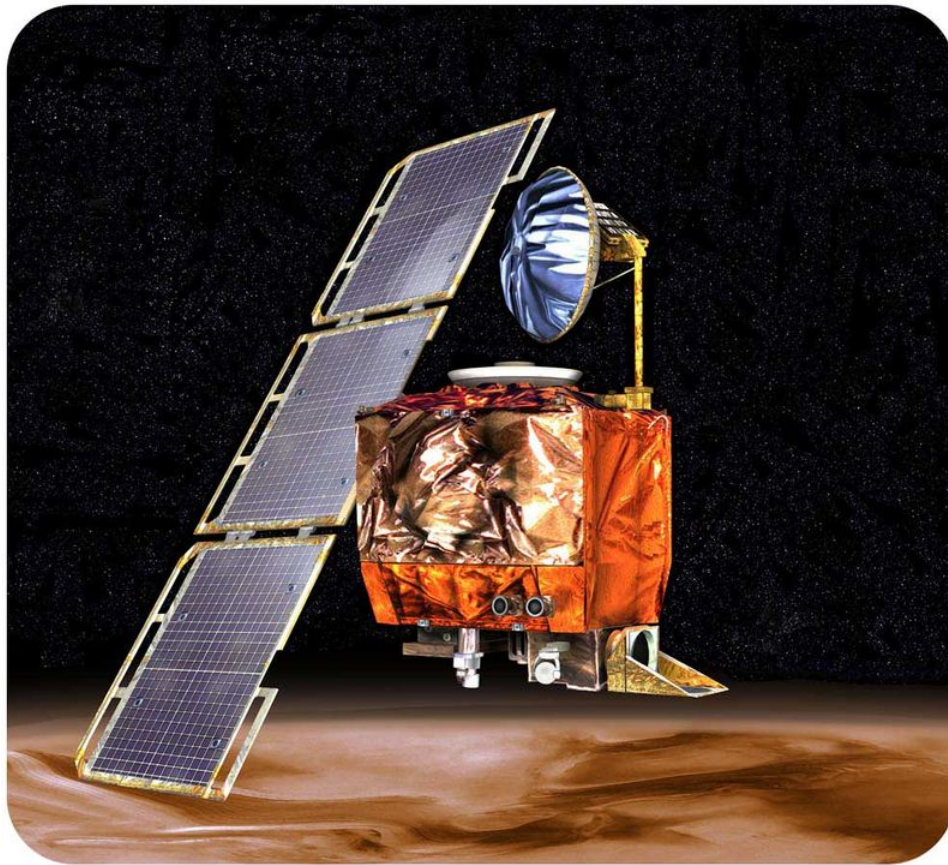

In 1999, NASA's Mars Climate Orbiter, pictured here, burned up as it passed through Mars' atmosphere. The satellite was programmed to orbit Mars at high altitude and gather climate data. Instead, the Orbiter flew too low and was lost almost as soon as it reached the red planet. What happened to the Orbiter? The answer is human error. The flight system software on the Orbiter was written using scientific units of measurement. The ground crew was entering data using the common English system of units.

The example of the Mars Climate Orbiter shows the importance of using a standard system of measurement in science and technology. Measurement is just one of the basic skills needed in these fields. What other skills are needed? In this chapter, you'll find out.

Image courtesy of NASA. commons.wikimedia.org/wiki/File:Mars_Climate_Orbiter_2.jpg. Public Domain.

2.1 Scientific Investigation

Lesson Objectives

- List the steps of a scientific investigation.
- Describe the relationship of ethics to scientific research.

Lesson Vocabulary

- control
- ethics
- experiment
- field study
- hypothesis
- manipulated variable
- observation
- replication
- responding variable

Introduction

Investigation is at the heart of science. It is how scientists do research. Scientific investigations produce evidence that helps answer questions and solve problems. If the evidence cannot provide answers or solutions, it may still be useful. It may lead to new questions or problems for investigation. As more knowledge is discovered, science advances.

Steps of a Scientific Investigation

Scientists investigate the world in many ways. In different fields of science, researchers may use different methods and be guided by different theories and hypotheses. However, most scientists, including physical scientists, usually follow the general approach shown in **Figure 2.1**. This approach typically includes the following steps:

- Identify a research question or problem.
- Form a hypothesis.
- Gather evidence, or data, to test the hypothesis.
- Analyze the evidence.
- Decide whether the evidence supports the hypothesis
- Draw conclusions.
- Communicate the results.

Scientists may follow these steps in a different sequence. Or they may skip or repeat some of the steps. Which steps are repeated in **Figure 2.1**?

Asking Questions

A scientific investigation begins with a question or problem. Often, the question arises because a scientist is curious about something she has observed. An **observation** is any information that is gathered with the senses. People often have questions about things they see, hear, or observe in other ways. For example, a teen named Tara has a bracelet with a magnetic clasp, like the one shown in **Figure 2.2**. Tara has noticed that the two magnets in the clasp feel harder to pull apart on cold days than on warm days. She wonders whether temperature affects the strength of a magnet.

Forming Hypotheses and Making Predictions

Tara is curious. She decides to investigate. She begins by forming a hypothesis. A **hypothesis** is a potential answer to a question that can be tested by gathering information. If it isn't possible to gather evidence to test an answer, then it cannot be used as a scientific hypothesis. In fact, the question it addresses may not even be answerable by science. For example, in the children's television show *Sesame Street*, there was a large Snuffalufagus (kind of like an elephant). But Snuffy would disappear whenever people came around. So if someone said "Is there a Snuffy on Sesame Street?," that question would be unanswerable by science, since there isn't any test that can be performed—because Snuffy would disappear as soon as a scientist showed up. Can you think of other examples of questions outside the realm of science?

This important distinction, that evidence taken in by observation is experimented on by a scientist, is what separates legitimate science from other things which may pretend to be science. Fields which claim to be scientific but don't use the scientific method are called "pseudoscience." If a person can't gather data through some sort of instrument or sense information, they can't form a scientific conclusion. If there is no way to prove the hypothesis false, there is no scientific claim either. For example, if a friend told you that Snuffy visited him every day, but he was invisible whenever anyone walked into the room, this claim is not scientific, *since there is no way to prove him false*.

Developing a hypothesis may require creativity as well as reason. However, in Tara's case, the hypothesis is simple. She hypothesizes that a magnet is stronger at lower temperatures. Based on her hypothesis, Tara makes a prediction. If she cools a magnet, then it will pick up more metal objects, such as paper clips. Predictions are often phrased as "if-then" statements like this one. Is Tara's prediction correct? She decides to do an experiment.

Doing Experiments

An **experiment** is a controlled scientific study of specific variables. A variable is a factor that can take on different values. There must be at least two variables in an experiment. They are called the manipulated variable and the responding variable.

- The **manipulated variable** (also called the "independent variable") is a factor that is changed by the researcher. For example, Tara will change the temperature of a magnet. Temperature is the manipulated variable in her experiment.
- The **responding variable** (also called the "dependent variable") is a factor that the researcher predicts will change if the manipulated variable changes. Tara predicts the number of paper clips attracted by the magnet will be greater at lower temperatures. Number of paper clips is the responding variable in her experiment.

Tara wonders what other variables might affect the strength of a magnet. She thinks that the size and shape of a magnet might affect its strength. These are variables that must be controlled. A **control** is a variable that is held constant so it won't influence the outcome of an experiment. By using the same magnet at different temperatures,

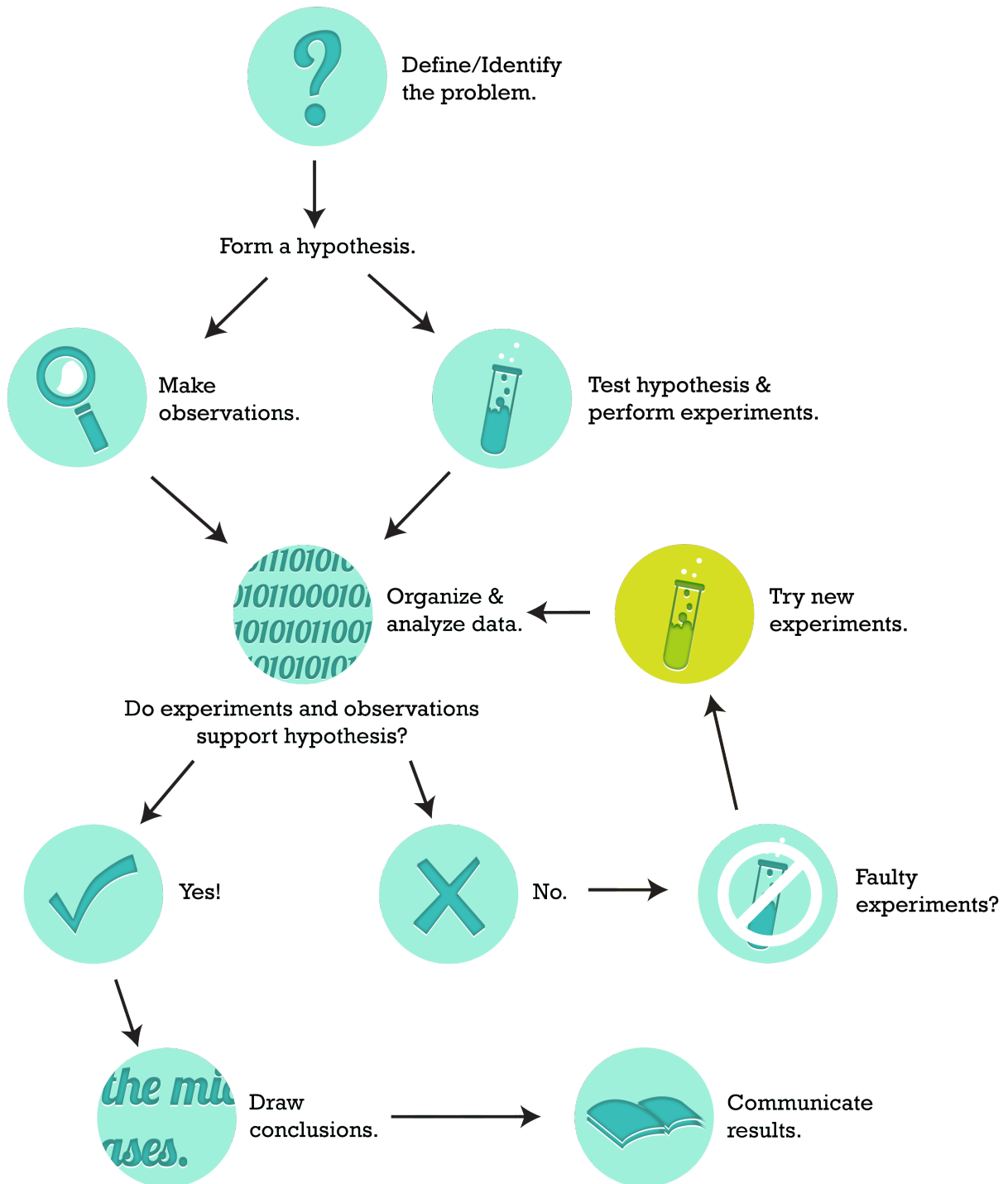
**FIGURE 2.1**

This diagram shows the steps of a scientific investigation. Other arrows could be added to the diagram. Can you think of one? (*Hint: Sometimes evidence that does not support one hypothesis may lead to a new hypothesis to investigate.*)

**FIGURE 2.2**

Each end of this bracelet contains a small magnet. The magnets attract each other and hold together the two ends.

Tara is controlling for any magnet variables that might affect the results. What other variables should Tara control? (*Hint: What about the paper clips?*)

Doing Other Types of Studies

Not everything in physical science is as easy to study as magnets and paper clips. Sometimes it's not possible or desirable to do experiments. There are some things with which a person simply cannot experiment. A distant star is a good example. Scientists study stars by making observations with telescopes and other devices. Often, it's important to investigate a problem in the real world instead of in a lab. Scientists do **field studies** to gather real-world evidence. You can see an example of a field study in **Figure 2.3**.

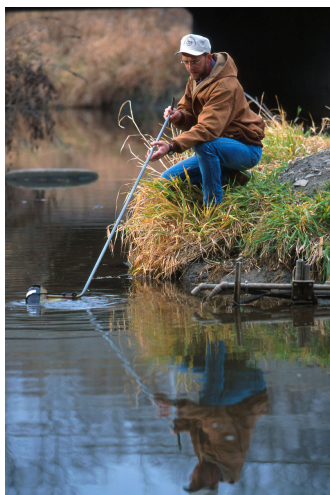
**FIGURE 2.3**

This scientist is investigating the effects farming practices have on the water quality. He is collecting and analyzing samples of river water. How might the evidence he gathers in the field help him solve the problem?

Communicating Results

Researchers should always communicate their results. By sharing their results, they may be able to get helpful feedback from other scientists. Reporting on research also lets other scientists repeat the investigation to see whether they get the same results. Getting the same results when an experiment is repeated is called **replication**. If results can be replicated, it means they are more likely to be correct. Replication of investigations is one way that a hypothesis may eventually become a theory.

Scientists can share their results in various ways. For example, they can write articles for peer-reviewed science journals. Peer review means that the work is analyzed by peers, in this case other scientists. This is the best way to ensure that the results are accurate and reported honestly. Another way to share results with other scientists is with presentations at scientific meetings (see **Figure 2.4**). Creating websites and writing articles for newspapers and magazines are ways to share research with the public. Why might this be important?

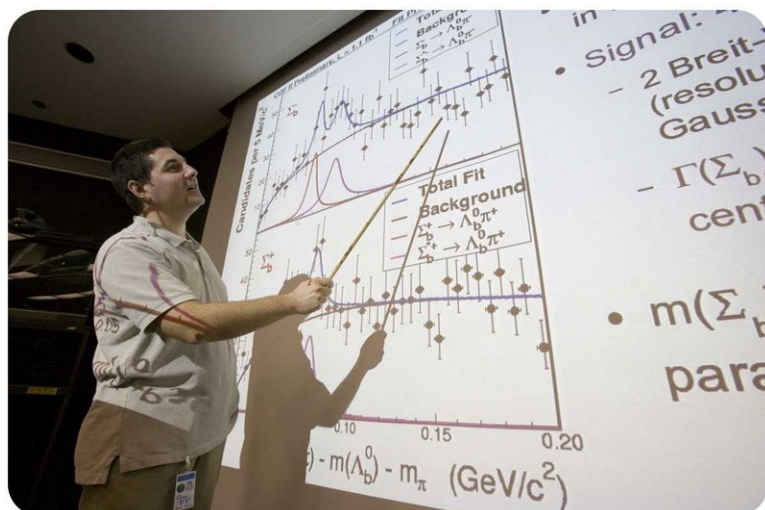

FIGURE 2.4

This researcher is presenting his results to a group of other scientists in his field.

Ethics and Scientific Research

Ethics refers to rules for deciding between right and wrong. Ethics is an important issue in science. Scientific research must be guided by ethical rules, including those listed below. The rules help ensure that the research is done safely and the results are reliable. Following the rules furthers both science and society. You can learn more about the role of ethics in science by following the links at this URL: <http://www.files.chem.vt.edu/chem-ed/ethics/index.html#resources> .

Ethical Rules for Scientific Research

- Scientific research must be reported honestly. It is wrong and misleading to make up or change research results.
- Scientific researchers must try to see things as they really are. They should avoid being biased by the results they expect or want to get.
- Researchers must be careful. They should take pains to avoid errors in their data.
- Researchers studying human subjects must tell their subjects about any potential risks of the research. Subjects also must be told that they can refuse to participate in the research.
- Researchers must inform coworkers, students, and members of the community about any risks of the research. They should proceed with the research only if they have the consent of these groups.
- Researchers studying living animals must treat them humanely. They should provide for their needs and do what they can to avoid harming them (see **Figure 2.5**).

Sometimes, science can help people make ethical decisions in their own lives, although science is unlikely to be the only factor involved. For example, scientific evidence shows that human actions are affecting Earth's climate. Actions such as driving cars are causing Earth to get warmer. Does this mean that it is unethical to drive a car to work or school? What if driving is the only way to get there? As this example shows, ethical decisions are likely to be influenced by many factors, not just science. Can you think of other factors that might affect ethical decisions such as this one?

**FIGURE 2.5**

This scientist is studying lab rats. He keeps them in comfortable cages and provides them with plenty of food and water.

Lesson Summary

- Steps of a scientific investigation include identifying a research question or problem, forming a hypothesis, gathering evidence, analyzing evidence, deciding whether the evidence supports the hypothesis, drawing conclusions, and communicating the results.
- Scientific research must be guided by ethical rules. They help ensure that the research is done safely and the results are reliable.

Lesson Review Questions

Recall

1. List the steps of a typical scientific investigation.
2. State why communication is important in scientific research.
3. Identify three ethical rules for scientific research.

Apply Concepts

4. Write a hypothesis based on this question: Do vinegar and water freeze at the same temperature? Make a prediction based on your hypothesis.
5. Describe an experiment you could do to test your prediction in question 4. Identify the variables and controls in your experiment. Include a list of materials. With your teacher's approval, conduct your investigation.

Think Critically

6. In Tara's experiment with the magnet, she measured and recorded the data in the **Table 2.1**.

TABLE 2.1: Tara's Data Table

Magnet Temperature (°C)	Number of Paper Clips Picked up by Magnet
24	8
4	6
3	6

Based on these data, Tara wrote this conclusion:

Magnets get stronger at cooler temperatures, but only down to 4°C. Below 4°C, the strength of magnets does not change.

Do you agree with Tara's conclusion? Why or why not? Suggest an alternative explanation for the data.

7. Describe a better experiment to test Tara's original hypothesis. (*Hint: You might include more measurements, a wider range of temperatures, and more than one magnet.*)

Points to Consider

Scientific investigations often involve measuring. For example, Tara measured the temperature of a magnet with a thermometer. Thermometers may have different scales. You may be most familiar with the Fahrenheit and Celsius scales.

- Do you know how the Fahrenheit and Celsius scales differ? For example, what are the freezing and boiling points of water on each scale?
- Do you know how to convert a temperature from one scale to the other?

2.2 Science Skills

Lesson Objectives

- Explain how measurements are made in scientific research.
- Describe how to keep good records in scientific investigations.
- Demonstrate how to use significant figures and scientific notation.
- Calculate descriptive statistics and use data graphs.
- Identify the role of models in science.
- Describe how to stay safe when doing scientific research.

Lesson Vocabulary

- accuracy
- Kelvin scale
- mean
- model
- precision
- range
- scientific notation
- SI
- significant figures

Introduction

Measuring is an important science skill. Other skills needed to do science include keeping records, doing calculations, organizing data, and making models. Knowing how to stay safe while doing scientific investigations may be the most important skill of all. You will read about all these science skills in this lesson.

Measuring

One of the most important aspects of measuring is the system of units used for measurement. Remember the Mars Climate Orbiter that opened this chapter? It shows clearly why a single system of measurement units is needed in science.

Using SI Units

The measurement system used by most scientists is the International System of Units, or **SI**. **Table 2.2** lists common units in this system. SI is easy to use because everything is based on the number 10. Basic units are multiplied or divided by powers of ten to arrive at bigger or smaller units. Prefixes are added to the names of the basic units to indicate the powers of ten. For example, the meter is the basic unit of length. The prefix *kilo-* means 1000, so a kilometer is 1000 meters. Can you infer what the other prefixes in the table mean? If not, you can find out at this URL: <http://physics.nist.gov/cuu/Units/prefixes.html> .

TABLE 2.2: Common SI Units

Variable	Basic SI Unit (English Equivalent)	Related SI Units	Equivalent Units
Length	meter (m) (1 m = 39.37 in)	kilometer (km) decimeter (dm) centimeter (cm) millimeter (mm) micrometer (μm) nanometer (nm)	= 1000 m = 0.1 m = 0.01 m = 0.001 m = 0.000001 m = 0.000000001 m
Volume	cubic meter (m^3) (1 m^3 = 1.3 yd^3)	liter (L) milliliter (mL)	= 1 dm^3 = 1 cm^3
Mass	gram (g) (1 g = 0.04 oz)	kilogram (kg) milligram (mg)	= 1000 g = 0.001 g

The SI system has units for other variables in addition to the three shown here in **Table 2.2**. Some of these other units are introduced in later chapters.

Problem Solving

Problem: Use information in **Table 2.2** to convert 3 meters to inches.

Solution: $3 \text{ m} = 3 \times 39.37 \text{ in} = 118.11 \text{ in}$

You Try It!

Problem: Rod needs to buy 1 m of wire for a science experiment. The wire is sold by the yard, not the meter. If he buys 1 yd of wire, will he have enough? (*Hint:* How many inches are there in 1 yd? In 1 m?)

Measuring Temperature

The SI scale for measuring temperature is the **Kelvin scale**. However, some scientists use the Celsius scale instead. If you live in the U.S., you are probably more familiar with the Fahrenheit scale. **Table 2.3** compares all three temperature scales. What is the difference between the boiling and freezing points of water on each of these scales?

TABLE 2.3: Temperature Scales

Scale	Freezing Point of Water	Boiling Point of Water
Kelvin	273 K	373 K
Celsius	0°C	100°C
Fahrenheit	32°F	212°F

Each 1-degree change on the Kelvin scale is equal to a 1-degree change on the Celsius scale. This makes it easy to convert measurements between Kelvin and Celsius. For example, to go from Celsius to Kelvin, just add 273. How

would you convert a temperature from Kelvin to Celsius?

Converting between Celsius and Fahrenheit is more complicated. The following conversion factors are used:

- Celsius \rightarrow Fahrenheit : $(^{\circ}\text{C} \times 1.8) + 32 = ^{\circ}\text{F}$
- Fahrenheit \rightarrow Celsius : $(^{\circ}\text{F} - 32) \div 1.8 = ^{\circ}\text{C}$

Problem Solving

Problem: Convert 10°C to Fahrenheit.

Solution: $(10^{\circ}\text{C} \times 1.8) + 32 = 50^{\circ}\text{F}$

You Try It!

Problem: The weather forecaster predicts a high temperature today of 86°F . What will the temperature be in Celsius?

Using Measuring Devices

Measuring devices must be used correctly to get accurate measurements. **Figure 2.6** shows the correct way to use a graduated cylinder to measure the volume of a liquid.

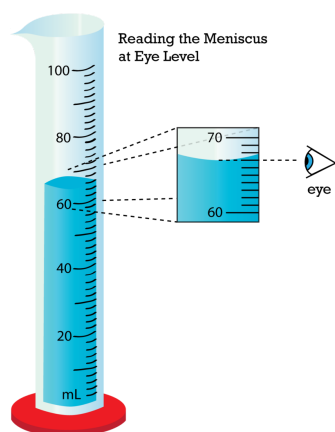

FIGURE 2.6

This cylinder contains about 66 mL of liquid. What would the measurement be if you read the top of the meniscus by mistake?

Follow these steps when using a graduated cylinder to measure liquids:

- Place the cylinder on a level surface before adding liquid.
- Move so your eyes are at the same level as the top of the liquid in the cylinder.
- Read the mark on the glass that is at the lowest point of the curved surface of the liquid. This is called the meniscus.

At the URLs below, you can see the correct way to use a metric ruler to measure length and a beam balance to measure mass.

- <http://www.wsd1.org/waec/math/Consumer%20Math%20Advanced/Unit%202%20Design%20and%20Measurement/Ruler%20Meas/measmain.htm> (metric ruler)
- <http://www.youtube.com/watch?v=C9howXG7LUY> (beam balance) (5:14)



MEDIA

Click image to the left for more content.

Accuracy and Precision

Measurements should be both accurate and precise.

- **Accuracy** is how close a measurement is to the true value. For example, 66 mL is a fairly accurate measurement of the liquid in **Figure 2.6**.
- **Precision** is how exact a measurement is. A measurement of 65.5 mL is more precise than a measurement of 66 mL. But in **Figure 2.6**, it is not as accurate.

You can think of accuracy and precision in terms of a game like darts. If you are aiming for the bull's-eye and get all of the darts close to it, you are being both accurate and precise. If you get the darts all close to each other somewhere else on the board, you are precise, but not accurate. And finally, if you get the darts spread out all over the board, you are neither accurate nor precise.

Keeping Records

Record keeping is very important in scientific investigations. Follow the tips below to keep good science records.

- Use a bound laboratory notebook so pages will not be lost. Write in ink for a permanent record.
- Record the steps of all procedures.
- Record all measurements and observations.
- Use drawings as needed.
- Date all entries, including drawings.

Calculating

Doing science often requires calculations. Converting units is just one example. Calculations are also needed to find derived quantities.

Calculating Derived Quantities

Derived quantities are quantities that are calculated from two or more different measurements. Examples include area and volume. It's easy to calculate these quantities for a simple shape. For a rectangular solid, like the one in **Figure 2.7**, the formulas are:

$$\text{Area (of each side)} = \text{length} \times \text{width} (l \times w)$$

$$\text{Volume} = \text{length} \times \text{width} \times \text{height} (l \times w \times h)$$

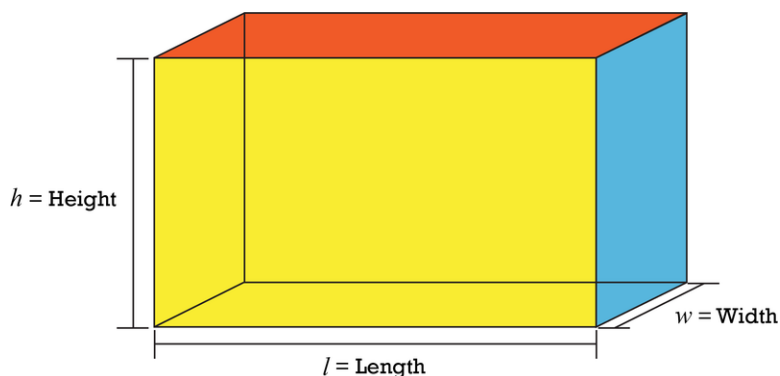

FIGURE 2.7

Dimensions of a rectangular solid include length (l), width (w), and height (h). The solid has six sides. How would you calculate the total surface area of the solid?

Helpful Hints

When calculating area and volume, make sure that:

- all the measurements have the same units.
- answers have the correct units. Area should be in squared units, such as cm^2 ; volume should be in cubed units, such as cm^3 . Can you explain why?

Naturally, not all derived quantities will have the same types of units. In the examples above, the only fundamental unit used was meters for the length of one of the sides of the box. However, if you had a quantity like speed (a derived quantity), it would be equal to distance traveled (which is meters) divided by the amount of time you spent traveling that distance (which is in seconds). Therefore your speed would be measured in meters per second.

Using Significant Figures

Assume you are finding the area of a rectangle with a length of 6.8 m and a width of 6.9 m. When you multiply the length by the width on your calculator, the answer you get is 46.92 m^2 . Is this the correct answer? No; the correct answer is 46.9 m^2 . The correct answer must be rounded down so there is just one digit to the right of the decimal point. That's because the answer cannot have more digits to the right of the decimal point than any of the original measurements. Using extra digits implies a greater degree of precision than actually exists. The correct number of digits is called the number of **significant figures**. To learn more about significant figures and rounding, you can watch the videos at the URLs below.

- <http://www.youtube.com/watch?v=ZbTxK6-1fDg> (3:20)
- <http://www.youtube.com/watch?v=Muvyoqz5lxM> (8:30)

Using Scientific Notation

Quantities in science may be very large or very small. This usually requires many zeroes to the left or right of the decimal point. Such numbers can be hard to read and write accurately. That's where scientific notation comes in. **Scientific notation** is a way of writing very large or small numbers that uses exponents. Numbers are written in this format:

$$a \times 10^b$$

The letter a stands for a decimal number. The letter b stands for an exponent, or power, of 10. For example, the number 300 is written as 3.0×10^2 . The number 0.03 is written as 3.0×10^{-2} . **Figure 2.8** explains how to convert numbers to and from scientific notation. For a review of exponents, watch: <http://www.youtube.com/watch?v=8htcZca0JIA>.

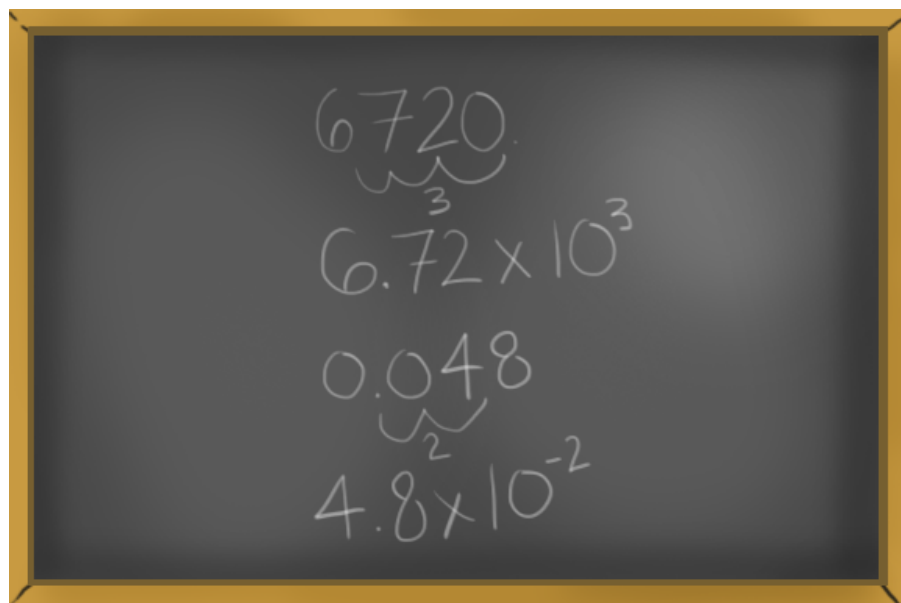

1. Move the decimal point left or right until you reach the last nonzero digit. This new decimal number is a in $a \times 10^b$.

2. Count how many places you moved the decimal point in Step 1. This number is b in $a \times 10^b$.

3. Did you move the decimal point left? If so, b is positive. Did you move the decimal point right? If so, b is negative.

FIGURE 2.8

Follow the steps in reverse to convert numbers from scientific notation.

You Try It!

Problem: Write the number 46,000,000 in scientific notation.

Organizing Data

In a scientific investigation, a researcher may make and record many measurements. These may be compiled in spreadsheets or data tables. In this form, it may be hard to see patterns or trends in the data. Descriptive statistics and graphs can help organize the data so patterns and trends are easier to spot.

Example: A vehicle checkpoint was set up on a busy street. The number of vehicles of each type that passed by the checkpoint in one hour was counted and recorded in **Table 2.4**. These are the only types of vehicles that passed the checkpoint during this period.

TABLE 2.4: Data Table

Type of Vehicle	Number
4-door cars	150
2-door cars	50
SUVs	80

TABLE 2.4: (continued)

Type of Vehicle	Number
vans	50
pick-up trucks	70

Descriptive Statistics

A descriptive statistic sums up a set of data in a single number. Examples include the mean and range.

- The **mean** is the average value. It gives you an idea of the typical measurement. The mean is calculated by summing the individual measurements and dividing the total by the number of measurements. For the data in **Table 2.4**, the mean number of vehicles by type is: $(150 + 50 + 80 + 50 + 70) \div 5 = 80$. (There are two other words people can sometimes use when they use the word "average." They might be referring to a quantity called the "median" or the "mode." You'll see these quantities in later courses, but for now, we'll just say the average is the same thing as the mean.)
- The **range** is the total spread of values. It gives you an idea of the variation in the measurements. The range is calculated by subtracting the smallest value from the largest value. For the data in **Table 2.4**, the range in numbers of vehicles by type is: $150 - 50 = 100$.

Graphs

Graphs can help you visualize a set of data. Three commonly used types of graphs are bar graphs, circle graphs, and line graphs. **Figure 2.9** shows an example of each type of graph. The bar and circle graphs are based on the data in **Table 2.4**, while the line graph is based on unrelated data. You can see more examples at this URL: <http://www.baeonlearningcenter.com/weblessons/kindsofgraphs/default.htm> .

- Bar graphs are especially useful for comparing values for different types of things. The bar graph in **Figure 2.9** shows the number of vehicles of each type that passed the checkpoint.
- Circle graphs are especially useful for showing percents of a whole. The circle graph in **Figure 2.9** shows the percent of all vehicles counted that were of each type.
- Line graphs are especially useful for showing changes over time. The line graph in **Figure 2.9** shows how distance from school changed over time when some students went on a class trip.

Helpful Hints

Circle graphs show percents of a whole. What are percents?

- Percents are fractions in which the denominator is 100. *Example:* $30\% = 30/100$
- Percents can also be expressed as decimal numbers. *Example:* $30\% = 0.30$

You Try It!

Problem: Show how to calculate the percents in the circle graph in **Figure 2.9**.

Need a refresher on percents, fractions, and decimals? Go to this URL: <http://www.mathsisfun.com/decimal-fraction-percentage.html> .

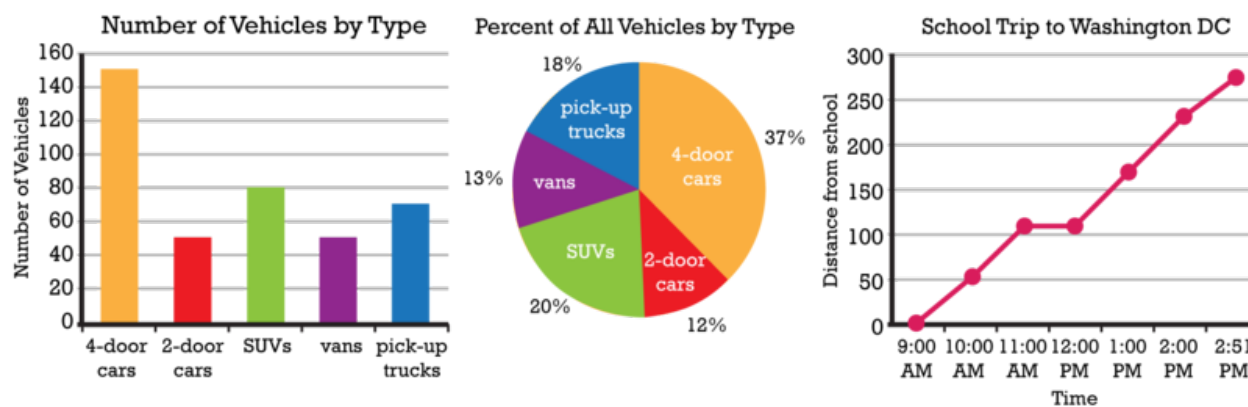
FIGURE 2.9

These are three commonly used types of graphs. When would you want to use a bar graph? What about a line graph?

Using Models

Did you ever read a road map, sketch an object, or play with toy trucks or dolls? No doubt, the answer is yes. What do all these activities have in common? They all involve models. A **model** is a representation of an object, system, or process. For example, a road map is a representation of an actual system of roads on the ground.

Models are very useful in science. They provide a way to investigate things that are too small, large, complex, or distant to investigate directly. **Figure 2.10** shows an example of a model in chemistry. To be useful, a model must closely represent the real thing in important ways, but it must be simpler and easier to manipulate than the real thing. Do you think the model in **Figure 2.10** meets these criteria?

Staying Safe in Science

Research in physical science can be exciting, but it also has potential dangers. Whether in the lab or in the field, knowing how to stay safe is important.

Safety Symbols

Lab procedures and equipment may be labeled with safety symbols. These symbols warn of specific hazards, such as flames or broken glass. Learn the symbols so you will recognize the dangers. A list of common safety symbols is shown in **Figure 2.11**. Do you know how to avoid each hazard? You can learn more at this URL: <http://www.angel-fire.com/va3/chemclass/safety.html> .

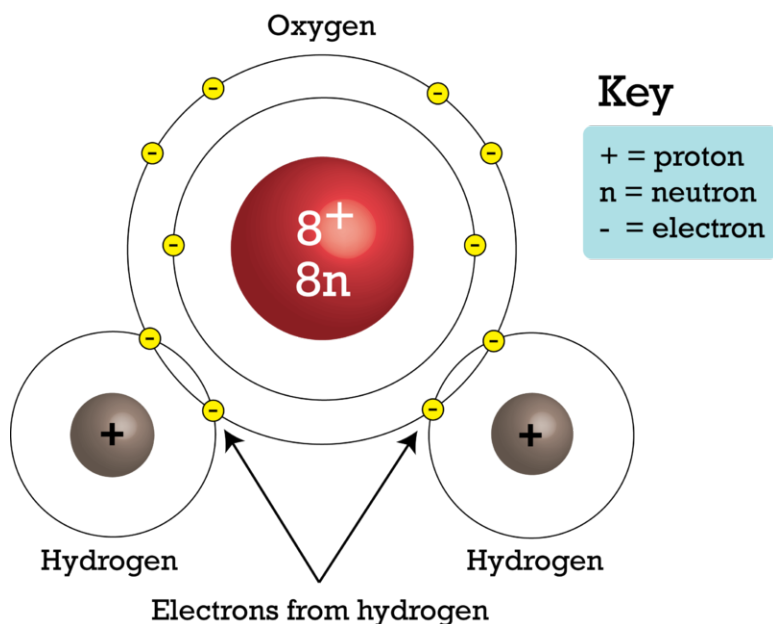

FIGURE 2.10

This model represents a water molecule. It shows that a water molecule consists of an atom of oxygen and two atoms of hydrogen. What else does the model show?



FIGURE 2.11

Why does glassware pose a hazard?

Safety Rules

Following basic safety rules is the best way to stay safe in science. Safe practices help prevent accidents. Several lab safety rules are listed below. Different rules may apply when you work in the field. But in all cases, you should always follow your teacher's instructions.

Lab Safety Rules

- Wear safety gear, including goggles, an apron, and gloves.
- Wear a long-sleeved shirt and shoes that completely cover your feet.
- Tie back your hair if it is long.
- Do not eat or drink in the lab.
- Never work alone.
- Never perform unauthorized experiments.
- Never point the open end of a test tube at yourself or another person.
- Always add acid to water —never water to acid —and add the acid slowly.
- To smell a substance, use your hand to fan vapors toward your nose rather than smell it directly. This is demonstrated in **Figure 2.12**.
- When disposing of liquids in the sink, flush them down the drain with lots of water.
- Wash glassware and counters when you finish your lab work.
- Thoroughly wash your hands with soap and water before leaving the lab.

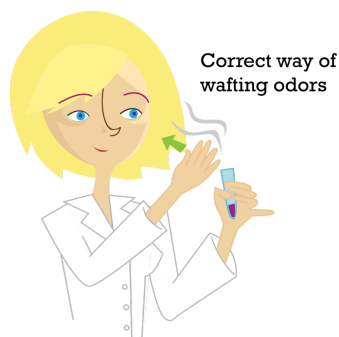
**FIGURE 2.12**

This is the correct way to smell a chemical in science lab. This helps prevent possible injury from toxic fumes.

Even when you follow the rules, accidents can happen. Immediately alert your teacher if an accident occurs. Report all accidents, even if you don't think they are serious.

Lesson Summary

- Most scientists use the SI system of units. It includes the Kelvin scale for temperature. Measurements should be both accurate and precise.
- Good record keeping is very important in scientific research.
- Doing science often requires calculations, such as finding derived quantities. Calculations may involve significant figures or scientific notation.
- Descriptive statistics and graphs help organize data so patterns and trends are more apparent. Descriptive statistics include the mean and range. Types of graphs include bar, circle, and line graphs.
- A model is a representation of an object, system, or process. Models help scientists investigate things that are too small, large, complex, or distant to study directly.
- Staying safe while doing scientific research means recognizing safety symbols and following safety rules.

Lesson Review Questions

Recall

1. What are the basic SI units for length, volume, and mass?
2. How much liquid does this graduated cylinder contain?

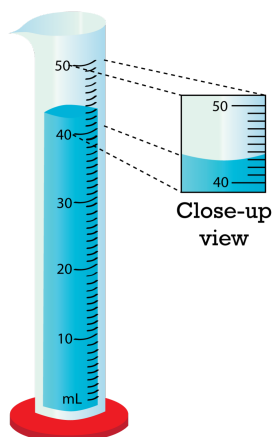

3. Define the mean and range of a data set. How are they calculated?
4. What is a model? How are models used in science?
5. What hazard does each of these symbols represent?

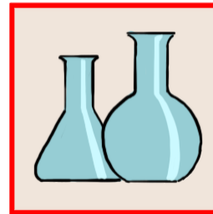

Apply Concepts

6. Do the following calculations:
 - a. Write the number 0.0000087 in scientific notation.
 - b. Convert 50°C to $^{\circ}\text{F}$.
 - c. Find the volume of a cube that measures 5 cm on each dimension (length, width, and height).
7. Make a safety poster to convey one of the lab safety rules in this lesson.

Think Critically

8. Compare and contrast accuracy and precision of measurements in science.

Points to Consider

Most of the skills described in this lesson are important in technology as well as science.

- What is technology?
- How do you think technology differs from science?

2.3 Technology

Lesson Objectives

- Define technology.
- Outline the technological design process.
- Explain how science and technology are related.
- Describe how technology and society influence each other.

Lesson Vocabulary

- engineer
- technological design
- technology

Introduction

What do you think of when you hear the word technology? Do devices like computers and solar-powered cars come to mind? Devices such as these are just one meaning of the term "technology." As a field of study, technology is much broader than that.

What Is Technology?

Technology is the application of knowledge to real-world problems. It includes methods and processes as well as devices like computers and cars. An example is the Bessemer process. It is a cheap method of making steel that was invented in the 1850s. It is just one of many technological advances that have occurred in manufacturing. Technology is also responsible for most of the major advances in agriculture, transportation, communications, and medicine. Clearly, technology has had a huge impact on people and society. It is hard to imagine what life would be like without it.

Professionals in technology are generally called **engineers**. Most engineers have a strong background in physical science. There are many different careers in engineering. You can learn about some of them at the URLs below.

- http://www.sciencebuddies.org/science-fair-projects/science_careers.shtml?gclid=CMbjl5HB4qgCFcW8Kgod7HdmGQ
- <http://www.careertools.com/engineering/>

Technological Design

The development of new technology is called **technological design**. It is similar to scientific investigation. Both processes use evidence and logic to solve problems.

Technological Design Process

Figure 2.13 shows the steps of the technological design process. Consider the problem of developing a solar-powered car. Many questions would have to be researched in the design process. For example, what is the best shape for gathering the sun's rays? How will the energy from the sun be stored? Will a back-up energy source be needed? After researching the answers, possible designs are developed. This takes imagination as well as reason. Then a model is made of the best design, and the model is tested. This allows any problems with the design to be worked out before a final design is selected.

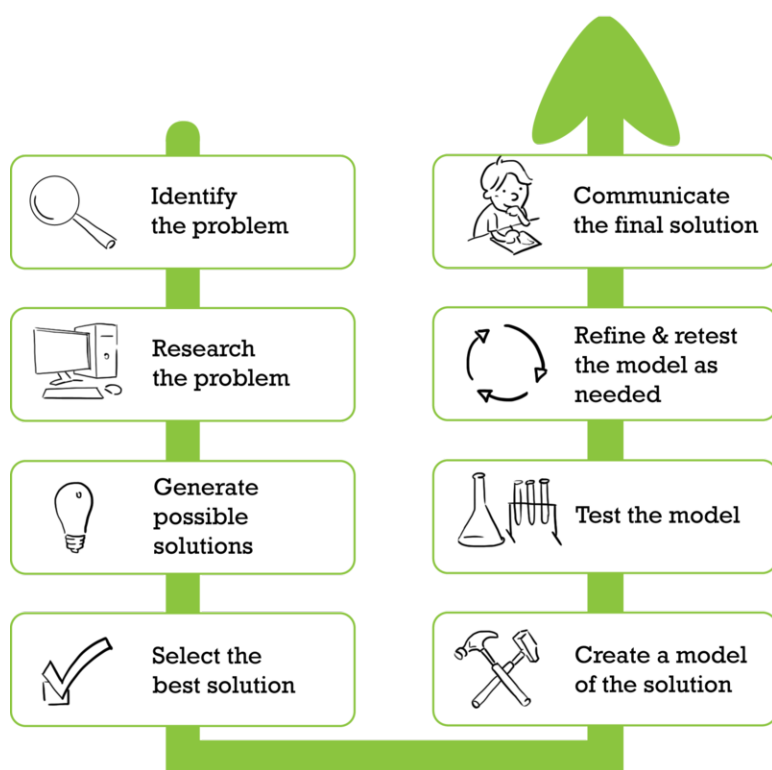

FIGURE 2.13

This flowchart represents the process of technological design. How does the technological design process resemble a scientific investigation?

Constraints on Technological Design

Technological design always has constraints. Constraints are limits on the design. Common constraints include:

- laws of nature, such as the law of gravity.
- properties of the materials used.
- cost of producing a technology.

Ethical concerns are also constraints on many technological designs. Like scientists, engineers must follow ethical rules. For example, the technologies they design must be as safe as possible for people and the environment.

Engineers must weigh the benefits and risks of new technologies, and the benefits should outweigh the risks.

Advances in Technology

Technology advances as new materials and processes are invented. Computers are a good example. **Table 2.5** and the videos below show some of the milestones in their evolution. The evolution of modern computers began in the 1930s. Computers are still evolving today. How have computers changed during your lifetime?

- <http://www.youtube.com/watch?v=ETVAIcMXitk> (4:11)



MEDIA
Click image to the left for more content.

- <http://www.youtube.com/watch?v=gas2Xi0rW6A> (5:36)



MEDIA
Click image to the left for more content.

TABLE 2.5: Evolution of Computers





Computer (Year)	Description
<p>ENIAC (1946)</p>  <p><i>US Army Photo</i></p>	<p>Like other early computers, the huge ENIAC computer used vacuum tubes for electrical signals. This made it very large and expensive. It could do just one task at a time. It had to be rewired to change programs. That's what the women in this photo are doing.</p>
<p>ERMA (1955)</p>	<p>The ERMA computer represented a new computer technology. It used transistors instead of vacuum tubes. This allowed computers to be smaller, cheaper, and more energy efficient.</p>

TABLE 2.5: (continued)

Computer (Year)	Description
<p>PDP-8 (1968)</p> 	<p>By the late 1960s, tiny transistors on silicon chips were invented. They increased the speed and efficiency of computers. They also allowed computers to be much smaller. The PDP-8 computer pictured here was the first "mini" computer.</p>
<p>Macintosh 128K (1984)</p> 	<p>The next major advance in computers was the development of microprocessors. A microprocessor consisted of thousands of integrated circuits placed on a tiny silicon chip. This allowed computers to be more powerful and even smaller. The computer pictured here is the first Macintosh personal computer.</p>
<p>MacBook Air (2010)</p> 	<p>The computers of the 21st century are tiny compared with the lumbering giants of the mid-1900s. Their problem-solving abilities are also immense compared with early computers. The diversity of software programs available today allows users to undertake an immense variety of tasks—and no rewiring is needed!</p>

Technology and Science

Technology is sometimes referred to as applied science, but it has a different goal than science. The goal of science is to increase knowledge. The goal of technology is to use knowledge for practical purposes.

Although they have different goals, technology and science work hand in hand. Each helps the other advance. Scientific knowledge is needed to create new technologies. New technologies are used to further science. The microscope is a good example. Scientific knowledge of light allowed 17th century lens makers to make the first microscopes. This new technology let scientists view a world of tiny objects they had never before seen. **Figure 2.14** describes other examples.

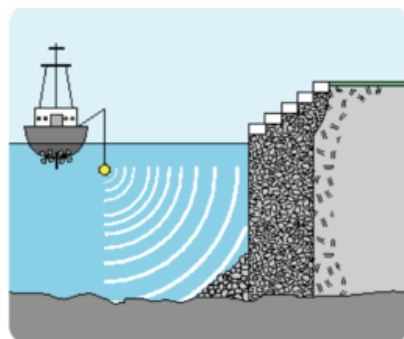
**Sonar**

What it does:
Sends sound waves and receives the sound waves that are reflected back

Based on scientific knowledge of:
Sound

Led to scientific advances such as:
Mapping of the ocean floor

**Spectrometer**

What it does:
Measures properties of light

Based on scientific knowledge of:
Light and chemical elements

Led to scientific advances such as:
Discovery of the composition and temperature of stars

The whole seismometer moves as the earth it is attached to shakes, but the heavy mass does not move because of its inertia.

The recording device measures how far the rest of the seismometer has moved with respect to the mass.

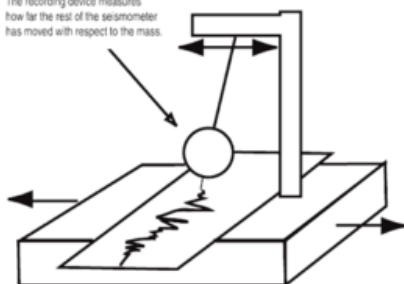
**Seismometer**

What it does:
Records ground movements caused by earthquakes

Based on scientific knowledge of:
Waves and motion

Led to scientific advances such as:
Discovery that Earth has a solid inner core

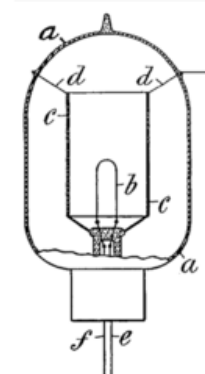

a. glass envelope
b. filament (cathode)
c. plate (anode)
d. anode lead
e, f. cathode leads

Vacuum Tube

What it does:
Creates and processes electrical signals

Based on scientific knowledge of:
Electricity and vacuums

Led to scientific advances such as:
Discovery of electrons, the negatively charged particles in atoms

FIGURE 2.14

Each of the technologies pictured here is based on scientific knowledge. Each also led to important scientific advances.

Technology and Society

The goal of technology is to solve people's problems. Therefore, the problems of society generally set the direction that technology takes. Technology, in turn, affects society. It may make people's lives easier or healthier. Two examples are described in **Figure 2.15**.

You can read about other examples at these URLs:

- <http://mezocore.wordpress.com/>
- http://www.makingthefmodernworld.org.uk/everyday_life/

Lesson Summary

- Technology is the application of knowledge to real-world problems. Engineers are professionals in technology.
- Technological design is the development of new technology. The design process is based on evidence and logic.
- Technology and science have different goals, but each helps the other advance.
- The problems of society generally set the direction of technology. New technologies, in turn, may make

Nanotechnology

Nanotechnology is the manipulation of matter at the level of atoms and molecules. In medicine, nanotechnology is used to deliver drugs to specific cells.

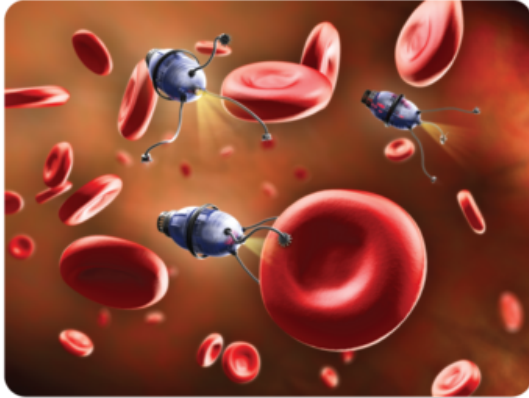
Nanoparticles in Medicine**Fiber Optics**

Fiber optics is the use of transparent fibers to transmit light. It is used in modern communications. The fibers can transmit signals long distances without loss of signal strength.

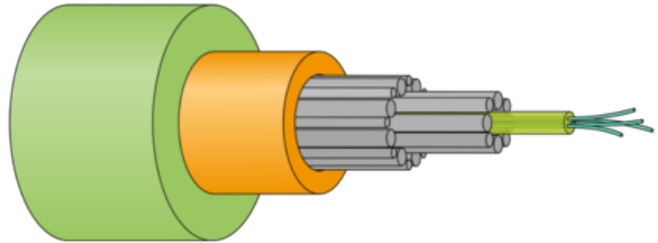
Fiber Optic Cable**FIGURE 2.15**

Technologies that help people may be as simple as forks and knives. Or they may be as complex as the two examples described here. How does technology help you?

people's lives easier or healthier.

Lesson Review Questions

Recall

1. Define technology.
2. What do engineers do?
3. List the steps of the technological design process.

Apply Concepts

4. A team of engineers is designing a new type of car. What are likely to be some of the constraints on the design?

Think Critically

5. Compare and contrast science and technology.
6. Relate technology and society.

Points to Consider

Nanotechnology manipulates atoms and molecules of matter.

- What is matter? What are its characteristics?
- Do you think all matter consists of atoms and molecules?

For **Table 2.5**, from top to bottom,

- ENIAC: Courtesy of US Army. http://commons.wikimedia.org/wiki/File:Two_women_operating_ENIAC.gif . Public Domain.
- PDP-8: User:Alkivar/Wikipedia. <http://commons.wikimedia.org/wiki/File:PDP-8.jpg> . Public Domain.
- Macintosh 128K: Blake Patterson (blakespot). <http://www.flickr.com/photos/blakespot/2388811229/> . CC BY 2.0.
- MacBook Air: Flickr: Johan Lange. <http://www.flickr.com/photos/langecom/5122950018/> . CC BY 2.0

2.4 References

1. Christopher Auyeung. [CK-12 Foundation](#) . CC BY-NC 3.0
2. Dawn Schram [deviantArt: dschram], modified by CK-12 Foundation. <http://dschram.deviantart.com/art/Spiderman-bracelet-323619648> . CC BY 3.0
3. Courtesy of Keith Weller, US Department of Agriculture. <http://www.flickr.com/photos/usdagov/8496687811/> . CC BY 2.0
4. Courtesy of Fermilab. <http://www.fnal.gov/pub/presspass/images/sigma-b-baryon-images.html> . Public Domain
5. Image copyright Ragne Kabanova, 2014. <http://www.shutterstock.com> . Used under license from Shutterstock.com
6. Christopher Auyeung. [CK-12 Foundation](#) . CC BY-NC 3.0
7. Christopher Auyeung. [CK-12 Foundation](#) . CC BY-NC 3.0
8. Laura Guerin. [CK-12 Foundation](#) . CC BY-NC 3.0
9. Christopher Auyeung. [CK-12 Foundation](#) . CC BY-NC 3.0
10. Christopher Auyeung. [CK-12 Foundation](#) . CC BY-NC 3.0
11. Laura Guerin. [CK-12 Foundation](#) . CC BY-NC 3.0
12. Christopher Auyeung. [CK-12 Foundation](#) . CC BY-NC 3.0
13. Laura Guerin and Christopher Auyeung. [CK-12 Foundation](#) . CC BY-NC 3.0
14. Sonar: Courtesy of US Geological Survey; Spectrometer: Courtesy of National Institute for Occupational Safety and Health (NIOSH); Seismometer: Courtesy of US Geological Survey; Vacuum tube: IMeowbot, based on illustration by John Ambrose Fleming. Sonar: <http://marine.usgs.gov/fact-sheets/michigan/michigan.html>; Spectrometer: http://commons.wikimedia.org/wiki/File:Microscopic_spectrometer.jpg; Seismometer: <http://earthquake.usgs.gov/learn/kids/coloring/>; Vacuum tube: <http://commons.wikimedia.org/wiki/File:Diode-tube.png> . Public Domain
15. Nanoparticles in medicine: Image copyright Andrea Danti, 2014; Fiber optics cable: Mysid. [Nanoparticles in medicine](#): <http://www.shutterstock.com>; [Fiber optics cable](#): http://commons.wikimedia.org/wiki/File:Southern_Cross_Cable_cross_section.svg . Nanoparticles in medicine: Used under license from Shutterstock.com; Fiber optics cable: Public Domain

CHAPTER

3

Introduction to Matter

Chapter Outline

- 3.1 PROPERTIES OF MATTER
- 3.2 TYPES OF MATTER
- 3.3 CHANGES IN MATTER
- 3.4 REFERENCES

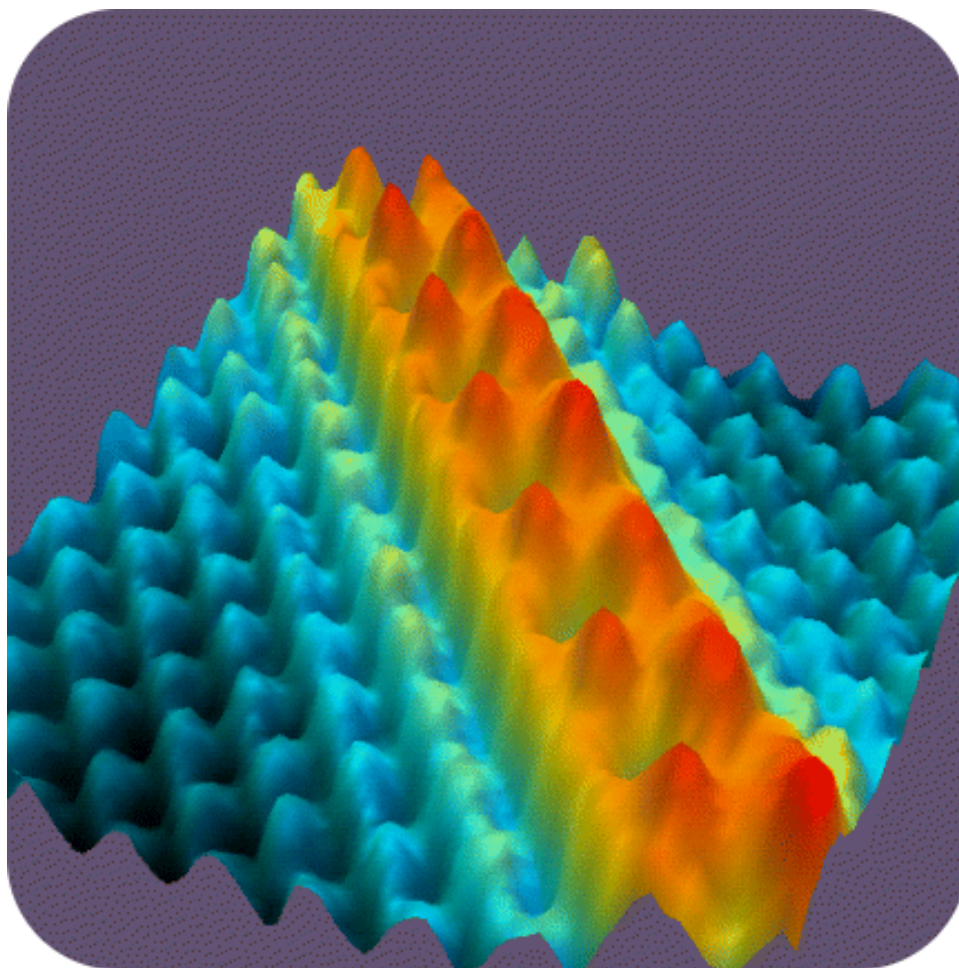

The reddish-orange peaks in this picture are individual atoms of cesium on a background of gallium arsenide (GaAs). This amazing image was made by a scanning tunneling microscope. It's the only kind of microscope that can make images of things as small as atoms. The invention of the scanning tunneling microscope was so significant that its inventors got a Nobel prize for it. Why is being able to see atoms so important? Atoms are the basic building blocks of all the matter in the universe. You will learn more about atoms and matter when you read this chapter.

Courtesy of National Institute of Standards and Technology. www.nist.gov/pml/general/stm/index.cfm. Public Domain.

3.1 Properties of Matter

Lesson Objectives

- Define matter, mass, and volume.
- Identify physical properties of matter.
- List examples of chemical properties of matter.

Vocabulary

- chemical property
- density
- flammability
- mass
- matter
- physical property
- reactivity
- volume
- weight

Introduction

Here's a riddle for you to ponder: What do you and a tiny speck of dust in outer space have in common? Think you know the answer? Read on to find out.

What is Matter?

Both you and the speck of dust consist of atoms of matter. So does the ground beneath your feet. In fact, everything you can see and touch is made of matter. The only things that aren't matter are forms of energy, such as light and sound. Although forms of energy are not matter, the air and other substances they travel through are. So what is matter? **Matter** is defined as anything that has mass and volume.

Mass

Mass is the amount of matter in a substance or object. Mass is commonly measured with a balance. A simple mechanical balance is shown in **Figure 3.1**. It allows an object to be matched with other objects of known mass. SI units for mass are the kilogram, but for smaller masses grams are often used instead.

**FIGURE 3.1**

This balance shows one way of measuring mass. When both sides of the balance are at the same level, it means that objects in the two pans have the same mass.

Mass versus Weight

The more matter an object contains, generally the more it weighs. However, weight is not the same thing as mass. **Weight** is a measure of the force of gravity pulling on an object. It is measured with a scale, like the kitchen-scale in **Figure 3.2**. The scale detects how forcefully objects in the pan are being pulled downward by the force of gravity. The SI unit for weight is the newton (N). The common English unit is the pound (lb). With Earth's gravity, a mass of 1 kg has a weight of 9.8 N (2.2 lb).

**FIGURE 3.2**

This kitchen scale measures weight. How does weight differ from mass?

Problem Solving

Problem: At Earth's gravity, what is the weight in newtons of an object with a mass of 10 kg?

Solution: At Earth's gravity, 1 kg has a weight of 9.8 N. Therefore, 10 kg has a weight of $(10 \times 9.8 \text{ N}) = 98 \text{ N}$.

You Try It!

Problem: If you have a mass of 50 kg on Earth, what is your weight in newtons?

An object with more mass is pulled by gravity with greater force, so mass and weight are closely related. However, the weight of an object can change if the force of gravity changes, even while the mass of the object remains constant. Look at the photo of astronaut Edwin E. Aldrin Jr taken by fellow astronaut Neil Armstrong, the first human to walk on the moon, in **Figure 3.3**. An astronaut weighed less on the moon than he did on Earth because the moon's gravity is weaker than Earth's. The astronaut's mass, on the other hand, did not change. He still contained the same amount of matter on the moon as he did on Earth.

The amount of space matter takes up is its **volume**. How the volume of matter is measured depends on its state.

- The volume of liquids is measured with measuring containers. In the kitchen, liquid volume is usually

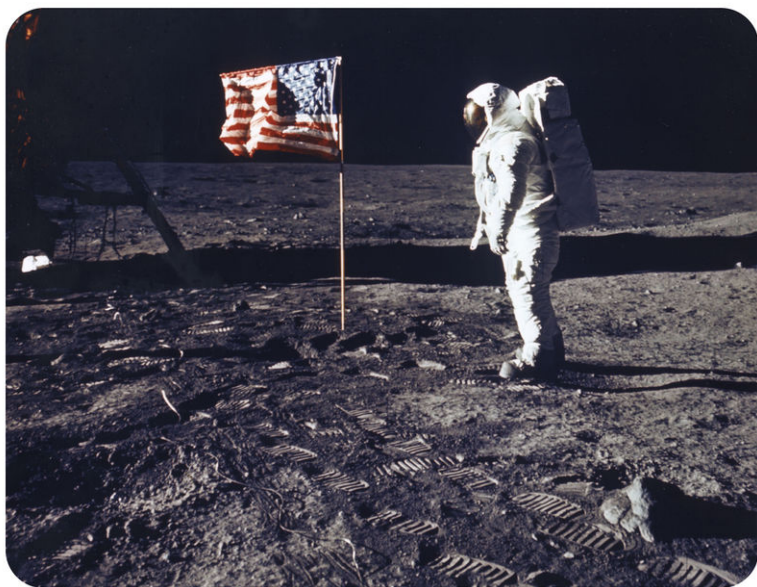
**FIGURE 3.3**

If the astronaut weighed 175 pounds on Earth, he would have weighed only 29 pounds on the moon. If his mass on Earth was 80 kg, what would his mass have been on the moon?

measured with measuring cups or spoons. In the lab, liquid volume is measured with containers such as graduated cylinders. Units in the metric system for liquid volume include liters (L) and milliliters (mL).

- The volume of gases depends on the volume of their container. That's because gases expand to fill whatever space is available to them. For example, as you drink water from a bottle, air rushes in to take the place of the water. An "empty" liter bottle actually holds a liter of air. How could you find the volume of air in an "empty" room?
- The volume of regularly shaped solids can be calculated from their dimensions. For example, the volume of a rectangular solid is the product of its length, width, and height ($l \times w \times h$). For solids that have irregular shapes, the displacement method is used to measure volume. You can see how it works in **Figure 3.4** and in the video below. The SI unit for solid volumes is cubic meters (m^3). However, cubic centimeters (cm^3) are often used for smaller volume measurements.

http://www.youtube.com/watch?v=q9L52maq_vA

Physical Properties of Matter

Matter has many properties. Some are physical properties. **Physical properties** of matter are properties that can be measured or observed without matter changing to a different substance. For example, whether a given substance normally exists as a solid, liquid, or gas is a physical property. Consider water. It is a liquid at room temperature, but if it freezes and changes to ice, it is still water. Generally, physical properties are things you can see, hear, smell, or feel with your senses.

Examples of Physical Properties

Physical properties include the state of matter and its color and odor. For example, oxygen is a colorless, odorless gas. Chlorine is a greenish gas with a strong, sharp odor. Other physical properties include hardness, freezing and boiling points, the ability to dissolve in other substances, and the ability to conduct heat or electricity. These properties are demonstrated in **Figure 3.5**. Can you think of other physical properties?

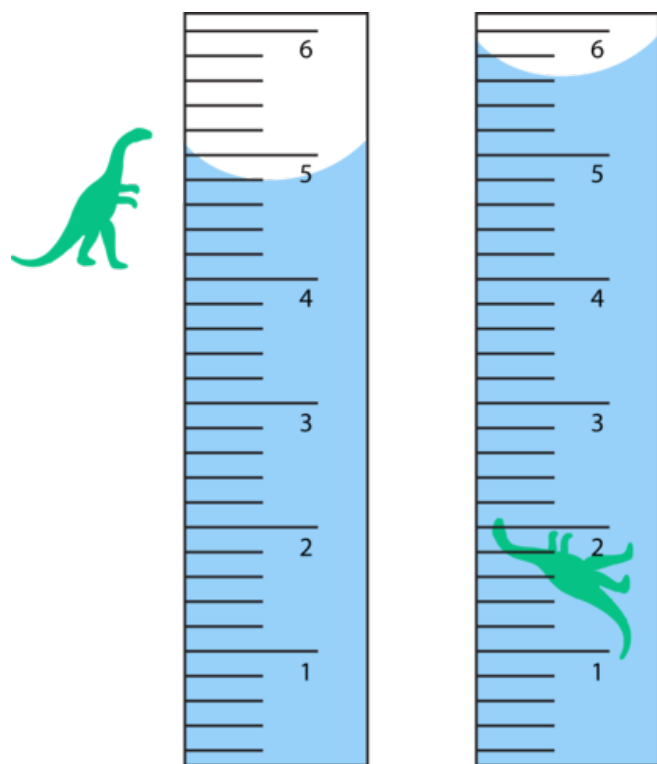

Displacement Method for Finding Volume

1. Add water to a measuring container such as a graduated cylinder. Record the volume of the water.
2. Place the object in the water in the graduated cylinder. Measure the volume of the water with the object in it.
3. Subtract the first volume from the second volume. The difference represents the volume of the object.

FIGURE 3.4

The displacement method is used to find the volume of an irregularly shaped solid object. It measures the amount of water that the object displaces, or moves out of the way. What is the volume of the toy dinosaur in mL?

Density

Density is an important physical property of matter. It reflects how closely packed the particles of matter are. Density is calculated from the amount of mass in a given volume of matter, using the formula:

$$\text{Density } (D) = \frac{\text{Mass } (M)}{\text{Volume } (V)}$$

Problem Solving

Problem: What is the density of a substance that has a mass of 20 g and a volume of 10 mL?

Solution: $D = 20 \text{ g}/10 \text{ mL} = 2.0 \text{ g/mL}$

You Try It!

Problem: An object has a mass of 180 kg and a volume of 90 m^3 . What is its density?

To better understand density, think about a bowling ball and a volleyball. The bowling ball feels heavy. It is solid all the way through. It contains a lot of tightly packed particles of matter. In contrast, the volleyball feels light. It is full of air. It contains fewer, more widely spaced particles of matter. Both balls have about the same volume, but the bowling ball has a much greater mass. Its matter is denser.



FIGURE 3.5

These are just a few of the physical properties of matter.

Chemical Properties of Matter

Some properties of matter can be measured or observed only when matter undergoes a change to become an entirely different substance. These properties are called **chemical properties**. They include flammability and reactivity.

Flammability

Flammability is the ability of matter to burn. Wood is flammable; iron is not. When wood burns, it changes to ashes, carbon dioxide, water vapor, and other gases. After burning, it is no longer wood.

Reactivity

Reactivity is the ability of matter to combine chemically with other substances. For example, iron is highly reactive with oxygen. When it combines with oxygen, it forms the reddish powder called rust (see **Figure 3.6**). Rust is not iron but an entirely different substance that consists of both iron and oxygen.

**FIGURE 3.6**

The iron in these steel chains has started to rust.

Lesson Summary

- Matter is anything that has mass and volume. Mass is the amount of matter in a substance. Volume is the amount of space matter takes up.
- Matter has both physical and chemical properties. Physical properties can be measured or observed without matter changing to a different substance.
- Chemical properties of matter can be measured or observed only when matter undergoes a change to become an entirely different substance.

Lesson Review Questions

Recall

1. Define matter.
2. How does mass differ from weight?
3. Describe the displacement method for measuring the volume of an object.
4. Identify two physical properties and two chemical properties of matter.

Apply Concepts

5. Create a table comparing and contrasting physical properties of tap water and table salt.
6. Apply the concept of density to explain why oil floats on water.

Think Critically

7. Some kinds of matter are attracted to a magnet. Is this a physical or chemical property of matter? How do you know?

Points to Consider

The physical and chemical properties of substances can be used to identify them. That's because different kinds of matter have different properties.

- What property could you use to tell the difference between iron and aluminum?

- How could you tell whether a liquid is honey or vinegar?

3.2 Types of Matter

Lesson Objectives

- Describe elements and atoms.
- Describe compounds, molecules, and crystals.
- Define mixture, and identify types of mixtures.

Vocabulary

- atom
- colloid
- compound
- crystal
- element
- mixture
- molecule
- solution
- suspension

Introduction

The properties of matter, both physical and chemical, depend on the substances that matter is made of. Matter can exist either as a pure substance or as a combination of different substances.

Elements

An **element** is a pure substance. It cannot be separated into any other substances. There are more than 90 different elements that occur in nature. Some are much more common than others. Hydrogen is the most common element in the universe. Oxygen is the most common element in Earth's crust. **Figure 3.7** shows other examples of elements. Still others are described in the video below.

<http://www.youtube.com/watch?v=d0zION8xjbM> (3:47)

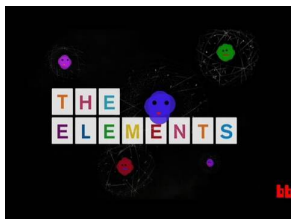

MEDIA

Click image to the left for more content.

**Helium**

Helium is a gas that is lighter than air. That's why it is used in balloons.

**Carbon**

Carbon has the ability to combine with many other elements as well as with itself. It can form many different substances. It is the most common element in living things.

**Neon**

Neon is a gas that gives off a reddish orange glow when electricity flows through it. It is used in colored lights and signs.

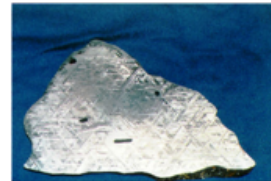
**Iron**

Iron is a metal that is very hard and strong. It is the main component of steel.

FIGURE 3.7

Each of the elements described here has different uses because of its properties.

Properties of Elements

Each element has a unique set of properties that make it different from all other elements. As a result, elements can be identified by their properties. For example, the elements iron and nickel are both metals that are good conductors of heat and electricity. However, iron is attracted by a magnet, whereas nickel is not. How could you use this property to separate iron objects from nickel objects?

History of Elements

The idea of elements is not new. It dates back about 2500 years to ancient Greece. The ancient Greek philosopher Aristotle thought that all matter consists of just four elements. He identified the elements as earth, air, water, and fire. He thought that different kinds of matter contain only these four elements but in different combinations.

Aristotle's ideas about elements were accepted for the next 2000 years. Then, scientists started discovering the many unique substances we call elements today. You can read when and how each of the elements was discovered at the link below. Scientists soon realized that there are far more than just four elements. Eventually, they discovered a total of 92 naturally occurring elements. <http://www.nndc.bnl.gov/content/origindc.pdf>

Elements and Atoms

The smallest particle of an element that still has the element's properties is an **atom**. All the atoms of an element are alike, and they are different from the atoms of all other elements. For example, atoms of gold are the same whether they are found in a gold nugget or a gold ring (see **Figure 3.8**). All gold atoms have the same structure and properties.



Gold nugget



Gold ring

FIGURE 3.8

Gold is gold no matter where it is found because all gold atoms are alike.

Compounds

There are millions of different substances in the world. That's because elements can combine in many different ways to form new substances. In fact, most elements are found in compounds. A **compound** is a unique substance that forms when two or more elements combine chemically. An example is water, which forms when hydrogen and oxygen combine chemically. A compound always has the same components in the same proportions. It also has the same composition throughout. You can learn more about compounds and how they form by watching this video: <http://www.youtube.com/watch?v=-HjMoTthEZ0> (3:53).



MEDIA

Click image to the left for more content.

Properties of Compounds

A compound has different properties than the substances it contains. For example, hydrogen and oxygen are gases at room temperature. But when they combine chemically, they form liquid water. Another example is table salt, or sodium chloride. It contains sodium and chlorine. Sodium is a silvery solid that reacts explosively with water, and chlorine is a poisonous gas (see **Figure 3.9**). But together, sodium and chlorine form a harmless, unreactive compound that you can safely sprinkle on food.

**FIGURE 3.9**

Table salt is much different than its components. What are some of its properties?

Molecules and Crystals

The smallest particle of a compound that still has the compound's properties is a **molecule**. A molecule consists of two or more atoms that are joined together. For example, a molecule of water consists of two hydrogen atoms joined to one oxygen atom (see **Figure 3.10**). You can learn more about molecules at this link: <http://www.nyhallsci.org/marvelousmolecules/marveloussub.html> .

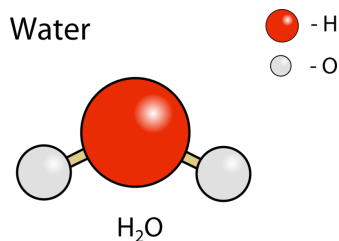
**FIGURE 3.10**

Water is a compound that forms molecules. Each water molecule consists of two atoms of hydrogen (white) and one atom of oxygen (red).

Some compounds form crystals instead of molecules. A **crystal** is a rigid, lattice-like framework of many atoms bonded together. Table salt is an example of a compound that forms crystals (see **Figure 3.11**). Its crystals are made up of many sodium and chloride ions. Ions are electrically charged forms of atoms. You can actually watch crystals forming in this video: <http://www.youtube.com/watch?v=Jd9C40Svt5g> .

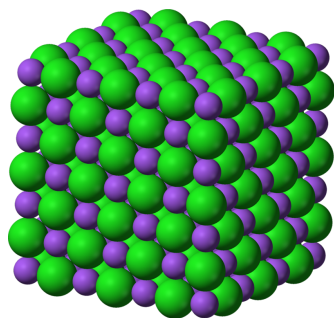
**FIGURE 3.11**

A crystal of table salt has a regular, repeating pattern of ions.

Mixtures

Not all combined substances are compounds. Some are mixtures. A **mixture** is a combination of two or more substances in any proportion. The substances in a mixture may be elements or compounds. The substances don't combine chemically to form a new substance, as they do in a compound. Instead, they keep their original properties and just intermix. Examples of mixtures include salt and water in the ocean and gases in the atmosphere. Other examples are pictured in **Figure 3.12**.



This lemonade is mixture of water, lemon juice, and sugar.



This rock is a mixture of smaller rocks and minerals.



This salad dressing is a mixture of olive oil, vinegar, herbs, and spices.



This package contains a mixture of seeds of several types of wildflowers.

FIGURE 3.12

All these substances are mixtures. How do they differ from compounds?

Homogeneous and Heterogeneous Mixtures

Some mixtures are homogeneous. This means they have the same composition throughout. An example is salt water in the ocean. Ocean water everywhere is about 3.5 percent salt.

Some mixtures are heterogeneous. This means they vary in their composition. An example is trail mix. No two samples of trail mix, even from the same package, are likely to be exactly the same. One sample might have more raisins, another might have more nuts.

Particle Size in Mixtures

Mixtures have different properties depending on the size of their particles. Three types of mixtures based on particle size are described below. **Figure 3.13** shows examples of each type. You can watch videos about the three types of mixtures at these links:

<http://www.youtube.com/watch?v=q96ljVMHYLo> (4:35)



MEDIA

Click image to the left for more content.

<http://www.youtube.com/watch?v=96OOIL6atXs> (6:13)

Distinguishing Between Solutions and Mechanical Mixtures		
	Solutions	Mechanical Mixtures
Are the parts evenly mixed?	YES	NO
Can you see the separate parts (w/liter)?	NO	YES
Do particles fall to the bottom?	NO	YES
Can you see clearly through this mixture?	YES	

MEDIA

Click image to the left for more content.

- A **solution** is a homogeneous mixture with tiny particles. An example is salt water. The particles of a solution are too small to reflect light. As a result, you cannot see them. That's why salt water looks the same as pure water. The particles of solutions are also too small to settle or be filtered out of the mixture.
- A **suspension** is a heterogeneous mixture with large particles. An example is muddy water. The particles of a suspension are big enough to reflect light, so you can see them. They are also big enough to settle or be filtered out. Anything that you have to shake before using, such as salad dressing, is usually a suspension.
- A **colloid** is a homogeneous mixture with medium-sized particles. Examples include homogenized milk and gelatin. The particles of a colloid are large enough to reflect light, so you can see them. But they are too small to settle or filter out of the mixture.



FIGURE 3.13

These three mixtures differ in the size of their particles. Which mixture has the largest particles? Which has the smallest particles?

Separating Mixtures

The components of a mixture keep their own identity when they combine. Therefore, they usually can be easily separated again. Their different physical properties are used to separate them. For example, oil is less dense than

water, so a mixture of oil and water can be separated by letting it stand until the oil floats to the top. Other ways of separating mixtures are shown in **Figure 3.14** and in the videos below.

- http://www.youtube.com/watch?v=jWdu_RVy5_A (2:30)



MEDIA

Click image to the left for more content.

- <http://www.youtube.com/watch?v=UsouAIL-YZU> (2:41)



MEDIA

Click image to the left for more content.



The sun heats salt water in this lake. This causes some of the water to evaporate, leaving the salt behind.



A coffee filter lets water but not coffee grounds pass through into the pot below.

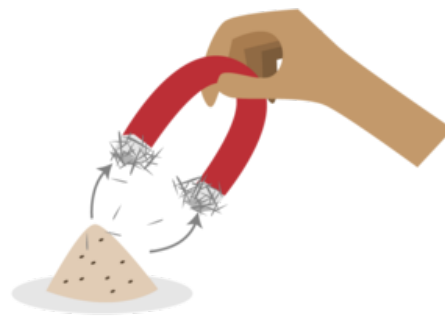

A magnet can be used to separate iron filings from sand. Can you explain why?

FIGURE 3.14

Separating the components of a mixture depends on their physical properties. Which physical property is used in each example shown here?

Lesson Summary

- Elements are pure substances with unique properties. There are more than 100 different elements (92 of which occur naturally). The smallest particles of elements are atoms.
- Compounds are unique substances that form when two or more elements combine chemically. The smallest particles of compounds are molecules. Some compounds form crystals instead.

Lesson Review Questions

Recall

1. What is an element? Give three examples.
2. Describe compounds.
3. Identify molecules and crystals.
4. What are mixtures?

Apply Concepts

5. How could you use water and a coffee filter to separate a mixture of salt and sand?
6. Homogenized milk is a colloid. It has been treated to prevent its different components from separating when it stands. When non-homogenized milk stands, the cream rises to the top because it is less dense than the rest of the milk. Which type of mixture is non-homogenized milk? Explain your answer.

Think Critically

7. Create a table comparing and contrasting compounds and mixtures. Include an example of each.
8. How are atoms related to molecules?

Points to Consider

The properties of matter are not fixed. In fact, matter is always changing.

- What are some ways you have seen matter change?
- What do you think caused the changes?

3.3 Changes in Matter

Lesson Objectives

- Define and give examples of physical changes in matter.
- Define and give examples of chemical changes in matter.
- State the law of conservation of mass.

Vocabulary

- chemical change
- law of conservation of mass
- physical change

Introduction

You hit a baseball out of the park and head for first base. You're excited. The score is tied, and now your team has a chance of getting a winning home run. Then you hear a crash. Oh no! The baseball hit a window in a neighboring house. The glass has a big hole in it, surrounded by a web of cracks (see **Figure 3.15**). The glass has changed. It's been broken into jagged pieces. But the glass is still glass. Breaking the window is an example of a physical change in matter.



FIGURE 3.15

When glass breaks, its physical properties change. Instead of one solid sheet of glass, it now has holes and cracks.

Physical Changes in Matter

A **physical change** in matter is a change in one or more of matter's physical properties. Glass breaking is just one example of a physical change. Some other examples are shown in **Figure 3.16** and in the video below. In each example, matter may look different after the change occurs, but it's still the same substance with the same chemical properties. For example, smaller pieces of wood have the ability to burn just as larger logs do.

Cutting a log into smaller pieces changes its size and shape, but it's still wood.



Braiding hair changes how the strands are arranged but not their other properties.



Crushing a metal can changes its shape. But the crushed can is still made of metal and has the same properties, such as the ability to conduct heat.



Crisp squares of chocolate melt into a shapeless puddle in the heat. The puddle tastes yummy because it's still chocolate.



Wind-blown sand has worn away this rock to create an arch, but the rock's composition has not changed. The bits of rock worn away by the wind still contain the same minerals as they did when they were part of the large rock.

FIGURE 3.16

In each of these changes, only the physical properties of matter change. The chemical properties remain the same.

<http://www.youtube.com/watch?v=Cne9ncSaN5c> (1:53)



MEDIA

Click image to the left for more content.

Because the type of matter remains the same with physical changes, the changes are often easy to undo. For example, braided hair can be unbraided again. Melted chocolate can be put in a fridge to re-harden. Dissolving salt in water is also a physical change. How do you think you could undo it?

Chemical Changes in Matter

Did you ever make a "volcano," like the one in **Figure 3.17**, using baking soda and vinegar? What happens when the two substances combine? They produce an eruption of foamy bubbles. This happens because of a chemical change. A **chemical change** occurs when matter changes chemically into an entirely different substance with different chemical properties. When vinegar and baking soda combine, they form carbon dioxide, a gas that causes the bubbles. It's the same gas that gives soft drinks their fizz.

Not all chemical changes are as dramatic as this "volcano." Some are slower and less obvious. **Figure 3.18** and the

**FIGURE 3.17**

This girl is pouring vinegar on baking soda. This causes a bubbling "volcano."

video below show other examples of chemical changes.

<http://www.youtube.com/watch?v=BqeWpywDuiY> (2:54)

**MEDIA**

Click image to the left for more content.

Signs of Chemical Change

How can you tell whether a chemical change has occurred? Often, there are clues. Several are demonstrated in **Figures 3.17** and **3.18** and in the video below.

<http://www.youtube.com/watch?v=gs0j1EZJ1Uc> (9:57)

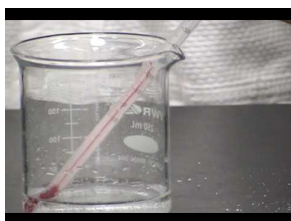
**MEDIA**

Click image to the left for more content.

To decide whether a chemical change has occurred, look for these signs:

- Gas bubbles are released. (Example: Baking soda and vinegar mix and produce bubbles.)
- Something changes color. (Example: Leaves turn from green to other colors.)
- An odor is produced. (Example: Logs burn and smell smoky.)
- A solid comes out of a solution. (Example: Eggs cook and a white solid comes out of the clear liquid part of the egg.)



FIGURE 3.18

These chemical changes all result in the formation of new substances with different chemical properties. Do you think any of these changes could be undone?

Reversing Chemical Changes

Because chemical changes produce new substances, they often cannot be undone. For example, you can't change a fried egg back to a raw egg. Some chemical changes can be reversed, but only by other chemical changes. For example, to undo the tarnish on copper pennies, you can place them in vinegar. The acid in the vinegar reacts with the tarnish. This is a chemical change that makes the pennies bright and shiny again. You can try this yourself at home to see how well it works.

Conservation of Mass

If you build a campfire, like the one in **Figure 3.19**, you start with a large stack of sticks and logs. As the fire burns, the stack slowly shrinks. By the end of the evening, all that's left is a small pile of ashes. What happened to the matter that you started with? Was it destroyed by the flames? It may seem that way, but in fact, the same amount of matter still exists. The wood changed not only to ashes but also to carbon dioxide, water vapor, and other gases. The gases floated off into the air, leaving behind just the ashes.

Assume you had measured the mass of the wood before you burned it. Assume you had also trapped the gases released by the burning wood and measured their mass and the mass of the ashes. What would you find? The ashes and gases combined have the same mass as the wood you started with.

This example illustrates the **law of conservation of mass**. The law states that matter cannot be created or destroyed. Even when matter goes through physical or chemical changes, the total mass of matter always remains the same. (In

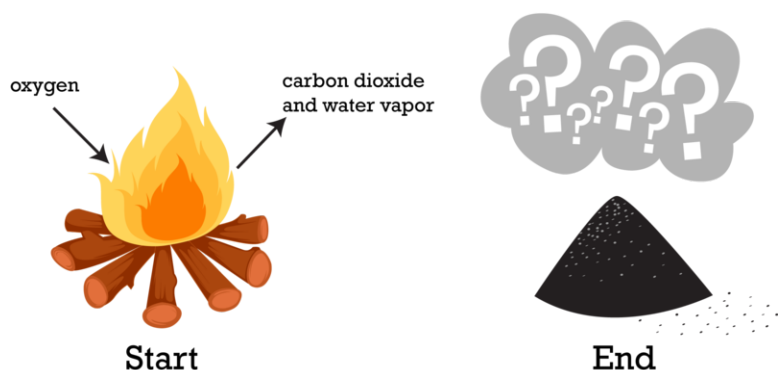
**FIGURE 3.19**

Burning is a chemical process. Is mass destroyed when wood burns?

the chapter *Nuclear Chemistry*, you will learn about nuclear reactions, in which mass is converted into energy. But other than that, the law of conservation of mass holds.) For a fun challenge, try to apply the law of conservation of mass to a scene from a Harry Potter film at this link: <http://www.youtube.com/watch?v=3TsTOmNmkf8> .

Lesson Summary

- Physical changes are changes in the physical properties of matter but not in the makeup of matter. An example of a physical change is glass breaking.
- Chemical changes are changes in the makeup and chemical properties of matter. An example of a chemical change is wood burning.
- Matter cannot be created or destroyed even when it changes. This is the law of conservation of mass.

Lesson Review Questions

Recall

1. What is a physical change in matter?
2. What happens during a chemical change in matter?
3. State the law of conservation of mass.

Apply Concepts

4. When a plant grows, its mass increases over time. Does this mean that new matter is created? Why or why not?
5. Butter melts when you heat it in a pan on the stove. Is this a chemical change or a physical change? How can you tell?

Think Critically

6. Compare and contrast physical and chemical changes in matter. Give an example of each type of change.

Points to Consider

Some physical changes in matter are changes of state.

- What are the states of matter?
- What might cause matter to change state?

3.4 References

1. Flickr:winnifredxoxo. <http://www.flickr.com/photos/61056899@N06/5751301741/> . CC BY 2.0
2. User:Batholith/Ja.Wikipedia. http://commons.wikimedia.org/wiki/File:Kitchen_scale_20101110.jpg . Public Domain
3. Courtesy of Neil Armstrong and NASA. <http://images.ksc.nasa.gov/photos/1969/captions/AS11-40-5875.html> . Public Domain
4. Christopher Auyeung. [CK-12 Foundation](#) . CC BY-NC 3.0
5. Diamond: Steve Jurvetson; Talc: Courtesy of the US Geological Survey and the Mineral Information Institute; Antifreeze: Flickr:dno1967; Water: José Manuel Suárez; Pot: Phil and Pam Gradwell (to be) (Flickr: Phil and Pam); Wire: Scott Ehardt; Sand: Jakub Michankow; Sugar: Robert Lopez and Steven Terrebonne. **Diamond:** <http://www.flickr.com/photos/jurvetson/156830367/>; **Talc:** http://commons.wikimedia.org/wiki/File:Talc_block.jpg; **Antifreeze:** <http://commons.wikimedia.org/wiki/File:Antifreeze.jpg>; **Water:** http://commons.wikimedia.org/wiki/File:Water_drop_001.jpg; **Pot:** <http://www.flickr.com/photos/philandpam/2131629044/>; **Wire:** http://commons.wikimedia.org/wiki/File:Stranded_lamp_wire.jpg; **Sand:** <http://www.flickr.com/photos/glowform/5859259137/>; **Sugar:** [CK-12 Foundation](#) . Diamond: CC BY 2.0; Talc: Public Domain; Antifreeze: CC BY 2.0; Water: CC BY 2.0; Pot: CC BY 2.0; Wire: Public Domain; Sand: CC BY 2.0; Sugar: CC BY-NC 3.0
6. fujikumo. http://commons.wikimedia.org/wiki/File:Rusted_chain.jpg . CC BY 1.0
7. Balloon: LeAnn E. Crowe (Flickr:technicolor76); Red panda: Matthijs Koster; Neon signs: Dane A. Penland; Iron: Courtesy of NASA. **Balloon:** <http://www.flickr.com/photos/86044507@N00/3705507804/>; **Red panda:** <http://www.flickr.com/photos/matthijskoster/746427079/>; **Neon signs:** <http://www.flickr.com/photos/publicresourceorg/493866748/>; **Iron:** http://commons.wikimedia.org/wiki/File:Widmanstätten_IronMet.JPG . Balloon: CC BY 2.0; Red panda: CC BY 2.0; Neon signs: CC BY 2.0; Iron: Public Domain
8. Nugget: Eden, Janine and Jim (Flickr:edenpictures); Ring: Flickr:certified su. **Nugget:** <http://www.flickr.com/photos/edenpictures/9769105003/>; **Ring:** http://www.flickr.com/photos/certified_su/2940891731/ . CC BY 2.0
9. Sodium and Chlorine: User:Greenhorn1/Wikimedia Commons; Salt: Dubravko Sorić (Flickr: SoraZG). **Sodium:** <http://commons.wikimedia.org/wiki/File:Sodium.jpg>; **Chlorine:** <http://commons.wikimedia.org/wiki/File:Chlorine2.jpg>; **Salt:** http://commons.wikimedia.org/wiki/File:Salt_shaker_on_white_background.jpg . Sodium and Chlorine: Public Domain; Salt: CC-BY 2.0
10. User:Chrkl/Wikimedia Commons (vectorisation), Raimund Apfelbach, modified by CK-12 Foundation. <http://commons.wikimedia.org/wiki/File:Wasserstoffbr%C3%BCckenbindungen-Wasser.svg> . Public Domain
11. Ben Mills (Wikimedia: Benjah-bmm27). <http://commons.wikimedia.org/wiki/File:Sodium-chloride-3D-ionic.png> . Public Domain
12. Lemonade: Flickr:momentcaptured1; Rock: James St. John (Flickr:jsj1771); Salad dressing: Image copyright Charles Brutlag, 2013; Flower seeds: Forest Kim Starr. **Lemonade:** http://www.flickr.com/photos/pat_ossa/4991556821/; **Rock:** <http://www.flickr.com/photos/jsjgeology/8475805063/>; **Salad dressing:** <http://www.shutterstock.com>; **Flower seeds:** http://commons.wikimedia.org/wiki/File:Starr_080117-1842_Calendar_of_ficinalis.jpg . Lemonade and Rock: CC BY 2.0; Salad dressing: Used under licenses from Shutterstock.com; Flower seeds: CC BY 3.0
13. Muddy and salt water: Image copyright Alena Brozova, 2013; Gelatin: Image copyright Jan Kaliciak, 2013. <http://www.shutterstock.com> . Used under licenses from Shutterstock.com
14. Lake: User:xta11/Wikimedia Commons; Coffee filter: Robert S. Donovan; Magnet: Christopher Auyeung. **Lake:** <http://commons.wikimedia.org/wiki/File:DeadSeaIsrael3.jpg>; **Coffee filter:** <http://www.flickr.com/photos/booleansplit/7181874752/>; **Magnet:** [CK-12 Foundation](#) . Lake: Public Domain; Coffee filter: CC BY 2.0; Magnet: CC BY-NC 3.0
15. Jef Poskanzer. http://commons.wikimedia.org/wiki/File:Broken_glass.jpg . CC BY 2.0

16. Log: Alex Murphy (Flickr: APM Alex); Braiding hair: Steven Depolo; Can: James Mackintosh Photography ; Arch: Frank Kovalchek; Candy: Image copyright Anteromite, 2013. Log: <http://www.flickr.com/photos/28misguidedsouls/5128954613/>; Braiding hair: <http://www.flickr.com/photos/stevendepolo/4886397967/>; Can: <http://www.flickr.com/photos/59207552@N08/8565955392/>; Arch: <http://www.flickr.com/photos/72213316@N00/5242351183/>; Candy: <http://www.shutterstock.com> . Log, Braiding hair, Can, Arch: CC BY 2.0; Candy: Used under license from Shutterstock.com
17. davidd (Flickr:puiikibeach). <http://www.flickr.com/photos/puiikibeach/3446802774/> . CC BY 2.0
18. Leaves: Kenny Louie (Flickr:kennymatic); Eggs: Image copyright Fotografas Edgargas, 2013; Pennies: F Delventhal (Flickr:krossbow); Fire: Dawn Huczek. Leaves: <http://www.flickr.com/photos/kwl/6282684630/> ; Eggs: <http://www.shutterstock.com>; Pennies: <http://www.flickr.com/photos/krossbow/4252686414/>; Fire: <http://www.flickr.com/photos/31064702@N05/3810662879/> . Leaves: CC BY 2.0; Eggs: Used under licenses from Shutterstock.com; Pennies: CC BY 2.0; Fire: CC BY 2.0
19. Christopher Auyeung. [CK-12 Foundation](#) . CC BY-NC 3.0

CHAPTER

4

States of Matter

Chapter Outline

- 4.1 SOLIDS, LIQUIDS, GASES, AND PLASMAS
- 4.2 BEHAVIOR OF GASES
- 4.3 CHANGES OF STATE
- 4.4 REFERENCES

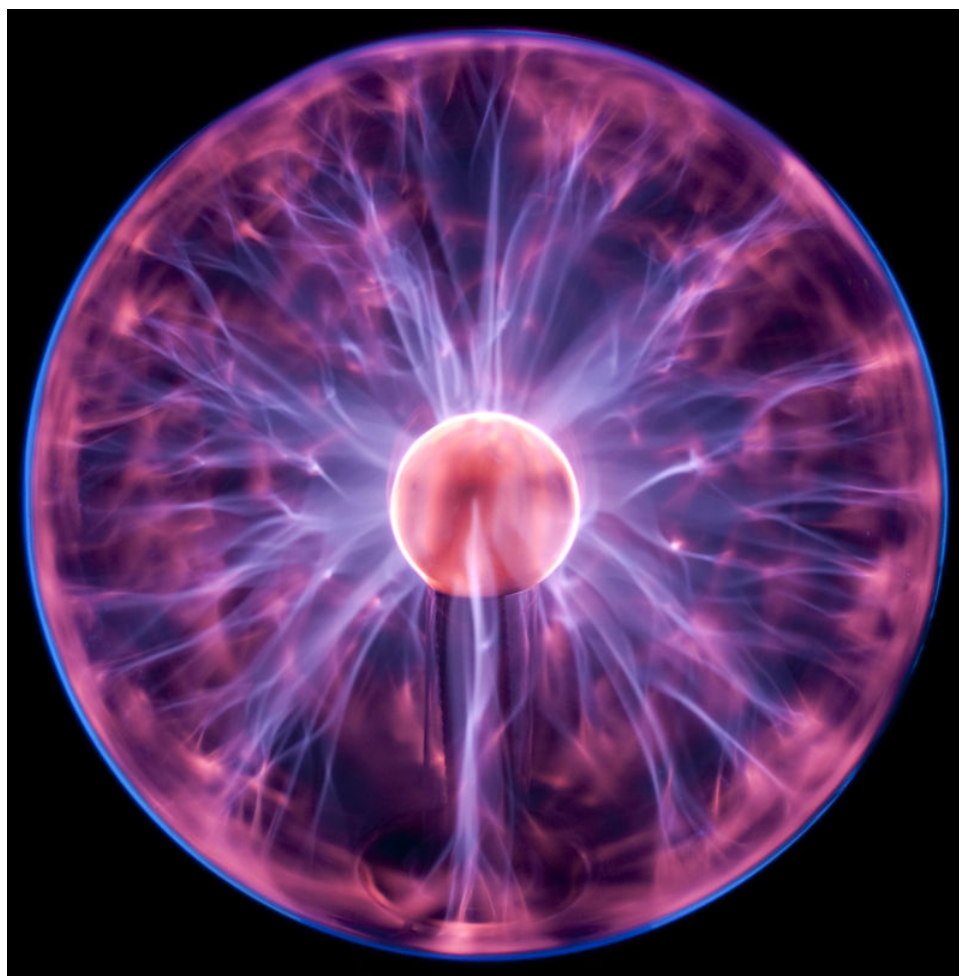

Can you guess what this picture shows? The purple and blue "flames" are matter in a particular state. You're probably familiar with the states of matter most common on Earth —solids, liquids, and gases. But these "flames" are a state of matter called plasma. This plasma ball was made by humans. Plasma also occurs in nature. In fact, plasma makes up most of the matter in the universe.

What do you know about plasma? For example, do you know where it is found in nature? In this chapter, you'll find out as you read about plasma and other states of matter.

Tony Hisgett. commons.wikimedia.org/wiki/File:Plasma_ball_%283996244124%29.jpg. CC BY 2.0.

4.1 Solids, Liquids, Gases, and Plasmas

Lesson Objectives

- Describe matter in the solid state.
- State properties of liquid matter
- Identify properties of gases.
- Describe plasma.
- Explain the relationship between energy and states of matter.

Vocabulary

- energy
- gas
- kinetic energy
- kinetic theory of matter
- liquid
- plasma
- solid
- states of matter

Introduction

States of matter are the different forms in which matter can exist. Look at **Figure 4.1**. It represents water in three states: solid (iceberg), liquid (ocean water), and gas (water vapor in the air). In all three states, water is still water. It has the same chemical makeup and the same chemical properties. That's because the state of matter is a physical property.

How do solids, liquids, and gases differ? Their properties are compared in **Figure 4.2** and described below. You can also watch videos about the three states at these URLs:

<http://www.youtube.com/watch?v=s-KvoVzukHo> (0:52)

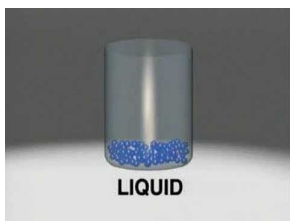

MEDIA

Click image to the left for more content.

<http://www.youtube.com/watch?v=NO90GeHgtBY> (1:42)



FIGURE 4.1

This photo represents solid, liquid, and gaseous water. Where is the gaseous water in the picture?



MEDIA

Click image to the left for more content.

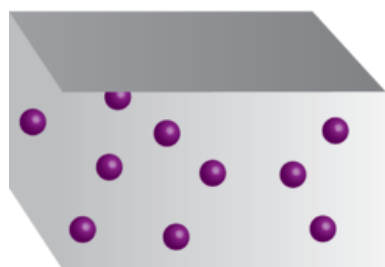

Gas

Shape of container
Volume of container



Liquid

Shape of container
Free surface
Fixed volume



Solid

Holds shape
Fixed volume

FIGURE 4.2

These three states of matter are common on Earth. What are some substances that usually exist in each of these states?

Solids

Ice is an example of solid matter. A **solid** is matter that has a fixed volume and a fixed shape. **Figure 4.3** shows examples of matter that are usually solids under Earth conditions. In the figure, salt and cellulose are examples of crystalline solids. The particles of crystalline solids are arranged in a regular repeating pattern. The steaks and candle wax are examples of amorphous ("shapeless") solids. Their particles have no definite pattern.

Salt consists of crystals of sodium and chloride.



The steaks on this grill consist of carbon compounds called proteins.

Wood is about 50 percent cellulose. Cellulose is a carbon compound



This candle consists mostly of wax, a solid fat-like substance.

FIGURE 4.3

The volume and shape of a solid can be changed, but only with outside help. How could you change the volume and shape of each of the solids in the figure without changing the solid in any other way?

Liquids

Ocean water is an example of a liquid. A **liquid** is matter that has a fixed volume but not a fixed shape. Instead, a liquid takes the shape of its container. If the volume of a liquid is less than the volume of its container, the top surface will be exposed to the air, like the oil in the bottles in **Figure 4.4**.

Two interesting properties of liquids are surface tension and viscosity.

- Surface tension is a force that pulls particles at the exposed surface of a liquid toward other liquid particles. Surface tension explains why water forms droplets, like those in **Figure 4.5**.
- Viscosity is a liquid's resistance to flowing. Thicker liquids are more viscous than thinner liquids. For example, the honey in **Figure 4.5** is more viscous than the vinegar.

You can learn more about surface tension and viscosity at these URLs:

- <http://io9.com/5668221/an-experiment-with-soap-water-pepper-and-surface-tension>

**FIGURE 4.4**

Each bottle contains the same volume of oil. How would you describe the shape of the oil in each bottle?

Rain forms large drops on the hood of a car because of surface tension.

**FIGURE 4.5**

These images illustrate surface tension and viscosity of liquids.

Honey (left) has greater viscosity than vinegar (right).



- <http://chemed.chem.wisc.edu/chempaths/GenChem-Textbook/Viscosity-840.html>
- <http://www.youtube.com/watch?v=u5AxIJSiEEs> (1:40)

**MEDIA**

Click image to the left for more content.

Gases

Water vapor is an example of a gas. A **gas** is matter that has neither a fixed volume nor a fixed shape. Instead, a gas takes both the volume and the shape of its container. It spreads out to take up all available space. You can see an

example in **Figure 4.6**.

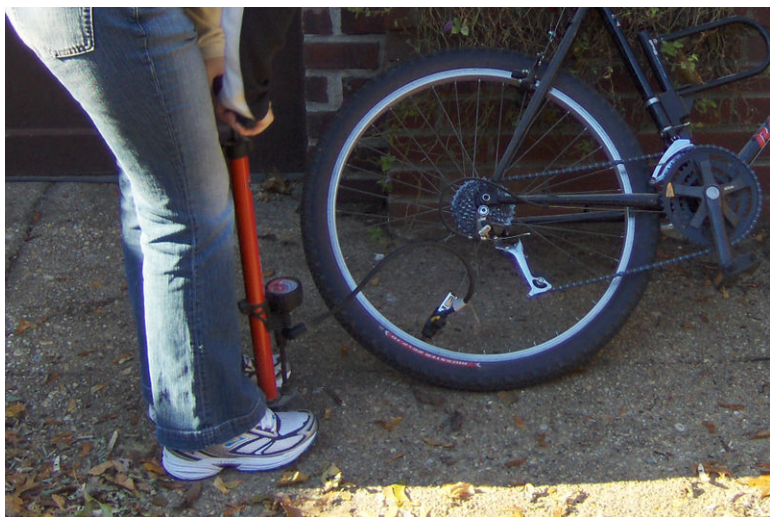

FIGURE 4.6

When you add air to a bicycle tire, you add it only through one tiny opening. But the air immediately spreads out to fill the whole tire.

Plasmas

You're probably less familiar with plasmas than with solids, liquids, and gases. Yet, most of the universe consists of plasma. **Plasma** is a state of matter that resembles a gas but has certain properties that a gas does not have. Like a gas, plasma lacks a fixed volume and shape. Unlike a gas, plasma can conduct electricity and respond to magnetism. That's because plasma contains charged particles called ions. This gives plasma other interesting properties. For example, it glows with light.

Where can you find plasmas? Two examples are shown in **Figure 4.7**. The sun and other stars consist of plasma. Plasmas are also found naturally in lightning and the polar auroras (northern and southern lights). Artificial plasmas are found in fluorescent lights, plasma TV screens, and plasma balls like the one that opened this chapter. You can learn more about plasmas at this URL: http://www.youtube.com/watch?v=VkeSI_B5Ljc (2:58).

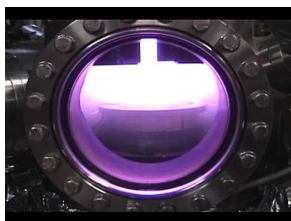

MEDIA

Click image to the left for more content.

Energy and Matter

Why do different states of matter have different properties? It's because of differences in energy at the level of atoms and molecules, the tiny particles that make up matter.



Northern Lights



Plasma TV

FIGURE 4.7

Both the northern lights (aurora borealis) and a plasma TV contain matter in the plasma state. What other plasmas are shown in the northern lights picture?

Energy

Energy is defined as the ability to cause changes in matter. You can change energy from one form to another when you lift your arm or take a step. In each case, energy is used to move matter—you. The energy of moving matter is called **kinetic energy**.

Kinetic Theory of Matter

The particles that make up matter are also constantly moving. They have kinetic energy. The theory that all matter consists of constantly moving particles is called the **kinetic theory of matter**. You can learn more about it at the URL below.

http://www.youtube.com/watch?v=Agk7_D4-deY (10:55)

Energy and States of Matter

Particles of matter of the same substance, such as the same element, are attracted to one another. The force of attraction tends to pull the particles closer together. The particles need a lot of kinetic energy to overcome the force of attraction and move apart. It's like a tug of war between opposing forces. The kinetic energy of individual particles is on one side, and the force of attraction between different particles is on the other side. The outcome of the "war" depends on the state of matter. This is illustrated in **Figure 4.8** and in the animation at this URL: <http://www.tutorvista.com/content/physics/physics-i/heat/kinetic-molecular-theory.php>.

- In solids, particles don't have enough kinetic energy to overcome the force of attraction between them. The particles are packed closely together and cannot move around. All they can do is vibrate. This explains why solids have a fixed volume and shape.
- In liquids, particles have enough kinetic energy to partly overcome the force of attraction between them. They can slide past one another but not pull completely apart. This explains why liquids can change shape but have a fixed volume.
- In gases, particles have a lot of kinetic energy. They can completely overcome the force of attraction between them and move apart. This explains why gases have neither a fixed volume nor a fixed shape.

Lesson Summary

- A solid is matter that has a fixed volume and a fixed shape.
- A liquid is matter that has a fixed volume but not a fixed shape.
- A gas is matter that has neither a fixed volume nor a fixed shape.

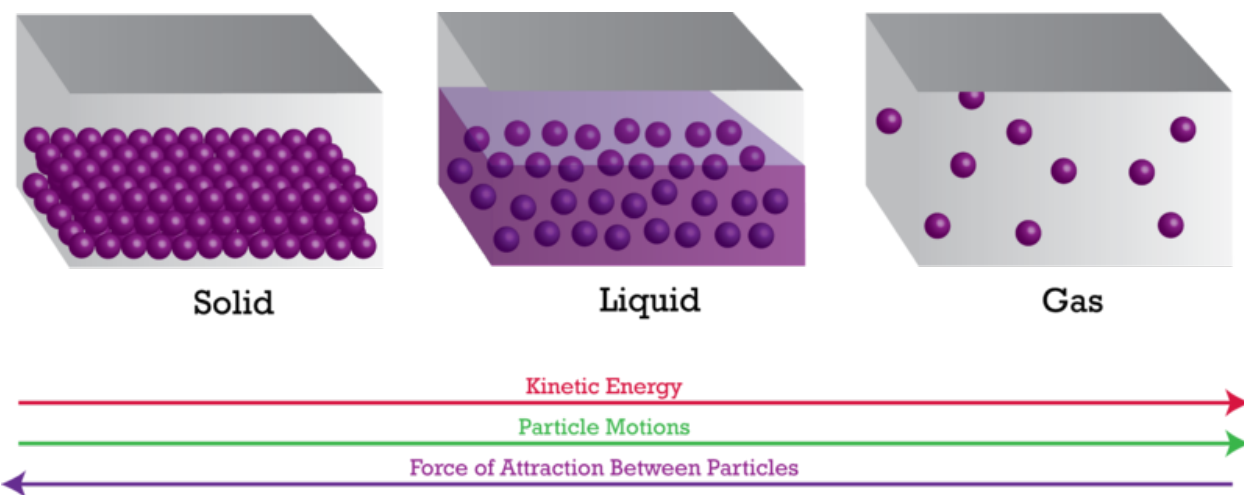
FIGURE 4.8

Kinetic energy is needed to overcome the force of attraction between particles of the same substance.

- Like a gas, plasma lacks a fixed volume and shape. Unlike a gas, it can conduct electricity and respond to magnetism.
- The state of matter depends on the kinetic energy of the particles of matter.

Lesson Review Questions

Recall

1. What are states of matter?
2. What are the properties of solids?
3. State the properties of liquids.
4. Describe properties of gases.
5. How do plasmas compare with gases?

Apply Concepts

6. Apply the concept of surface tension to explain why the surface of water in the glass shown in the **Figure 4.9** is curved upward. Why doesn't the water overflow the glass?

Think Critically

7. Explain the relationship between energy and states of matter.

**FIGURE 4.9**

The surface of water in the glass is curved upward. How does surface tension explain this phenomenon?

Points to Consider

You read in this lesson that gases expand to fill their container.

- What if gas were forced into a smaller container? Would it shrink to fit?
- What other properties of the gas might change if its particles were crowded closer together?

4.2 Behavior of Gases

Lesson Objectives

- Define pressure.
- State the gas laws.

Vocabulary

- Amonton's law
- Boyle's law
- Charles's law
- pressure

Introduction

The molecules of a gas in a closed container, such as a balloon, are not only constantly moving. They are also constantly bumping into each other and into the sides of their container. The sketch in **Figure 4.10** shows how this happens. The force of the particles against whatever they bump into creates pressure.

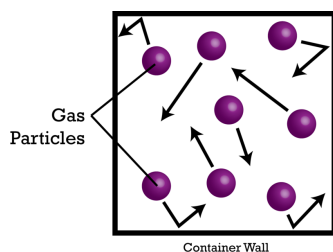

FIGURE 4.10

The particles of a gas keep bumping into the sides of its container.

What Is Pressure?

Pressure is defined as the amount of force pushing against a given area. How much pressure a gas exerts depends on the amount of gas. The more gas particles there are, the greater the pressure.

You usually cannot feel it, but air has pressure. The gases in Earth's atmosphere exert pressure against everything they contact. The atmosphere rises high above Earth's surface. It contains a huge number of individual gas particles. As a result, the pressure of the tower of air above a given spot on Earth's surface is substantial. If you were standing

at sea level, the amount of force would be equal to 10.14 newtons per square centimeter (14.7 pounds per square inch). This is illustrated in **Figure 4.11**.

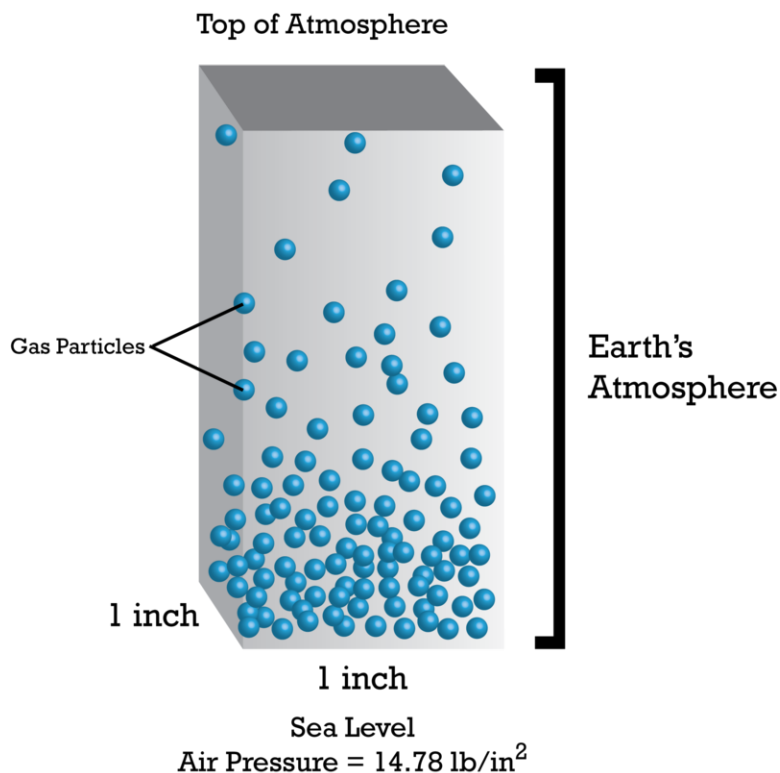

FIGURE 4.11

Earth's atmosphere exerts pressure. This pressure is greatest at sea level. Can you explain why?

The Gas Laws

For a given amount of gas, scientists have discovered that the pressure, volume, and temperature of a gas are related in certain ways. Because these relationships always hold in nature, they are called laws. The laws are named for the scientists that discovered them.

Boyle's Law

Boyle's law was discovered in the 1600s by an Irish chemist named Robert Boyle. According to **Boyle's law**, if the temperature of a gas is held constant, increasing the volume of the gas decreases its pressure. Why is this the case? As the volume of a gas increases, its particles have more room to spread out. This means that there are fewer particles bumping into any given area. This decreases the pressure of the gas. The graph in **Figure 4.12** shows this relationship between volume and pressure. Because pressure and volume change in opposite directions, their relationship is called an inverse relationship. You can see an animation of the relationship at this URL: <http://www.grc.nasa.gov/WWW/K-12/airplane/aboyle.html> .

A scuba diver, like the one in **Figure 4.13**, releases air bubbles when he breathes under water. As he gets closer to the surface of the water, the air bubbles get bigger. Boyle's law explains why. The pressure of the water decreases as the diver gets closer to the surface. Because the bubbles are under less pressure, they increase in volume even though the amount of gas in the bubbles remains the same.

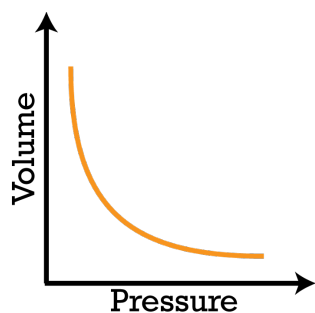
**FIGURE 4.12**

As the volume of a gas increases, its pressure decreases.

**FIGURE 4.13**

Gas bubbles get bigger when they are under less pressure.

Charles's Law

Charles's law was discovered in the 1700s by a French physicist named Jacques Charles. According to **Charles's law**, if the pressure of a gas is held constant, increasing the temperature of the gas increases its volume. What happens when a gas is heated? Its particles gain energy. With more energy, the particles have a greater speed. Therefore, they can move more and spread out farther. The volume of the gas increases as it expands and takes up more space. The graph in **Figure 4.14** shows this relationship between the temperature and volume of a gas. You can see an animation of the relationship at this URL: <http://www.grc.nasa.gov/WWW/K-12/airplane/aglussac.html>

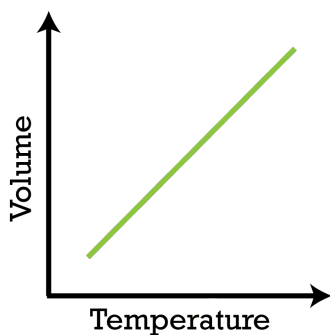
**FIGURE 4.14**

As the temperature of a gas increases, its volume also increases.

Roger had a latex balloon full of air inside his air-conditioned house. When he took the balloon outside in the hot sun, it got bigger and bigger until it popped. Boyle's law explains why. As the gas in the balloon warmed in the sun, its volume increased. It stretched and expanded the latex of the balloon until the balloon burst.

Amontons's Law

Amontons's law was discovered in the late 1600s by a French physicist named Guillaume Amontons. According to **Amontons's law**, if the volume of a gas is held constant, increasing the temperature of the gas increases its pressure. Why is this the case? A heated gas has more energy. Its particles move more and have more collisions, so the pressure of the gas increases. The graph in **Figure 4.15** shows this relationship.

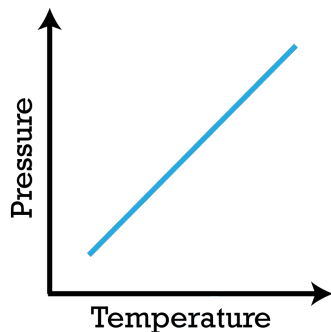

FIGURE 4.15

As the temperature of a gas increases, its pressure increases as well.

A woman checked the air pressure in her tires before driving her car on a cold day (see **Figure 4.16**). The tire pressure gauge registered 29 pounds of pressure per square inch. After driving the car several miles on the highway, the woman stopped and checked the tire pressure again. This time the gauge registered 32 pounds per square inch. Amontons's law explains what happened. As the tires rolled over the road, they got warmer. The air inside the tires also warmed. As it did, its pressure increased.



FIGURE 4.16

A tire pressure gauge measures the pressure of the air inside a car tire. Why is the pressure likely to increase as the car is driven?

Lesson Summary

- Particles of a gas are constantly moving and bumping into things. This gives gases pressure.
- The gas laws describe the relationship among pressure, volume, and temperature of a given amount of gas.

Lesson Review Questions

Recall

1. Define pressure.
2. Why do gases exert pressure?
3. What is Boyle's law?
4. State Charles's law.

Apply Concepts

5. Assume you have a closed glass container that contains only air. If you heat the air in the closed container, it will gain energy. What other property of the air will also change?
6. Draw a graph to show the relationship between the volume and pressure of a fixed amount of gas.

Think Critically

7. A weather balloon is released at Earth's surface. It rises high in the atmosphere. As the balloon rises, it expands and eventually bursts. Explain why.

Points to Consider

In this lesson, you read that heating a gas gives its particles more kinetic energy. As a result, its volume or pressure also increases. The opposite happens when a gas is cooled.

- What might happen if you cool a gas to an even lower temperature? Might it change state and become a liquid?
- Can you predict the role of energy in changes of state?

4.3 Changes of State

Lesson Objectives

- Explain the role of energy in changes of state.
- Outline the processes of freezing and melting.
- Describe vaporization and condensation.
- Define sublimation and deposition.

Vocabulary

- condensation
- deposition
- evaporation
- freezing
- melting
- sublimation
- temperature
- vaporization

Introduction

Matter is always changing state. Look at the two pictures of Mount Rushmore in **Figure 4.17**. The picture on the left was taken on a sunny summer morning. In this picture, the sky is perfectly clear. The picture on the right was taken just a few hours later. In this picture, there are clouds in the sky. The clouds consist of tiny droplets of liquid water. Where did the water come from? It was there all along in the form of invisible water vapor.



Mount Rushmore: 7:00 AM

Mount Rushmore: 10:00 AM

FIGURE 4.17

Both of these pictures of Mount Rushmore were taken on the same day just a few hours apart. Where did the clouds come from in the picture on the right?

Introduction to Changes of State

What causes clouds to form? And in general, how does matter change from one state to another? As you may have guessed, changes in energy are involved.

What Are Changes of State?

Changes of state are physical changes in matter. They are reversible changes that do not involve changes in matter's chemical makeup or chemical properties. Common changes of state include melting, freezing, sublimation, deposition, condensation, and vaporization. These changes are shown in **Figure 4.18**. Each is described in detail below.

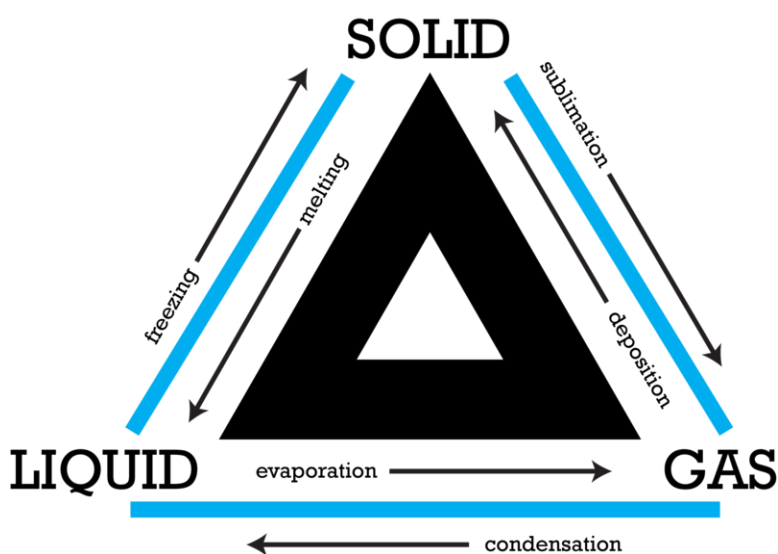

FIGURE 4.18

Which process changes a solid to a gas?
Which process changes a gas to a solid?

Energy, Temperature, and Changes of State

Energy is always involved in changes of state. Matter either loses or absorbs energy when it changes from one state to another. For example, when matter changes from a liquid to a solid, it loses energy. The opposite happens when matter changes from a solid to a liquid, matter must absorb energy from its surroundings. The amount of energy in matter can be measured with a thermometer. That's because a thermometer measures temperature, and **temperature** is the average kinetic energy of the particles of matter. You can learn more about energy, temperature, and changes of state at this URL: http://hogan.chem.lsu.edu/matter/chap26/animate3/an26_035.mov .

Changes Between Liquids and Solids

Think about how you would make ice cubes in a tray. First you would fill the tray with water from a tap. Then you would place the tray in the freezer compartment of a refrigerator. The freezer is very cold. What happens next?

Freezing

The warmer water in the tray loses heat to the colder air in the freezer. The water cools until its particles no longer have enough energy to slide past each other. Instead, they remain in fixed positions, locked in place by the forces of attraction between them. The liquid water has changed to solid ice. Another example of liquid water changing to solid ice is pictured in **Figure 4.19**.



FIGURE 4.19

Water dripping from a gutter turned to ice as it fell toward the ground, forming icicles. Why did the liquid water change to a solid?

The process in which a liquid changes to a solid is called **freezing**. The temperature at which a liquid changes to a solid is its freezing point. The freezing point of water is 0°C (32°F). Other types of matter may have higher or lower freezing points. For example, the freezing point of iron is 1535°C . The freezing point of oxygen is -219°C .

Melting

If you took ice cubes out of a freezer and left them in a warm room, the ice would absorb energy from the warmer air around it. The energy would allow the particles of frozen water to overcome some of the forces of attraction holding them together. They would be able to slip out of the fixed positions they held as ice. In this way, the solid ice would turn to liquid water.

The process in which a solid changes to a liquid is called **melting**. The melting point is the temperature at which a solid changes to a liquid. For a given type of matter, the melting point is the same as the freezing point. What is the melting point of ice? What is the melting point of iron, pictured in **Figure 4.20**?

Changes Between Liquids and Gases

If you fill a pot with cool tap water and place the pot on a hot stovetop, the water heats up. Heat energy travels from the stovetop to the pot, and the water absorbs the energy from the pot. What happens to the water next?

Vaporization

If water gets hot enough, it starts to boil. Bubbles of water vapor form in boiling water. This happens as particles of liquid water gain enough energy to completely overcome the force of attraction between them and change to the

**FIGURE 4.20**

Molten (melted) iron is poured into a mold at a foundry. It takes extremely high temperatures to change iron from a solid to the liquid shown here. That's because iron has a very high melting point.

gaseous state. The bubbles rise through the water and escape from the pot as steam.

The process in which a liquid boils and changes to a gas is called **vaporization**. The temperature at which a liquid boils is its boiling point. The boiling point of water is 100°C (212°F). Other types of matter may have higher or lower boiling points. For example, the boiling point of table salt is 1413°C . The boiling point of nitrogen is -196°C .

Evaporation

A liquid can also change to a gas without boiling. This process is called **evaporation**. It occurs when particles at the exposed surface of a liquid absorb just enough energy to pull away from the liquid and escape into the air. This happens faster at warmer temperatures. Look at the puddle in **Figure 4.21**. It formed in a pothole during a rain shower. The puddle will eventually evaporate. It will evaporate faster if the sun comes out and heats the water than if the sky remains cloudy.

Condensation

If you take a hot shower in a closed bathroom, the mirror is likely to "fog" up. The "fog" consists of tiny droplets of water that form on the cool surface of the mirror. Why does this happen? Some of the hot water from the shower evaporates, so the air in the bathroom contains a lot of water vapor. When the water vapor contacts cooler surfaces, such as the mirror, it cools and loses energy. The cooler water particles no longer have enough energy to overcome the forces of attraction between them. They come together and form droplets of liquid water.

The process in which a gas changes to a liquid is called **condensation**. Other examples of condensation are shown in **Figure 4.22**. A gas condenses when it is cooled below its boiling point. At what temperature does water vapor condense?

**FIGURE 4.21**

Evaporation of water occurs even at relatively low temperatures. The water trapped in this pothole will evaporate sooner or later.

Water vapor in the air condenses on cool blades of grass, forming dewdrops.

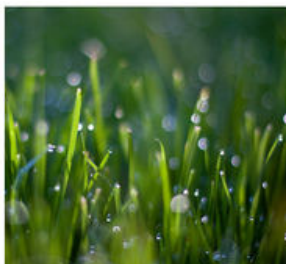

A cold drink "sweats" on a warm day when water vapor in the warm air condenses on the cold glass.



Clouds form when water vapor in the air condenses on dust particles in the atmosphere.

**FIGURE 4.22**

Water vapor condenses to form liquid water in each of the examples pictured here.

Changes Between Solids and Gases

Solids that change to gases generally first pass through the liquid state. However, sometimes solids change directly to gases and skip the liquid state. The reverse can also occur. Sometimes gases change directly to solids.

Sublimation

The process in which a solid changes directly to a gas is called **sublimation**. It occurs when the particles of a solid absorb enough energy to completely overcome the force of attraction between them. Dry ice (solid carbon dioxide, CO_2) is an example of a solid that undergoes sublimation. **Figure 4.23** shows a chunk of dry ice changing directly to carbon dioxide gas. Sometimes snow undergoes sublimation as well. This is most likely to occur on sunny winter days when the air is very dry. What gas does snow become?



FIGURE 4.23

Solid carbon dioxide changes directly to the gaseous state.

Deposition

The opposite of sublimation is **deposition**. This is the process in which a gas changes directly to a solid without going through the liquid state. It occurs when gas particles become very cold. For example, when water vapor in the air contacts a very cold windowpane, the water vapor may change to tiny ice crystals on the glass. The ice crystals are called frost. You can see an example in **Figure 4.24**.

Lesson Summary

- Changes of state are physical changes. They occur when matter absorbs or loses energy.
- Processes in which matter changes between liquid and solid states are freezing and melting.
- Processes in which matter changes between liquid and gaseous states are vaporization, evaporation, and condensation.
- Processes in which matter changes between solid and gaseous states are sublimation and deposition.

Lesson Review Questions

Recall

1. Identify the processes involved in changes of state between liquids and solids.

**FIGURE 4.24**

Frost is solid water that forms when water vapor undergoes deposition.

2. Define vaporization and evaporation. State how the two processes differ.
3. What is sublimation? Give an example.
4. Define deposition. When does it occur?

Apply Concepts

5. Cliff opened the oven door to check on the cake he was baking. As hot, moist air rushed out of the oven, his eyeglasses steamed up. Explain why.

Think Critically

6. Explain the role of energy in changes of state.
7. Form a hypothesis to explain why the melting points of different solids vary.

Points to Consider

In this chapter, you read that atoms and molecules of the same kind of matter have forces of attraction between them. Atoms consist of even smaller particles. These particles are held together by certain forces as well.

- What are the particles that make up atoms?
- What forces might hold them together?

4.4 References

1. Etienne Berthier, Université de Toulouse, NASA Goddard Space Flight Center. <http://www.flickr.com/photos/gsfsc/8741348325/> . CC BY 2.0
2. Christopher Auyeung. . CC BY-NC 3.0
3. Salt: Nate Steiner; Steaks: Jon Sullivan/pdphoto.org; Wood: Horia Varlan; Candle: Jon Sullivan/pdphoto.org;. Salt: <http://www.flickr.com/photos/nate/27476159/>; Steaks: <http://commons.wikimedia.org/wiki/File:Steaks.jpg>; Wood: <http://www.flickr.com/photos/horiavarlan/4273110809/>; Candle: http://commons.wikimedia.org/wiki/File:Candle_flame_%281%29.jpg . Salt and Wood: CC BY 2.0; Steaks and Candle: Public Domain
4. Christopher Auyeung. . CC BY-NC 3.0
5. Rain drops: Flickr:Pug50; Honey: Courtesy of Scott Bauer, USDA ARS; Vinegar: Mike McCune (Flickr:mccun934). Rain drops: <http://www.flickr.com/photos/pug50/4993906430/>; Honey: http://commons.wikimedia.org/wiki/File:Runny_hunny.jpg; Vinegar: <http://www.flickr.com/photos/mccun934/4858533603/> . Rain drops: CC BY 2.0; Honey: Public Domain; Vinegar: CC BY 2.0
6. Joe Shlabotnik. <http://www.flickr.com/photos/joeshlabotnik/1856962308/> . CC BY 2.0
7. Northern lights: Visit Greenland; TV: Paulo Ordoveza. Northern lights: <http://www.flickr.com/photos/ilovegreenland/6004907175/>; TV: <http://www.flickr.com/photos/brownpau/3957073841/> . CC BY 2.0
8. Christopher Auyeung. . CC BY-NC 3.0
9. Joy Sheng. . CC BY-NC 3.0
10. Christopher Auyeung. . CC BY-NC 3.0
11. Christopher Auyeung. [CK-12 Foundation](#) . CC BY-NC 3.0
12. Christopher Auyeung. . CC BY-NC 3.0
13. Thomas Quine. <http://www.flickr.com/photos/91994044@N00/5879957510/in/photolist-9XAjvL-cKhLPd-4FEPQs-5Ku62m> . CC BY 2.0
14. Christopher Auyeung. . CC BY-NC 3.0
15. Christopher Auyeung. . CC BY-NC 3.0
16. User:Piero/Nl.Wikipedia. <http://commons.wikimedia.org/wiki/File:PSI.JPG> . Public Domain
17. Left: Jim Bowen; Right: Mike Tigas. Left: http://commons.wikimedia.org/wiki/File:Mount_Rushmore_National_Memorial.jpg, Right: http://commons.wikimedia.org/wiki/File:Mount_Rushmore_%281%29.jpg . CC BY 2.0
18. Christopher Auyeung. . CC BY-NC 3.0
19. Flickr:Wonderlane. <http://www.flickr.com/photos/wonderlane/5203281808/> . CC BY 2.0
20. Antonis Lamnatos. <http://www.flickr.com/photos/lamnatos/2263071494/> . CC BY 2.0
21. Courtesy of the United States Geological Survey. http://commons.wikimedia.org/wiki/File:Waterpocket_in_Grand_Wash.jpg . Public Domain
22. Grass: Sean Hobson; Drink: Jenny Downing; Cloud: Paul Bica. Grass: http://www.flickr.com/photos/sean_hobson/4344458755/; Drink: <http://www.flickr.com/photos/jenny-pics/9568936573/>; Cloud: <http://www.flickr.com/photos/99771506@N00/6314857976/> . CC BY 2.0
23. Flickr:joka2000(on/off). <http://www.flickr.com/photos/joka2000/180624345/> . CC BY 2.0
24. Milan Garbiar. <http://commons.wikimedia.org/wiki/File:Window-frost.jpg> . CC BY 2.0

CHAPTER **5****Atoms**

Chapter Outline

- 5.1 INSIDE THE ATOM
- 5.2 HISTORY OF THE ATOM
- 5.3 MODERN ATOMIC THEORY
- 5.4 REFERENCES

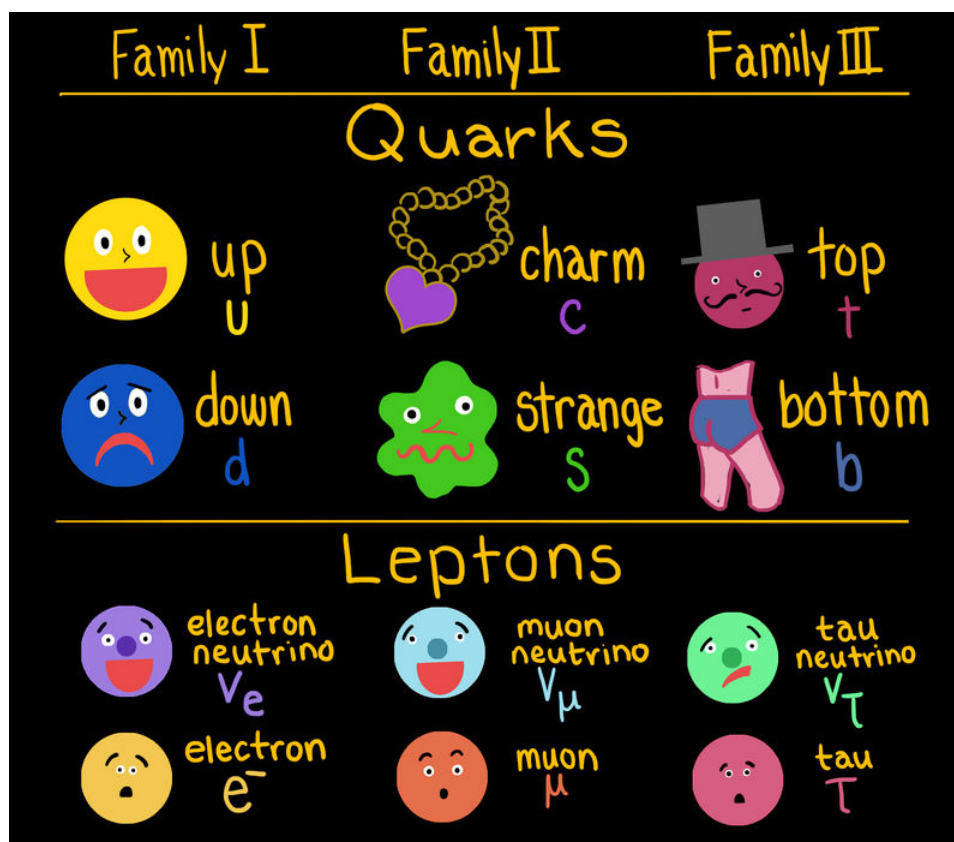

For many decades, scientists have known that atoms consist of electrons and other particles called protons and neutrons. Recently they found that there are even smaller particles in atoms. Scientists call these extremely tiny particles by the funny name of quarks. As you can see in this diagram, there are several different kinds of quarks, called up quarks, down quarks, top quarks, bottom quarks, charm quarks, and strange quarks. In this chapter you'll learn about these unusual particles and also other particles inside the atom.

5.1 Inside the Atom

Lesson Objectives

- Compare and contrast protons, neutrons, and electrons.
- Describe the forces that hold the particles of atoms together.
- Define atomic number and mass number.
- Describe ions and isotopes
- Identify the particles called quarks.

Vocabulary

- atomic mass unit (amu)
- atomic number
- electron
- ion
- isotope
- mass number
- neutron
- nucleus
- proton
- quark

Introduction

Atoms are the smallest particles of an element that still have the element's properties. They are the building blocks of all matter. Individual atoms are extremely small. In fact, they are so small that trillions of them would fit inside the period at the end of this sentence. Yet atoms, in turn, consist of even smaller particles.

Parts of the Atom

Figure 5.1 represents a simple model of an atom. You will learn about more complex models in later lessons, but this model is a good place to start. You can see similar, animated models of atoms at this URL: <http://web.jjay.cuny.edu/~acarpi/NSC/3-atoms.htm> .

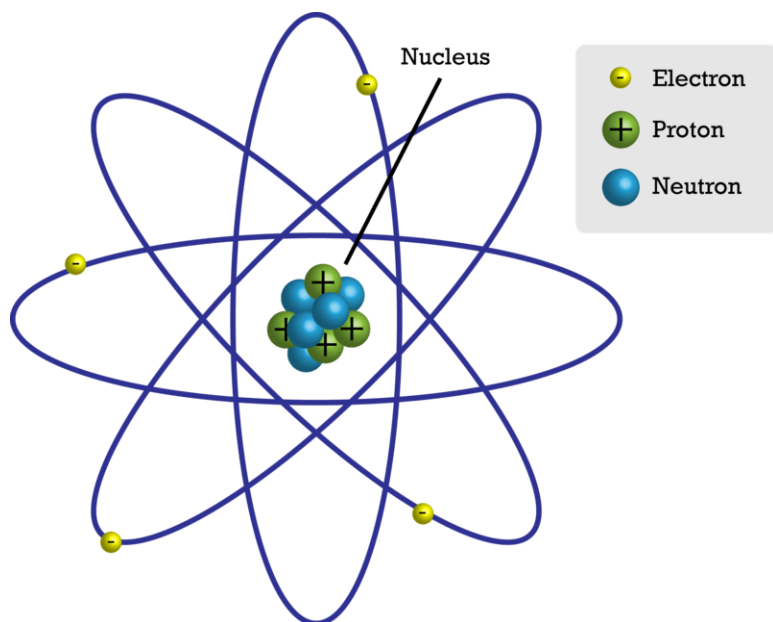
**FIGURE 5.1**

This simple atomic model shows the particles inside the atom.

The Nucleus

At the center of an atom is the **nucleus** (plural, nuclei). The nucleus contains most of the atom's mass. However, in size, it's just a tiny part of the atom. The model in **Figure 5.1** is not to scale. If an atom were the size of a football stadium, the nucleus would be only about the size of a pea.

The nucleus, in turn, consists of two types of particles, called protons and neutrons. These particles are tightly packed inside the nucleus. Constantly moving about the nucleus are other particles called electrons. You can see a video about all three types of atomic particles at this URL: <http://www.youtube.com/watch?v=1P57gEWcisY> (1:57).

Protons

A **proton** is a particle in the nucleus of an atom that has a positive electric charge. All protons are identical. It is the number of protons that gives atoms of different elements their unique properties. Atoms of each type of element have a characteristic number of protons. For example, each atom of carbon has six protons, as you can see in **Figure 5.2**. No two elements have atoms with the same number of protons.

Neutrons

A **neutron** is a particle in the nucleus of an atom that has no electric charge. Atoms of an element often have the same number of neutrons as protons. For example, most carbon atoms have six neutrons as well as six protons. This is also shown in **Figure 5.2**.

Electrons

An **electron** is a particle outside the nucleus of an atom that has a negative electric charge. The charge of an electron is opposite but equal to the charge of a proton. Atoms have the same number of electrons as protons. As a result, the negative and positive charges "cancel out." This makes atoms electrically neutral. For example, a carbon atom has six electrons that "cancel out" its six protons.

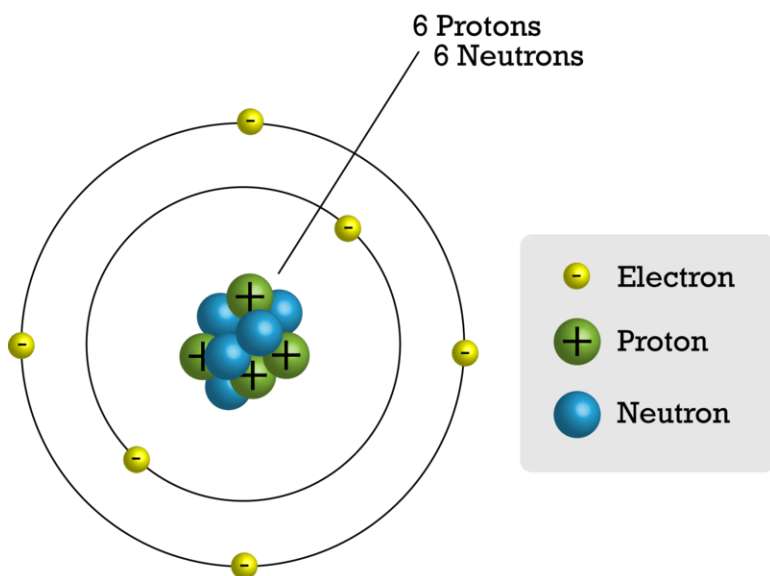

FIGURE 5.2

This model shows the particles that make up a carbon atom.

Atomic Forces

When it comes to atomic particles, opposites attract. Negative electrons are attracted to positive protons. This force of attraction keeps the electrons moving about the nucleus. An analogy is the way planets orbit the sun.

What about particles with the same charge, such as protons in the nucleus? They push apart, or repel, each other. So why doesn't the nucleus fly apart? The reason is a force of attraction between protons and neutrons called the strong force. The name of the strong force suits it. It is stronger than the electric force pushing protons apart. However, the strong force affects only nearby particles (see **Figure 5.3**). It is not effective if the nucleus gets too big. This puts an upper limit on the number of protons an atom can have and remain stable. You can learn more about atomic forces in the colorful tutorial at this URL: http://www.ric.edu/faculty/ptiskus/Atomic_Force/ .

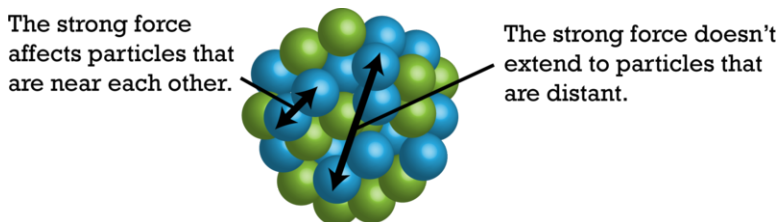

FIGURE 5.3

The strong force is effective only between particles that are very close together in the nucleus.

Atomic Number and Mass Number

Electrons have almost no mass. Instead, almost all the mass of an atom is in its protons and neutrons in the nucleus. The nucleus is very small, but it is densely packed with matter. The SI unit for the mass of an atom is the **atomic mass unit (amu)**. One atomic mass unit equals the mass of a proton, which is about 1.7×10^{-24} g. Each neutron also has a mass of 1 amu. Therefore, the sum of the protons and neutrons in an atom is about equal to the atom's

total mass in atomic mass units.

Two numbers are commonly used to distinguish atoms: atomic number and mass number. **Figure 5.4** shows how these numbers are usually written.

**FIGURE 5.4**

The symbol He stands for the element helium. Can you infer how many electrons a helium atom has?

- The **atomic number** is the number of protons in an atom. This number is unique for atoms of each kind of element. For example, the atomic number of all helium atoms is 2.
- The **mass number** is the number of protons plus the number of neutrons in an atom. For example, most atoms of helium have 2 neutrons, so their mass number is $2 + 2 = 4$. This mass number means that an atom of helium has a mass of about 4 amu.

Problem Solving

Problem: An atom has an atomic number of 12 and a mass number of 24. How many protons and neutrons does the atom have?

Solution: The number of protons is the same as the atomic number, or 12. The number of neutrons is equal to the mass number minus the atomic number, or $24 - 12 = 12$.

You Try It!

Problem: An atom has an atomic number of 8 and a mass number of 16. How many neutrons does it have? What is the atom's mass in atomic mass units?

Ions and Isotopes

The number of protons per atom is always the same for a given element. However, the number of neutrons may vary, and the number of electrons can change.

Ions

Sometimes atoms lose or gain electrons. Then they become **ions**. Ions have a positive or negative charge. That's because they do not have the same number of electrons as protons. If atoms lose electrons, they become positive ions, or cations. If atoms gain electrons, they become negative ions, or anions.

Consider the example of fluorine in **Figure 5.5**. A fluorine atom has nine protons and nine electrons, so it is electrically neutral. If a fluorine atom gains an electron, it becomes a fluoride ion with a negative charge of minus one.

Fluorine Atom (F) \longrightarrow Fluoride Ion (F⁻)

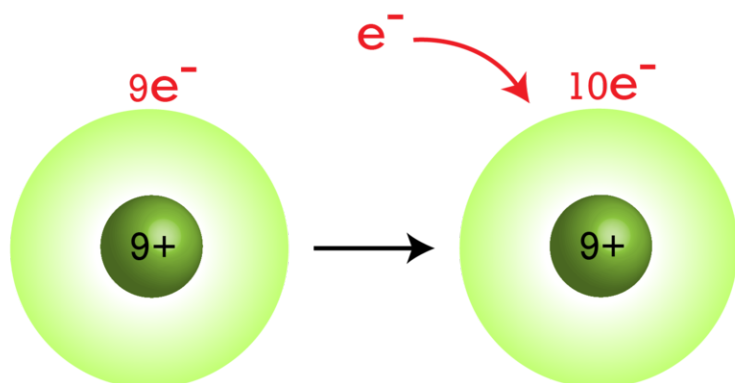
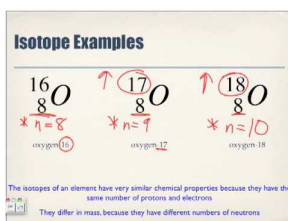

FIGURE 5.5

When a fluorine atom gains an electron, it becomes a negative fluoride ion.

Isotopes of Atoms

Some atoms of the same element may have different numbers of neutrons. For example, some carbon atoms have seven or eight neutrons instead of the usual six. Atoms of the same element that differ in number of neutrons are called **isotopes**. Many isotopes occur naturally. Usually one or two isotopes of an element are the most stable and common. Different isotopes of an element generally have the same chemical properties. That's because they have the same numbers of protons and electrons. For a video explanation of isotopes, go to this URL: <http://www.youtube.com/watch?v=6w7raarHNA8> (5:23).



MEDIA

Click image to the left for more content.

An Example: Hydrogen Isotopes

Hydrogen is a good example of isotopes because it has the simplest atoms. Three isotopes of hydrogen are modeled in **Figure 5.6**. Most hydrogen atoms have just one proton and one electron and lack a neutron. They are just called hydrogen. Some hydrogen atoms have one neutron. These atoms are the isotope named deuterium. Other hydrogen atoms have two neutrons. These atoms are the isotope named tritium.

Naming Isotopes

For most other elements, isotopes are named for their mass number. For example, carbon atoms with the usual 6 neutrons have a mass number of 12 (6 protons + 6 neutrons = 12), so they are called carbon-12. Carbon atoms with 7 neutrons have an atomic mass of 13 (6 protons + 7 neutrons = 13). These atoms are the isotope called carbon-13. Some carbon atoms have 8 neutrons. What is the name of this isotope of carbon? You can learn more about this isotope at the URL below. It is used by scientists to estimate the ages of rocks and fossils.

<http://www.khanacademy.org/video/carbon-14-dating-1?playlist=Chemistry>

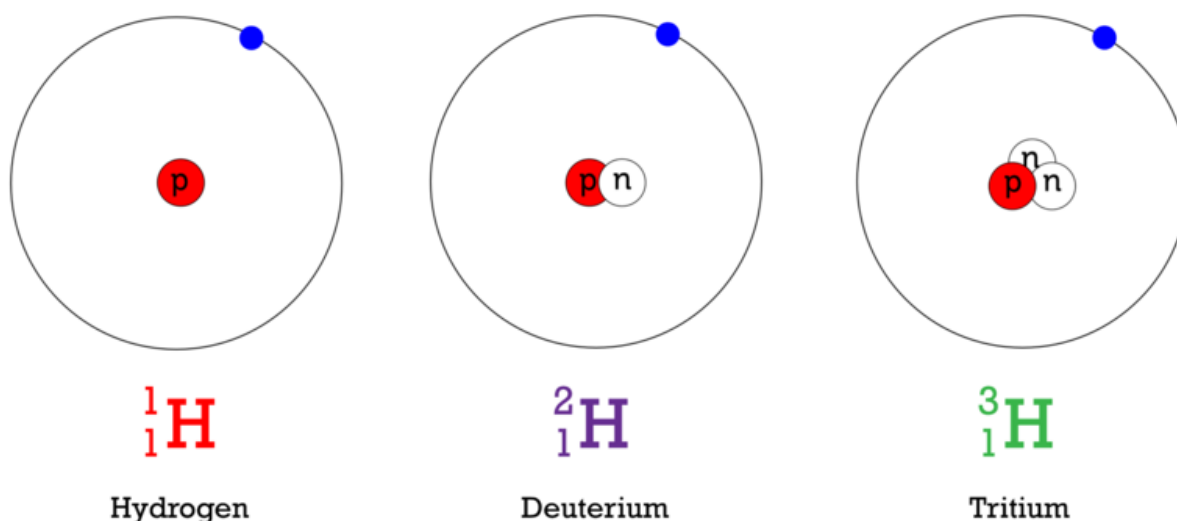

FIGURE 5.6

All isotopes of a given element have the same number of protons (P), but they differ in the number of neutrons (N). What is the mass number of each isotope shown here?

Back to Quarks

Remember the quarks from the first page of this chapter? **Quarks** are even tinier particles of matter that make up protons and neutrons. There are three quarks in each proton and three quarks in each neutron. The charges of quarks are balanced exactly right to give a positive charge to a proton and a neutral charge to a neutron. It might seem strange that quarks are never found alone but only as components of other particles. This is because the quarks are held together by very strange particles called gluons.

Gluons

Gluons make quarks attract each other more strongly the farther apart the quarks get. To understand how gluons work, imagine holding a rubber band between your fingers. If you try to move your hands apart, they will be pulled back together by the rubber band. The farther apart you move your hands, the stronger the force of the rubber band pulling your hands together. Gluons work the same way on quarks inside protons and neutrons (and other, really rare particles too).

If you were to move your hands apart with enough force, the rubber band holding them together would break. The same is true of quarks. If they are given enough energy, they pull apart with enough force to "break" the binding from the gluons. However, all the energy that is put into a particle to make this possible is then used to create a new set of quarks and gluons. And so a new proton or neutron appears.

Finding Quarks

The existence of quarks was first proposed in the 1960s. Since then, scientists have done experiments to show that quarks really do exist. In fact, they have identified six different types of quarks. However, much remains to be learned about these tiny, fundamental particles of matter. They are very difficult and expensive to study. If you want to learn more about them, including how they are studied, the URL below is a good place to start.

<http://www.particleadventure.org/index.html>

Lesson Summary

- The nucleus is at the center of the atom. It contains positive protons and neutral neutrons. Negative electrons constantly move about the nucleus.
- Atomic number is the number of protons in an atom. It is unique for the atoms of each element. Mass number is the number of protons plus neutrons in an atom. It is about equal to the mass of the atom in atomic mass units (amu).
- Negative electrons are attracted to positive protons, and this electric force keeps electrons moving about the nucleus. The force of attraction between protons and neutrons, called the strong force, holds the nucleus together.
- If atoms lose or gain electrons, they become positive or negative ions. Atoms of the same element that have different numbers of neutrons are called isotopes.
- Quarks are even tinier particles of matter that make up protons and neutrons. Scientists have identified six different types of quarks.

Lesson Review Questions

Recall

1. Describe the nucleus of an atom.
2. Outline the forces that hold particles together in an atom.
3. What does the atomic number of an atom represent?
4. Define isotope. Give an example.
5. What are quarks?

Apply Concepts

6. If an atom gains electrons, it becomes an ion. Is the ion positively or negatively charged? Explain your answer.
7. What is the atomic mass (in atomic mass units) of the atom represented by the model below?

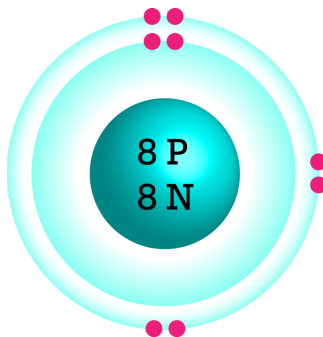

Think Critically

8. Make a table comparing and contrasting protons, neutrons, and electrons. Include their location, mass, and electric charge.
9. Explain why atoms are neutral in electric charge.

Points to Consider

In this lesson, you saw several simple models of atoms. Models are useful for representing things that are very small. Scientists have used models to represent atoms for more than 200 years. In the next lesson, "History of the Atom," you'll read about some of the earlier models.

- How might scientists have modeled atoms before the particles inside atoms were discovered?
- How do you think earlier models might have differed from the models in this lesson?

5.2 History of the Atom

Lesson Objectives

- State Democritus's ideas about the atom.
- Outline Dalton's atomic theory.
- Explain how Thomson discovered electrons.
- Describe how Rutherford found the nucleus.

Introduction

Atoms are very tiny. They could not be seen before scanning tunneling microscopes were invented in 1981. However, the idea of atoms goes back to ancient Greece. That's where this brief history of the atom begins. You can watch a video about the history of the atom at this URL: <http://www.youtube.com/watch?v=sxQIzPejhO8> .

Democritus Introduces the Atom

The history of the atom begins around 450 B.C. with a Greek philosopher named Democritus (see **Figure 5.7**). Democritus wondered what would happen if you cut a piece of matter, such as an apple, into smaller and smaller pieces. He thought that a point would be reached where matter could not be cut into still smaller pieces. He called these "uncuttable" pieces *atomos*. This is where the modern term atom comes from.



FIGURE 5.7

Democritus first introduced the idea of the atom almost 2500 years ago.

Democritus was an important philosopher. However, he was less influential than the Greek philosopher Aristotle, who lived about 100 years after Democritus. Aristotle rejected Democritus's idea of atoms. In fact, Aristotle thought

the idea of atoms was ridiculous. Unfortunately, Aristotle's ideas were accepted for more than 2000 years. During that time, Democritus's ideas were more or less forgotten.

Dalton Brings Back the Atom

Around 1800, a British chemist named John Dalton revived Democritus's early ideas about the atom. Dalton is pictured in **Figure 5.8**. He made a living by teaching and just did research in his spare time. Nonetheless, from his research results, he developed one of the most important theories in science.

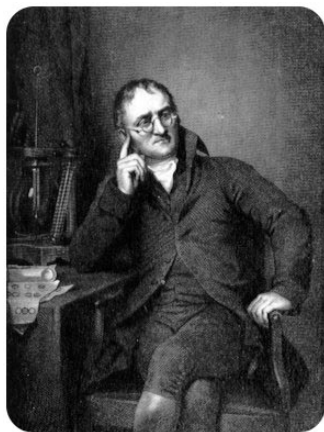

FIGURE 5.8

John Dalton used evidence from experiments to show that atoms exist.

Dalton's Research

Dalton did many experiments that provided evidence for atoms. For example, he studied the pressure of gases. He concluded that gases must consist of tiny particles in constant motion. Dalton also researched the properties of compounds. He showed that a compound always consists of the same elements in the same ratio. On the other hand, different compounds always consist of different elements or ratios. This can happen, Dalton reasoned, only if elements are made of tiny particles that can combine in an endless variety of ways. From his research, Dalton developed a theory of the atom. You can learn more about Dalton and his research by watching the video at this URL: <http://www.youtube.com/watch?v=BhWgv0STLZs&feature=related> (9:03).



MEDIA

Click image to the left for more content.

Dalton's Atomic Theory

The atomic theory Dalton developed consists of three ideas:

- All substances are made of atoms. Atoms are the smallest particles of matter. They cannot be divided into smaller particles. They also cannot be created or destroyed.

- All atoms of the same element are alike and have the same mass. Atoms of different elements are different and have different masses.
- Atoms join together to form compounds. A given compound always consists of the same kinds of atoms in the same ratio.

Dalton's theory was soon widely accepted. Most of it is still accepted today. The only part that is no longer accepted is his idea that atoms are the smallest particles. Scientists now know that atoms consist of even smaller particles.

Dalton's Atomic Models

Dalton incorrectly thought that atoms are tiny solid particles of matter. He used solid wooden balls to model them. The sketch in the **Figure 5.9** shows how Dalton's model atoms looked. He made holes in the balls so they could be joined together with hooks. In this way, the balls could be used to model compounds. When later scientists discovered subatomic particles (particles smaller than the atom itself), they realized that Dalton's models were too simple. They didn't show that atoms consist of even smaller particles. Models including these smaller particles were later developed.



FIGURE 5.9

Dalton's model atoms were hard, solid balls. How do they differ from the atomic models you saw in the lesson "Inside the Atom" from earlier in the chapter?

Thomson Adds Electrons

The next major advance in the history of the atom was the discovery of electrons. These were the first subatomic particles to be identified. They were discovered in 1897 by a British physicist named J. J. Thomson. You can learn more about Thomson and his discovery at this online exhibit: <http://www.aip.org/history/electron/> .

Thomson's Vacuum Tube Experiments

Thomson was interested in electricity. He did experiments in which he passed an electric current through a vacuum tube. The experiments are described in **Figure 5.10**.

Thomson's experiments showed that an electric current consists of flowing, negatively charged particles. Why was this discovery important? Many scientists of Thomson's time thought that electric current consists of rays, like rays of light, and that it is positive rather than negative. Thomson's experiments also showed that the negative particles are all alike and smaller than atoms. Thomson concluded that the negative particles couldn't be fundamental units of matter because they are all alike. Instead, they must be parts of atoms. The negative particles were later named electrons.

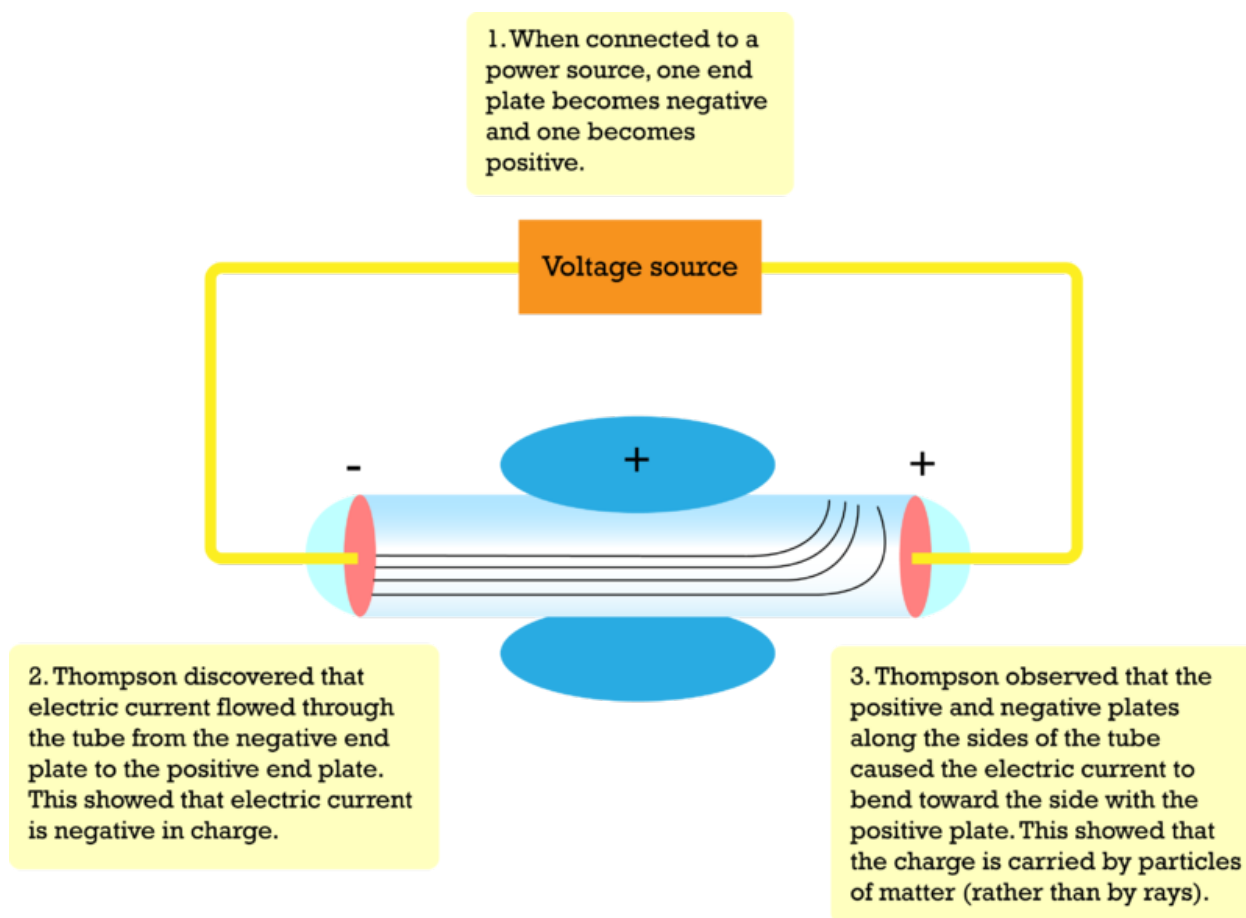

FIGURE 5.10

This sketch shows the basic set up of Thomson's experiments. The vacuum tube is a glass tube that contains very little air. It has metal plates at each end and along the sides.

Thomson's Plum Pudding Model

Thomson knew that atoms are neutral in electric charge. So how could atoms contain negative particles? Thomson thought that the rest of the atom must be positive to cancel out the negative charge. He said that an atom is like a plum pudding, which has plums scattered through it. That's why Thomson's model of the atom is called the plum pudding model. You can see it in **Figure 5.11**. It shows the atom as a sphere of positive charge (the pudding) with negative electrons (the plums) scattered through it.

Rutherford Finds the Nucleus

A physicist from New Zealand named Ernest Rutherford made the next major discovery about atoms. He discovered the nucleus. You can watch a video about Rutherford and his discovery at this URL: <http://www.youtube.com/watch?v=wzALbzTdnc8> (3:28).

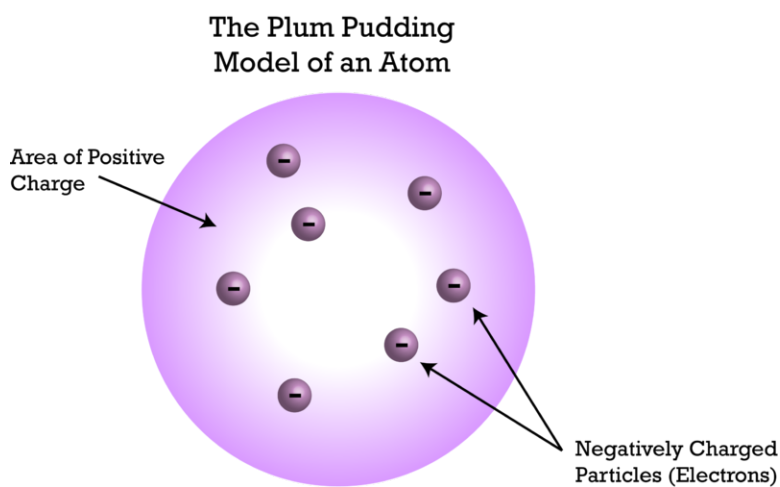
**FIGURE 5.11**

Thomson's atomic model includes negative electrons in a "sea" of positive charge.

**MEDIA**

Click image to the left for more content.

Rutherford's Gold Foil Experiments

In 1899, Rutherford discovered that some elements give off positively charged particles. He named them alpha particles (α). In 1911, he used alpha particles to study atoms. He aimed a beam of alpha particles at a very thin sheet of gold foil. Outside the foil, he placed a screen of material that glowed when alpha particles struck it.

If Thomson's plum pudding model were correct, the alpha particles should be deflected a little as they passed through the foil. Why? The positive "pudding" part of gold atoms would slightly repel the positive alpha particles. This would cause the alpha particles to change course. But Rutherford got a surprise. Most of the alpha particles passed straight through the foil as though they were moving through empty space. Even more surprising, a few of the alpha particles bounced back from the foil as though they had struck a wall. This is called back scattering. It happened only in very small areas at the centers of the gold atoms.

The Nucleus and Its Particles

Based on his results, Rutherford concluded that all the positive charge of an atom is concentrated in a small central area. He called this area the nucleus. Rutherford later discovered that the nucleus contains positively charged particles. He named the positive particles protons. Rutherford also predicted the existence of neutrons in the nucleus. However, he failed to find them. One of his students, a physicist named James Chadwick, went on to discover neutrons in 1932. You learn how at this URL: <http://www.light-science.com/chadwick.html> .

Rutherford's Atomic Model

Rutherford's discoveries meant that Thomson's plum pudding model was incorrect. Positive charge is not spread out everywhere in an atom. It is all concentrated in the tiny nucleus. The rest of the atom is empty space, except for the electrons moving randomly through it. In Rutherford's model, electrons move around the nucleus in random orbits.

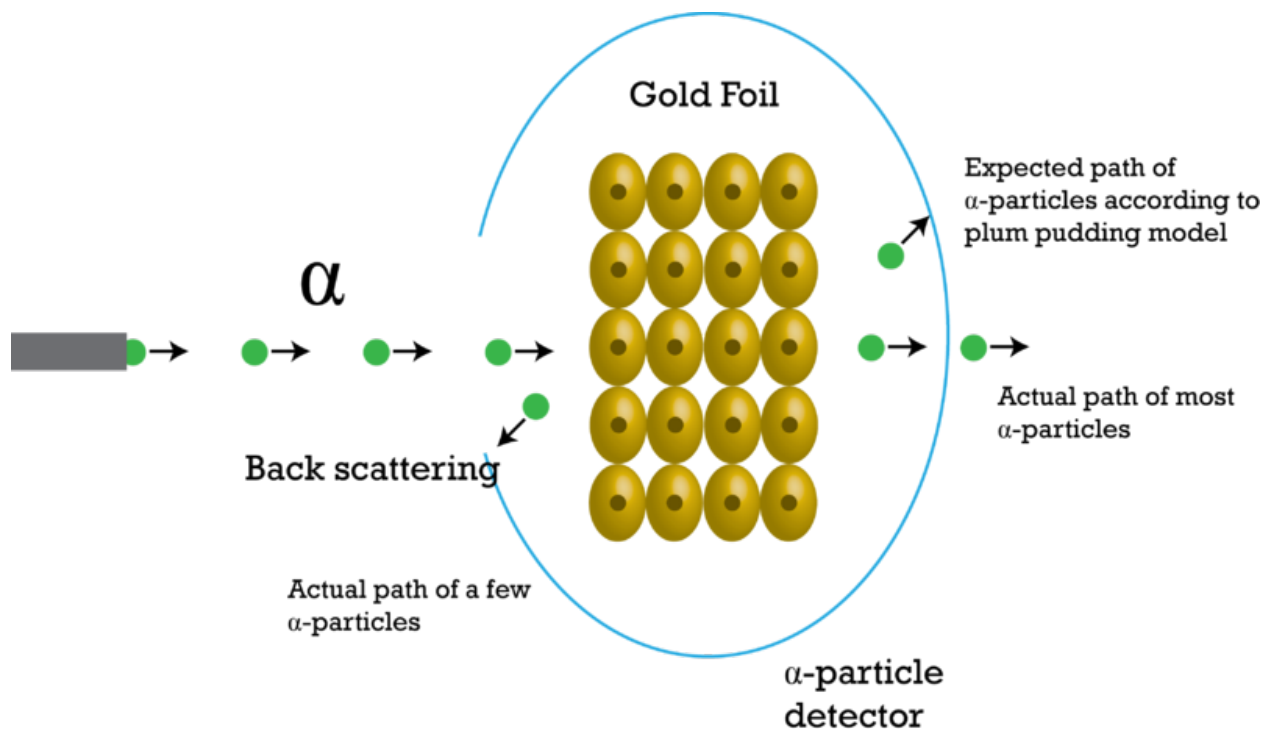
FIGURE 5.12

Rutherford shot a beam of positive alpha particles at thin gold foil.

He compared them to planets orbiting a star. That's why Rutherford's model is called the planetary model. You can see it in **Figure 5.13**.

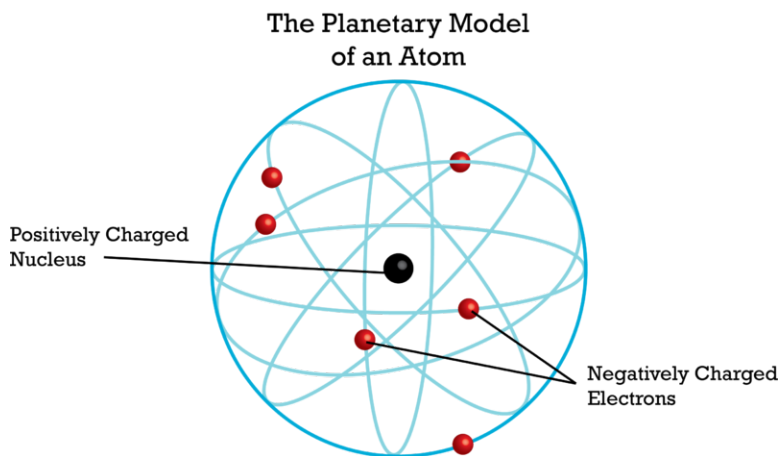
FIGURE 5.13

This model shows Rutherford's idea of the atom. How does it compare with Thomson's plum pudding model?

Lesson Summary

- Around 450 B.C., the Greek philosopher Democritus introduced the idea of the atom. However, the idea was essentially forgotten for more than 2000 years.
- In 1800, John Dalton re-introduced the atom. He provided evidence for atoms and developed atomic theory. His theory is essentially correct. However, he incorrectly thought that atoms are the smallest particles of matter.
- In 1897, J.J. Thomson discovered electrons. He proposed the plum pudding model of the atom. In this model, negative electrons are scattered throughout a "sea" of positive charge.
- In 1911, Ernest Rutherford discovered the nucleus. He later discovered protons as well. Rutherford thought that electrons randomly orbit the nucleus.

Lesson Review Questions

Recall

1. State Democritus's ideas about the atom.
2. What evidence did Dalton use to argue for the existence of atoms?
3. State Dalton's atomic theory.
4. Describe how Thomson discovered electrons.

Apply Concepts

5. Create sketches to compare and contrast Thomson's and Rutherford's models of the atom.

Think Critically

6. Based on Rutherford's work, use evidence and reasoning to argue for the existence of the nucleus.

Points to Consider

In this lesson, you read how models of the atom changed as scientists discovered the particles that make up atoms. In the next lesson, "Modern Atomic Theory," you will read how Rutherford's model was revised as scientists learned even more about electrons. For example, they discovered that electrons do not travel around the nucleus in random orbits as Rutherford thought.

- Can you predict how electrons might move around the nucleus?
- How might Rutherford's model be changed to show this?

5.3 Modern Atomic Theory

Lesson Objectives

- Define energy levels.
- Describe the electron cloud and orbitals.

Vocabulary

- electron cloud
- energy level
- orbital

Introduction

Rutherford's model of the atom was better than earlier models. But it wasn't the last word. Danish physicist Niels Bohr created a more accurate and useful model. Bohr's model was an important step in the development of modern atomic theory. The video at the URL below is a good introduction to modern atomic theory. It also reviews important concepts from the previous two lessons, "Inside the Atom" and "History of the Atom."

<http://www.khanacademy.org/video/introduction-to-the-atom?playlist=Chemistry>

Bohr's Model of the Atom

Bohr's research focused on electrons. In 1913, he discovered evidence that the orbits of electrons are located at fixed distances from the nucleus. Remember, Rutherford thought that electrons orbit the nucleus at random. **Figure 5.14** shows Bohr's model of the atom.

Energy Levels

Basic to Bohr's model is the idea of energy levels. **Energy levels** are areas located at fixed distances from the nucleus of the atom. They are the only places where electrons can be found. Energy levels are a little like rungs on a ladder. You can stand on one rung or another but not between the rungs. The same goes for electrons. They can occupy one energy level or another but not the space between energy levels.

The model of an atom in **Figure 5.15** has six energy levels. The level with the least energy is the one closest to the nucleus. As you go farther from the nucleus, the levels have more and more energy. Electrons can jump from one energy level to another. If an atom absorbs energy, some of its electrons can jump to a higher energy level.

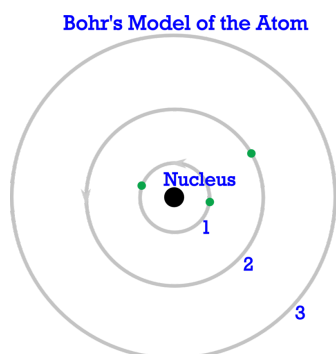
**FIGURE 5.14**

In Bohr's atomic model, electrons orbit at fixed distances from the nucleus. These distances are called energy levels.

If electrons jump to a lower energy level, the atom emits, or gives off, energy. You can see an animation at this happening at the URL below.

<http://cas.sdss.org/dr6/en/proj/advanced/spectraltypes/energylevels.asp>

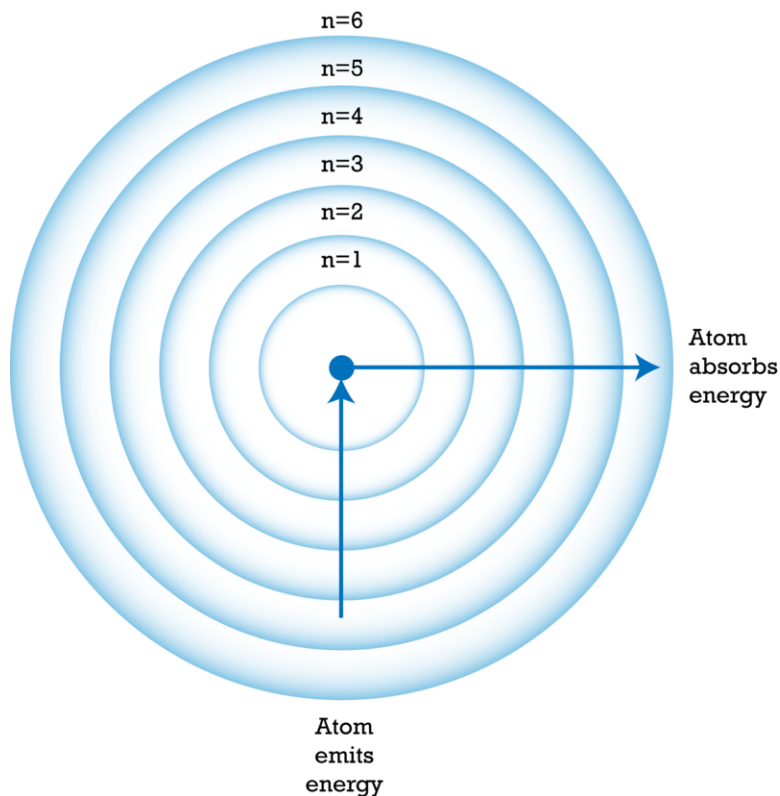
**FIGURE 5.15**

This model of an atom contains six energy levels ($n = 1$ to 6). Atoms absorb or emit energy when some of their electrons jump to a different energy level.

Energy Levels in Action

Bohr's idea of energy levels is still useful today. It helps explain how matter behaves. For example, when chemicals in fireworks explode, their atoms absorb energy. Some of their electrons jump to a higher energy level. When the electrons move back to their original energy level, they give off the energy as light. Different chemicals have different arrangements of electrons, so they give off light of different colors. This explains the blue- and purple-colored fireworks in **Figure 5.16**.

**FIGURE 5.16**

Atoms in fireworks give off light when their electrons jump back to a lower energy level.

Electron Cloud and Orbitals

In the 1920s, physicists discovered that electrons do not travel in fixed paths. In fact, they found that electrons only have a certain chance of being in any particular place. They could only describe where electrons are with mathematical formulas. That's because electrons have wave-like properties as well as properties of particles of matter. It is the "wave nature" of electrons that lets them exist only at certain distances from the nucleus. The negative electrons are attracted to the positive nucleus. However, because the electrons behave like waves, they bend around the nucleus instead of falling toward it. Electrons exist only where the wave is stable. These are the orbitals. They do not exist where the wave is not stable. These are the places between orbitals.

Electron Cloud Model

Today, these ideas about electrons are represented by the electron cloud model. The **electron cloud** is an area around the nucleus where electrons are likely to be. **Figure 5.17** shows an electron cloud model for a helium atom.

Orbitals

Some regions of the electron cloud are denser than others. The denser regions are areas where electrons are most likely to be. These regions are called **orbitals**. Each orbital has a maximum of just two electrons. Different energy levels in the cloud have different numbers of orbitals. Therefore, different energy levels have different maximum numbers of electrons. **Table 5.1** lists the number of orbitals and electrons for the first four energy levels. Energy

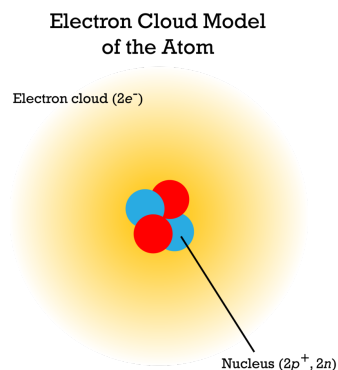
**FIGURE 5.17**

This sketch represents the electron cloud model for helium. What does the electron cloud represent?

levels farther from the nucleus have more orbitals. Therefore, these levels can hold more electrons.

TABLE 5.1: First Four Energy Levels and Their Orbitals

Energy Level	Number of Orbitals	Max. No. of Electrons (@ 2 per orbital)
1	1	2
2	4	8
3	9	18
4	16	32

Figure 5.18 shows the arrangement of electrons in an atom of magnesium as an example. The most stable arrangement of electrons occurs when electrons fill the orbitals at the lowest energy levels first before more are added at higher levels. You can learn more about orbitals and their electrons at the URL below: <http://www.khanacademy.org/video/orbitals?playlist=Chemistry> .

Energy Levels and Electrons of Magnesium (Mg)

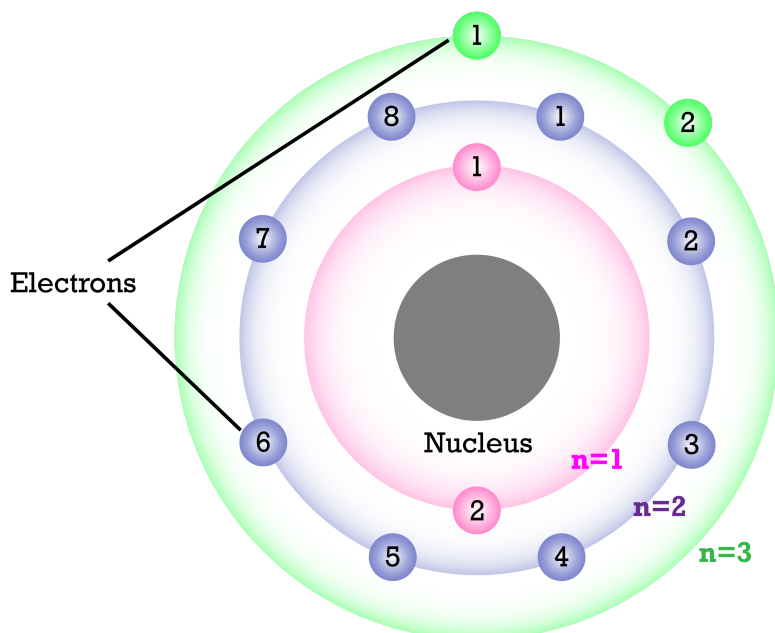
**FIGURE 5.18**

This model represents an atom of the element magnesium (Mg). How many electrons does the atom have at each energy level? What is the maximum number it could have at each level?

Lesson Review Questions

Recall

1. What are energy levels?
2. Which energy level has the smallest amount of energy?
3. Define orbitals.
4. How many electrons can be found in an orbital?

Apply Concepts

5. A change in energy caused an electron in an atom to jump from energy level 2 to energy level 3. Did the atom gain or lose energy? Explain.
6. Create a sketch to model the concept of the electron cloud.

Think Critically

7. Explain how orbitals are related to energy levels.

Points to Consider

In this chapter, you learned that atoms of each element have a unique number of protons. This is one way that each element differs from all other elements.

- How could the number of protons be used to organize elements?
- If one element has more protons than another element, how do their numbers of electrons compare?

5.4 References

1. Christopher Auyeung. [CK-12 Foundation](#) . CC BY-NC 3.0
2. Christopher Auyeung. [CK-12 Foundation](#) . CC BY-NC 3.0
3. Christopher Auyeung. [CK-12 Foundation](#) . CC BY-NC 3.0
4. Christopher Auyeung. [CK-12 Foundation](#) . CC BY-NC 3.0
5. Christopher Auyeung. [CK-12 Foundation](#) . CC BY-NC 3.0
6. Christopher Auyeung. [CK-12 Foundation](#) . CC BY-NC 3.0
7. Agostino Carracci. http://commons.wikimedia.org/wiki/File:Democritus_by_Agostino_Carracci.jpg . Public Domain
8. Henry Roscoe (author), William Henry Worthington (engraver), and Joseph Allen (painter). <http://commons.wikimedia.org/wiki/File:Johndalton.jpg> . Public Domain
9. Christopher Auyeung. [CK-12 Foundation](#) . CC BY-NC 3.0
10. Christopher Auyeung. [CK-12 Foundation](#) . CC BY-NC 3.0
11. Christopher Auyeung. [CK-12 Foundation](#) . CC BY-NC 3.0
12. Christopher Auyeung. [CK-12 Foundation](#) . CC BY-NC 3.0
13. Christopher Auyeung. [CK-12 Foundation](#) . CC BY-NC 3.0
14. Joy Sheng. [CK-12 Foundation](#) . CC BY-NC 3.0
15. Christopher Auyeung. [CK-12 Foundation](#) . CC BY-NC 3.0
16. Bob Jagendorf. <http://www.flickr.com/photos/bobjagendorf/9214248984/> . CC BY 2.0
17. Christopher Auyeung. [CK-12 Foundation](#) . CC BY-NC 3.0
18. Christopher Auyeung. [CK-12 Foundation](#) . CC BY-NC 3.0

CHAPTER

6

Periodic Table

Chapter Outline

- 6.1 HOW ELEMENTS ARE ORGANIZED
- 6.2 CLASSES OF ELEMENTS
- 6.3 GROUPS OF ELEMENTS
- 6.4 REFERENCES



Imagine going to the library and finding all the books in big messy piles like the one above. It could take a very long time to find the book you wanted. You might give up without even trying. Of course, in most libraries, books are arranged in an orderly way, like the books shown below. For example, novels, like those pictured here, are arranged in alphabetical order by author's last name. Not only can you quickly find the book you want, you can also scan the books nearby to find others by the same author. It's clear that grouping books in an organized way is very useful.



The same is true of chemical elements. For many years, scientists looked for a good way to organize them. This became increasingly important as more and more elements were discovered. In this chapter, you'll read how elements were first organized and how they are organized today. You'll see why an orderly arrangement of elements, like the books in a library, is also very useful.

Stacks image copyright Vladimir Melnikov, 2013. www.shutterstock.com. Used under licenses from Shutterstock.com. Shelves image copyright cycreation, 2013. www.s

6.1 How Elements Are Organized

Lesson Objectives

- Describe Mendeleev's periodic table of the elements.
- Give an overview of the modern periodic table of the elements.

Vocabulary

- group
- period
- periodic table

Introduction

Scientists first started looking for a way to organize the elements in the 1700s. They were trying to find a method to group together elements with similar properties. No one could come up with a good solution. It wasn't until the 1860s that a successful method was devised. It was developed by a Russian chemist named Dmitri Mendeleev. He is pictured in **Figure 6.1**. You can learn more about him and his work at this URL: <http://videos.howstuffworks.com/science-channel/27862-100-greatest-discoveries-the-periodic-table-video.htm> .

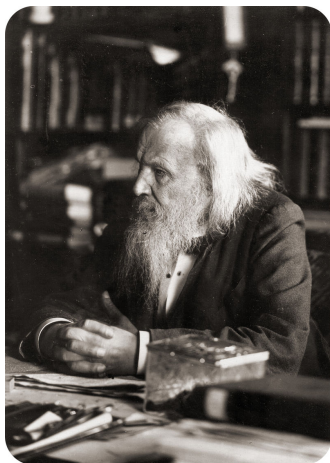

FIGURE 6.1

Dmitri Mendeleev developed the first periodic table of the elements in 1869.

Mendeleev's Periodic Table of the Elements

Mendeleev was a teacher as well as a chemist. He was writing a chemistry textbook and needed a way to organize the elements so it would be easier for students to learn about them. He made a set of cards of the elements, similar to a deck of playing cards, with one element per card. On the card, he wrote the element's name, atomic mass, and known properties. He arranged and rearranged the cards in many different ways, looking for a pattern. He finally found it when he placed the elements in order by atomic mass.

A Repeating Pattern

You can see how Mendeleev organized the elements in **Figure 6.2**. From left to right across each row, elements are arranged by increasing atomic mass. Mendeleev discovered that if he placed eight elements in each row and then continued on to the next row, the columns of the table would contain elements with similar properties. He called the columns **groups**. They are sometimes called families, because elements within a group are similar but not identical to one another, like people in a family.

Reihen	Gruppe I. — R ⁰	Gruppe II. — R ⁰	Gruppe III. — R ⁰	Gruppe IV. RH ⁴ R ⁰	Gruppe V. RH ³ R ⁰	Gruppe VI. RH ² R ⁰	Gruppe VII. RH R ⁰	Gruppe VIII. — R ⁰
1	II=1							
2	Li=7	Be=9,4	B=11	C=12	N=14	O=16	F=19	
3	Na=23	Mg=24	Al=27,3	Si=28	P=31	S=32	Cl=35,5	
4	K=39	Ca=40	—=44	Ti=48	V=51	Cr=52	Mn=55	Fe=56, Co=59, Ni=60, Cu=63.
5	(Cu=63)	Zn=65	—=68	—=72	As=75	So=78	Br=80	
6	Rb=85	Sr=87	?Yt=88	Zr=90	Nb=94	Mo=96	—=100	Ru=104, Rh=104, Pd=106, Ag=108.
7	(Ag=108)	Cd=112	In=113	Sn=118	Sb=122	Te=125	J=127	
8	Cs=133	Ba=137	?Di=138	?Ce=140	—	—	—	— — — —
9	(—)	—	—	—	—	—	—	
10	—	—	?Er=178	?La=180	Ta=182	W=184	—	Os=195, Ir=197, Pt=198, Au=199.
11	(Au=199)	Hg=200	Tl=204	Pb=207	Bi=208	—	—	
12	—	—	—	Th=231	—	U=240	—	— — — —

FIGURE 6.2

Mendeleev's table of the elements organizes the elements by atomic mass. The table has a repeating pattern.

Mendeleev's table of the elements is called a **periodic table** because of its repeating pattern. Anything that keeps repeating is referred to as periodic. Other examples of things that are periodic include the monthly phases of the moon and the daily cycle of night and day. The term **period** refers to the interval between repetitions. In a periodic table, the periods are the rows of the table. In Mendeleev's table, each period contains eight elements, and then the pattern repeats in the next row.

Predicting Missing Elements

Did you notice the blanks in Mendeleev's table (**Figure 6.2**)? They are spaces that Mendeleev left for elements that had not yet been discovered when he created his table. He predicted that these missing elements would eventually be discovered. Based on their position in the table, he could even predict their properties. For example, he predicted a missing element in row 5 of his group 3. He said it would have an atomic mass of about 68 and be a soft metal like other group 3 elements. Scientists searched for the missing element. They found it a few years later and named it gallium. Scientists searched for the other missing elements. Eventually, all of them were found.

An important measure of a good model is its ability to make accurate predictions. This makes it a useful model. Clearly, Mendeleev's periodic table was a useful model. It helped scientists discover new elements and make sense of those that were already known.

The Modern Periodic Table of the Elements

A periodic table is still used today to classify the elements. **Figure 6.3** shows the modern periodic table. You can see an interactive version at this URL: <http://www.ptable.com/> .

Basis of the Modern Periodic Table

In the modern periodic table, elements are organized by atomic number. The atomic number is the number of protons in an atom of an element. This number is unique for each element, so it seems like an obvious way to organize the elements. (Mendeleev used atomic mass instead of atomic number because protons had not yet been discovered when he made his table.) In the modern table, atomic number increases from left to right across each period. It also increases from top to bottom within each group. How is this like Mendeleev's table?

Reading the Table

Besides atomic number, the periodic table includes each element's chemical symbol and class. Some tables include other information as well.

- The chemical symbol consists of one or two letters that come from the chemical's name in English or another language. The first letter is always written in upper case. The second letter, if there is one, is always written in lower case. For example, the symbol for lead is Pb. It comes from the Latin word *plumbum*, which means "lead." Find lead in **Figure 6.3**. What is its atomic number? You can access videos about lead and other elements in the modern periodic table at this URL: <http://www.periodicvideos.com/index.htm> .
- The classes of elements are metals, metalloids, and nonmetals. They are color-coded in the table. Blue stands for metals, orange for metalloids, and green for nonmetals. You can read about each of these three classes of elements later in the chapter, in the lesson "Classes of Elements."

Periods

Rows of the modern table are called periods, as they are in Mendeleev's table. From left to right across a period, each element has one more proton than the element before it. In each period, elements change from metals on the left side of the table, to metalloids, and then to nonmetals on the right. **Figure 6.4** shows this for period 4.

Some periods in the modern periodic table are longer than others. For example, period 1 contains only two elements. Periods 6 and 7, in contrast, are so long that some of their elements are placed below the main part of the table. They

The modern periodic table of elements is shown below, color-coded by groups: Metals (blue), Metalloids (orange), and Nonmetals (green). The table includes element symbols, names, atomic numbers, and atomic masses. It is organized into periods (rows) and groups (columns).

1 1A 1 H 1.00784 HYDROGEN	2 2A 3 Li 6.941 LITHIUM	4 2A 4 Be 9.0122 BERYLLIUM											13 3A 5 B 10.811 BORON	14 4A 6 C 12.011 CARBON	15 5A 7 N 14.007 NITROGEN	16 6A 8 O 15.999 OXYGEN	17 7A 9 F 18.998 FLUORINE	18 8A 10 Ne 20.180 NEON
11 3B 11 Na 22.990 SODIUM	12 4B 12 Mg 24.305 MAGNESIUM	3 4B 21 Sc 44.956 SCANDIUM	4 4B 22 Ti 47.88 TITANIUM	5 5B 23 V 50.942 VANADIUM	6 6B 24 Cr 51.996 CHROMIUM	7 7B 25 Mn 54.938 MANGANESE	8 8B 26 Fe 55.845 IRON	9 8B 27 Co 58.933 COBALT	10 8B 28 Ni 58.693 NICKEL	11 1B 29 Cu 63.546 COPPER	12 2B 30 Zn 65.38 ZINC	13 3A 31 Al 26.982 ALUMINUM	14 4A 32 Si 28.086 SILICON	15 5A 33 P 30.974 PHOSPHORUS	16 6A 34 S 32.06 SULFUR	17 7A 35 Cl 35.453 CHLORINE	18 8A 36 Ar 39.948 ARGON	
19 1B 37 K 39.098 POTASSIUM	20 2B 38 Ca 40.078 CALCIUM	39 10 39 Y 88.906 YTTRIUM	40 4B 40 Zr 91.224 ZIRCONIUM	41 5B 41 Nb 92.906 NIOBIUM	42 6B 42 Mo 95.94 MOLYBDENUM	43 7B 43 Tc 98.906 TECHNETIUM	44 8B 44 Ru 101.07 RHODIUM	45 8B 45 Rh 102.905 RHODIUM	46 8B 46 Pd 106.42 PALLADIUM	47 1B 47 Ag 107.868 SILVER	48 2B 48 Cd 112.411 CADMIUM	49 3A 49 In 114.818 INDIUM	50 4A 50 Sn 118.710 TIN	51 5A 51 Sb 121.760 ANTIMONY	52 6A 52 Te 127.60 TELLURIUM	53 7A 53 I 126.905 IODINE	54 8A 54 Xe 131.29 XENON	
55 1B 55 Cs 132.905 CESIUM	56 2B 56 Ba 137.327 BARIUM	57-71 10 57-71 LANTHANIDES	72 4B 72 Hf 178.49 HAFNIUM	73 5B 73 Ta 180.95 TANTALUM	74 6B 74 W 183.84 TUNGSTEN	75 7B 75 Re 186.207 RHENIUM	76 8B 76 Os 190.23 OSMIUM	77 8B 77 Ir 192.22 IRIDIUM	78 8B 78 Pt 195.084 PLATINUM	79 1B 79 Au 196.967 GOLD	80 2B 80 Hg 200.59 MERCURY	81 3A 81 Tl 204.384 THALLIUM	82 4A 82 Pb 207.2 LEAD	83 5A 83 Bi 208.980 BISMUTH	84 6A 84 Po 209 POLONIUM	85 7A 85 At 209 ASTATINE	86 8A 86 Rn 222 RADON	
87 1B 87 Fr 223 FRANCIUM	88 2B 88 Ra 226 RADIUM	89-103 10 89-103 ACTINIDES	104 4B 104 Rf 261 RUTHERFORDIUM	105 5B 105 Db 262 DUBNIUM	106 6B 106 Sg 263 SEABORGIUM	107 7B 107 Bh 264 BOHRIUM	108 8B 108 Hs 265 HASSIUM	109 8B 109 Mt 266 MEITNERIUM	110 8B 110 Ds 271 DARMSTADTIUM	111 1B 111 Rg 272 ROSGENIUM	112 2B 112 Cn 285 COPECNICIUM	113 3A 113 Uut 288 UNUNTRIUM	114 4A 114 Uuq 289 UNUNQUADIUM	115 5A 115 Uup 288 UNUNPENTIUM	116 6A 116 Uuh 289 UNUNHEXIUM	117 7A 117 Uus 289 UNUNSEPTIUM	118 8A 118 Uuo 289 UNUNOCTIUM	
LANTHANIDES		57 10 57 La 138.905 LANTHANUM	58 10 58 Ce 140.12 CELIUM	59 10 59 Pr 140.908 PRASEODYMIUM	60 10 60 Nd 144.242 NEODYMIUM	61 10 61 Pm 144.913 PROMETHIUM	62 10 62 Sm 150.362 SAMARIUM	63 10 63 Eu 151.964 EUROPIUM	64 10 64 Gd 157.253 GADOLINIUM	65 10 65 Tb 158.925 TERBIUM	66 10 66 Dy 162.505 DYSPROSIUM	67 10 67 Ho 164.930 HOLMIUM	68 10 68 Er 167.259 ERBIUM	69 10 69 Tm 168.934 THULIUM	70 10 70 Yb 173.043 YTTERIUM	71 10 71 Lu 174.967 LUTETIUM		
ACTINIDES		89 10 89 Ac 227 ACTINIUM	90 10 90 Th 232.038 THORIUM	91 10 91 Pa 231.036 PROTACTINIUM	92 10 92 U 238.029 URANIUM	93 10 93 Np 237.048 NEPTUNIUM	94 10 94 Pu 244.064 PLUTONIUM	95 10 95 Am 243.061 AMERICIUM	96 10 96 Cm 247.070 CURIUM	97 10 97 Bk 247.070 BERKELIUM	98 10 98 Cf 251.080 CALIFORNIUM	99 10 99 Es 252.083 EINSTEINIUM	100 10 100 Fm 257.085 FERMIUM	101 10 101 Md 258.108 MENDELEVIUM	102 10 102 No 259.108 NOBELIUM	103 10 103 Lr 260.105 LAWRENCIUM		

FIGURE 6.3

The modern periodic table of the elements is a lot like Mendeleev's table. But the modern table is based on atomic number instead of atomic mass. It also has more than 110 elements. Mendeleev's table only had about 65 elements.

are the elements starting with lanthanum (La) in period 6 and actinium (Ac) in period 7. Some elements in period 7 have not yet been named. They are represented by temporary symbols, such as Uub.

Groups

Columns of the modern table are called groups, as they are in Mendeleev's table. However, the modern table has many more groups — 18 to be exact. Elements in the same group have similar properties. For example, all elements in group 18 are colorless, odorless gases. You can read about the different groups of elements in this chapter's lesson on "Groups of Elements."

Lesson Summary

- Mendeleev developed the first periodic table of the elements in 1869. He organized the elements by increasing atomic mass. He used his table to predict unknown elements. These were later discovered.
- The modern periodic table is based on atomic number. Elements in each period go from metals on the left to

19 K 39.098 POTASSIUM	20 Ca 40.078 CALCIUM	21 Sc 44.956 SCANDIUM	22 Ti 47.867 TITANIUM	23 V 50.942 VANADIUM	24 Cr 51.996 CHROMIUM	25 Mn 54.938 MANGANESE	26 Fe 55.845 IRON	27 Co 58.933 COBALT	28 Ni 58.693 NICKEL	29 Cu 63.546 COPPER	30 Zn 65.392 ZINC	31 Ga 69.723 GALLIUM	32 Ge 72.630 GERMANIUM	33 As 74.922 ARSENIC	34 Se 78.963 SELENIUM	35 Br 79.904 BROMINE	36 Kr 83.801 KRYPTON
--------------------------------	-------------------------------	--------------------------------	--------------------------------	-------------------------------	--------------------------------	---------------------------------	----------------------------	------------------------------	------------------------------	------------------------------	----------------------------	-------------------------------	---------------------------------	-------------------------------	--------------------------------	-------------------------------	-------------------------------

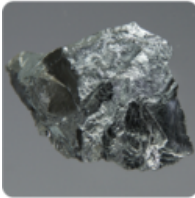

24
Cr
51.996
CHROMIUM

Chromium (Cr) is a shiny, silver-colored metal. It is added to steel to make it harder.

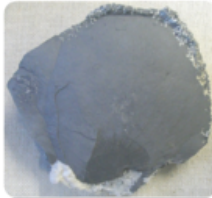

33
As
74.922
ARSENIC

Arsenic (As) is a poisonous metalloid. It is used in very small amounts in cell phones and other electronic products.



36
Kr
83.801
KRYPTON

Krypton (Kr) is a gaseous nonmetal. It is used in fluorescent lights.

FIGURE 6.4

Like other periods, period 4 changes from metals on the left to metalloids and then nonmetals on the right.

metalloids and then nonmetals on the right. Within groups, elements have similar properties.

Lesson Review Questions

Recall

1. How did Mendeleev organize the elements?
2. How does the modern periodic table differ from Mendeleev's table?
3. What is a period in the periodic table?
4. What is a group in the periodic table?

Apply Concepts

5. An unknown element has an atomic number of 44. Identify the element's symbol and the symbols of two other elements that have similar properties.

Think Critically

6. Mendeleev's table and the modern periodic table organize the elements based on different information, yet most elements are in the same order in both tables. Explain why.

Points to Consider

Elements are classified as metals, metalloids, or nonmetals.

- Do you know some examples of metals?
- How do you think metals might differ from the other two classes of elements?

6.2 Classes of Elements

Lesson Objectives

- Identify properties of metals.
- List properties of nonmetals.
- Describe metalloids.
- Relate valence electrons to reactivity of elements by class.

Vocabulary

- metal
- metalloid
- nonmetal
- valence electron

Introduction

Elements in different groups are lumped together in one of three classes, depending on their properties. The classes are metals, nonmetals, and metalloids. Knowing the class of an element lets you predict many of its properties. The video at the URL below is a good introduction to the classes.

<http://www.youtube.com/watch?v=ZuQmionhkGU> (2:04)

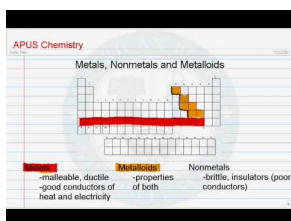

MEDIA

Click image to the left for more content.

Metals

Metals are elements that are good conductors of electricity. They are the largest of the three classes of elements. In fact, most elements are metals. Look back at the modern periodic table (**Figure 6.3**) in this chapter's lesson "How Elements Are Organized." Find the metals in the table. They are all the elements that are color-coded blue. Examples include sodium (Na), silver (Ag), and zinc (Zn).



Most metals are shiny. That's because they reflect a lot of light. This tray is made mainly of the metal silver (Ag).



Most metals are ductile. This means they can be pulled into long thin shapes, like these wires made of the metal copper (Cu).

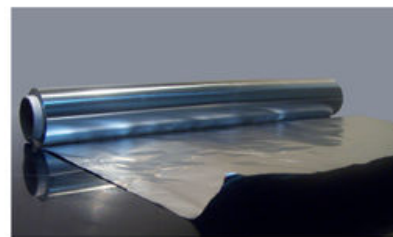

Most metals are malleable. This means they can be formed into thin sheets without breaking, like this foil made of the metal aluminum (Al).

FIGURE 6.5

The three properties described here characterize most metals.

Metals have relatively high melting points, so almost all are solids at room temperature. The only exception is mercury (Hg), which is a liquid. Most metals are also good conductors of heat. That's why they are used for cooking pots and stovetops. Metals have other characteristic properties as well. Most are shiny, ductile, and malleable. These properties are illustrated in **Figure 6.5**. You can dig deeper into the properties of metals at this URL: http://www.bc.co.uk/schools/gcsebitesize/science/add_gateway/periodictable/metalsrev1.shtml .

Nonmetals

Nonmetals are elements that do not conduct electricity. They are the second largest class of elements. Find the nonmetals in **Figure 6.3**. They are all the elements on the right side of the table that are color-coded green. Examples of nonmetals include helium (He), carbon (C), and oxygen (O).

Nonmetals generally have properties that are the opposite of those of metals. They also tend to vary more in their properties than metals do. For example, nonmetals have relatively low boiling points, so many of them are gases at room temperature. But several nonmetals are solids, including carbon and phosphorus (P). One nonmetal, bromine (Br), is a liquid at room temperature.

Generally, nonmetals are also poor conductors of heat. In fact, they may be used for insulation. For example, the down filling in a down jacket is mostly air, which consists mainly of nitrogen (N) and oxygen (O). These nonmetal gases are poor conductors of heat, so they keep body heat in and cold air out. Solid nonmetals are dull rather than shiny. They are also brittle rather than ductile or malleable. You can see examples of solid nonmetals in **Figure 6.6**. You can learn more about specific nonmetals with the interactive table at this URL: <http://library.thinkquest.org/3659/pertable/nonmetal.html> .



These yellow piles of powder are sulfur (S), a nonmetal. Sulfur in rocks has been ground up to produce a powder. The powder has been heaped on a dock for shipment.

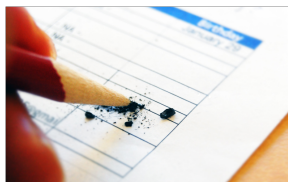

The "lead" in this pencil is actually graphite, a form of the nonmetal carbon (C). Graphite is brittle. It breaks easily if you put too much pressure on it.



These match heads are coated with the nonmetal phosphorus (P). Phosphorus is not malleable. If you tried to pound it flat, it would crumble into a powder.

FIGURE 6.6

Unlike metals, solid nonmetals are dull and brittle.

Metalloids

Metalloids are elements that fall between metals and nonmetals in the periodic table. Just seven elements are metalloids, so they are the smallest class of elements. In **Figure 6.3**, they are color-coded orange. Examples of metalloids include boron (B), silicon (Si), and germanium (Ge).

Metalloids have some properties of metals and some properties of nonmetals. For example, many metalloids can conduct electricity but only at certain temperatures. These metalloids are called semiconductors. Silicon is an example. It is used in computer chips. It is also the most common metalloid on Earth. It is shiny like a metal but brittle like a nonmetal. You see a sample of silicon in **Figure 6.7**. The figure also shows other examples of metalloids. You can learn more about the properties of metalloids at this URL: <http://library.thinkquest.org/3659/pertable/metalloid.html> .

Classes of Elements and Electrons

From left to right across the periodic table, each element has one more proton than the element to its left. Because atoms are always electrically neutral, for each added proton, one electron is also added. Electrons are added first to the lowest energy level possible until that level is full. Only then are electrons added to the next higher energy level.

Electrons by Class

The increase in electrons across the periodic table explains why elements go from metals to metalloids and then to nonmetals from left to right across the table. Look at period 2 in **Figure 6.8** as an example. Lithium (Li) is a metal, boron (B) a metalloid, and fluorine (F) and neon (Ne) are nonmetals. The inner energy level is full for all four elements. This level has just one orbital and can hold a maximum of two electrons. The outer energy level is a different story. This level has four orbitals and can hold a maximum of eight electrons. Lithium has just one electron in this level, boron has three, fluorine has seven, and neon has eight.

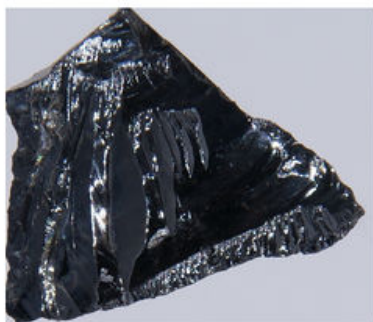

Silicon (Si) is a metal that can conduct electricity but not as well as a metal. It is shiny but brittle. It chips easily, like glass.



Antimony (Sb) is a metalloid that is shiny like a metal but brittle like a nonmetal.



Boron (B) is a metalloid that is somewhat shiny. It also conducts electricity like a metal. However, it is brittle like a nonmetal.

FIGURE 6.7

Metalloids share properties with both metals and nonmetals.

Valence Electrons and Reactivity



The electrons in the outer energy level of an atom are called **valence electrons**. It is valence electrons that are potentially involved in chemical reactions. The number of valence electrons determines an element's reactivity, or how likely the element is to react with other elements. The number of valence electrons also determines whether the element can conduct electric current. That's because electric current is the flow of electrons. **Table 6.1** shows how these properties vary in elements from each class.

- Metals such as lithium have an outer energy level that is almost empty. They "want" to give up their few valence electrons so they will have a full outer energy level. As a result, metals are very reactive and good conductors of electricity.
- Metalloids such as boron have an outer energy level that is about half full. These elements need to gain or lose too many electrons for a full outer energy level to come about easily. As a result, these elements are not very reactive. They may be able to conduct electricity but not very well.
- Some nonmetals, such as bromine, have an outer energy level that is almost full. They "want" to gain electrons so they will have a full outer energy level. As a result, these nonmetals are very reactive. Because they only accept electrons and do not give them up, they do not conduct electricity.
- Other nonmetals, such as neon, have a completely full outer energy level. Their electrons are already in the most stable arrangement possible. They are unreactive and do not conduct electricity.

TABLE 6.1: These examples show the relative reactivity of elements in the three classes.

Element	Description
---------	-------------

TABLE 6.1: (continued)

Element	Description
Lithium 	Lithium (Li) is a highly reactive metal. It has just one electron in its outer energy level. Lithium reacts explosively with water (see picture). It can react with moisture on skin and cause serious burns.
Boron 	Boron (B) is a metalloid. It has three valence electrons and is less reactive than lithium. Boron compounds dissolved in water form boric acid. Dilute boric acid is weak enough to use as eye wash.
Bromine	Bromine (Br) is an extremely reactive nonmetal. In fact, reactions with fluorine are often explosive, as you can see in the URL below. http://www.youtube.com/watch?v=vtWp45Eewtw
Neon 	Neon (Ne) is a nonmetal gas with a completely filled outer energy level. This makes it unreactive, so it doesn't combine with other elements. Neon is used for lighted signs like this one. You can learn why neon gives off light at this link: http://www.scientificamerican.com/article.cfm?id=how-do-neon-lights-work

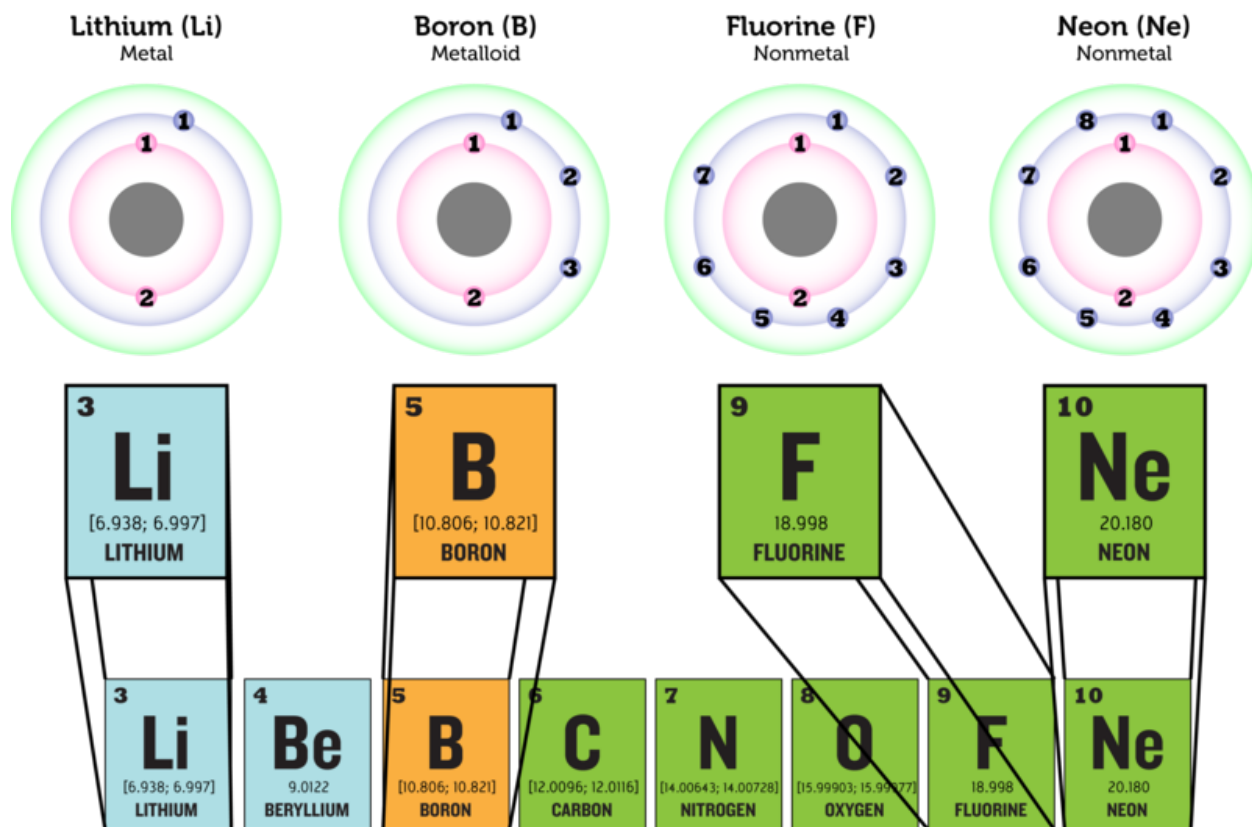

FIGURE 6.8

The number of electrons increases from left to right across each period in the periodic table. In period 2, lithium (Li) has the fewest electrons and neon (Ne) has the most. How do the numbers of electrons in their outer energy levels compare?

Lesson Summary

- Metals are elements that are good conductors of electricity. They are the largest class of elements. Many metals are shiny, ductile, and malleable. They are also good conductors of heat. Almost all metals are solids at room temperature.
- Nonmetals are elements that do not conduct electricity. They are the second largest class of elements. Nonmetals are also poor conductors of heat. The majority of nonmetals are gases. Solid nonmetals are dull and brittle.
- Metalloids are elements that have properties of both metals and nonmetals. Some can conduct electricity but only at certain temperatures. They may be shiny but brittle. All metalloids are solids at room temperature.
- Atoms of elements in different classes vary in their number of valence electrons. This explains their differences in reactivity and conductivity.

Lesson Review Questions

Recall

1. What are metals? Name one example.
2. Define nonmetal, and give an example.
3. State one way that metalloids may be like metals and one way they may be like nonmetals.
4. What are valence electrons?

Apply Concepts

5. A mystery element is a dull, gray solid. It is very reactive with other elements. Classify the mystery element as a metal, nonmetal, or metalloid. Explain your answer.

Think Critically

6. Create a Venn diagram for metals, metalloids, and nonmetals. The diagram should show which properties are different and which, if any, are shared among the three groups of elements.
7. Relate number of valence electrons to reactivity of classes of elements.

Points to Consider

The number of valence electrons increases from left to right across each period of the periodic table. By the end of the period, the outer energy level is full. Moving on to the next period of the table, electrons are added to the next higher energy level. This happens in each row of the periodic table.

- How do you think the number of valence electrons compares in elements within the same column (group) of the periodic table?
- How might this be reflected in the properties of elements within a group?

6.3 Groups of Elements

Lesson Objectives

- Identify hydrogen and alkali metals.
- Describe alkaline Earth metals.
- List properties of transition metals.
- Identify groups containing metalloids.
- Give properties of halogens.
- Describe noble gases.

Vocabulary

- alkali metal
- alkaline Earth metal
- halogen
- noble gas
- transition metal

Introduction

Elements in the same column, or group, of the periodic table have the same number of valence electrons in their outer energy level. This gives them many similar properties. The rest of this chapter describes properties of the different groups of elements. You can watch a video about the groups at this link: <http://www.khanacademy.org/video/groups-of-the-periodic-table?playlist=Chemistry> .

Group 1: Hydrogen and Alkali Metals

All the elements in group 1 have just one valence electron, so they are highly reactive. Group 1 is shown in **Figure 6.9**. At the top of this group is hydrogen (H), which is a very reactive, gaseous nonmetal. It is the most common element in the universe.

All the other elements in group 1 are **alkali metals**. They are the most reactive of all metals, and along with the elements in group 17, the most reactive elements. Because alkali metals are so reactive, they are only found in nature combined with other elements. The alkali metals are soft. Most are soft enough to cut with a knife. They are also low in density. Some of them even float on water. All are solids at room temperature. You can see a video demonstrating the reactivity of alkali metals with water at this URL: <http://www.youtube.com/watch?v=uixxJtJPVXk> (2:22).



MEDIA

Click image to the left for more content.

Sodium (Group 1)



1	H 1.00784-1.00811 HYDROGEN
3	Li (6.938; 6.997) LITHIUM
11	Na 22.990 SODIUM
19	K 39.098 POTASSIUM
37	Rb 85.468 RUBIDIUM
55	Cs 132.905 CESIUM
87	Fr 223.020 FRANCIUM

Sodium (Na) is an alkali metal. It is so reactive that it doesn't occur alone in nature. It is commonly found combined with chlorine (Cl) as sodium chloride (NaCl), which is table salt.

FIGURE 6.9

In group 1 of the periodic table, all the elements except hydrogen (H) are alkali metals.

Group 2: Alkaline Earth Metals

The **alkaline Earth metals** include all the elements in group 2 (see **Figure 6.10**). These metals have just two valence electrons, so they are very reactive, although not quite as reactive as the alkali metals. In nature, they are always found combined with other elements. Alkaline Earth metals are silvery grey in color. They are harder and denser than the alkali metals. All are solids at room temperature.

Groups 3-12: Transition Metals

Groups 3–12 of the periodic table contain **transition metals** (see **Figure 6.11**). Transition metals have more valence electrons and are less reactive than metals in the first two metal groups. The transition metals are shiny. Many are silver colored. They tend to be very hard, with high melting and boiling points. All except mercury (Hg) are solids at room temperature.

Transition metals include the elements that are placed below the periodic table. Those that follow lanthanum (La) are called lanthanides. They are all shiny, relatively reactive metals. Those that follow Actinium (Ac) are called actinides. They are all radioactive metals. This means they are unstable. They break down into different, more stable elements. You can read more about radioactive elements in the chapter *Nuclear Chemistry*. Many of the actinides do not occur in nature but are made in laboratories.

Calcium (Group 2)

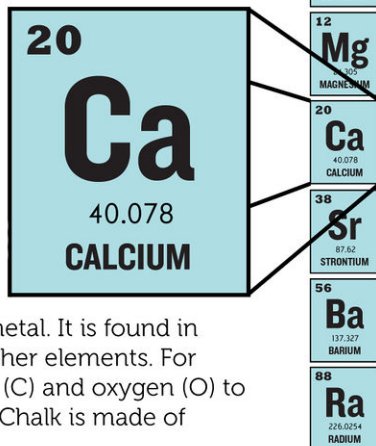

Calcium (Ca) is an alkaline Earth metal. It is found in nature only in compounds with other elements. For example, it combines with carbon (C) and oxygen (O) to form calcium carbonate (CaCO₃). Chalk is made of calcium carbonate.

FIGURE 6.10

The alkaline Earth metals make up group 2 of the periodic table.

Groups 3-12: Transition Metals

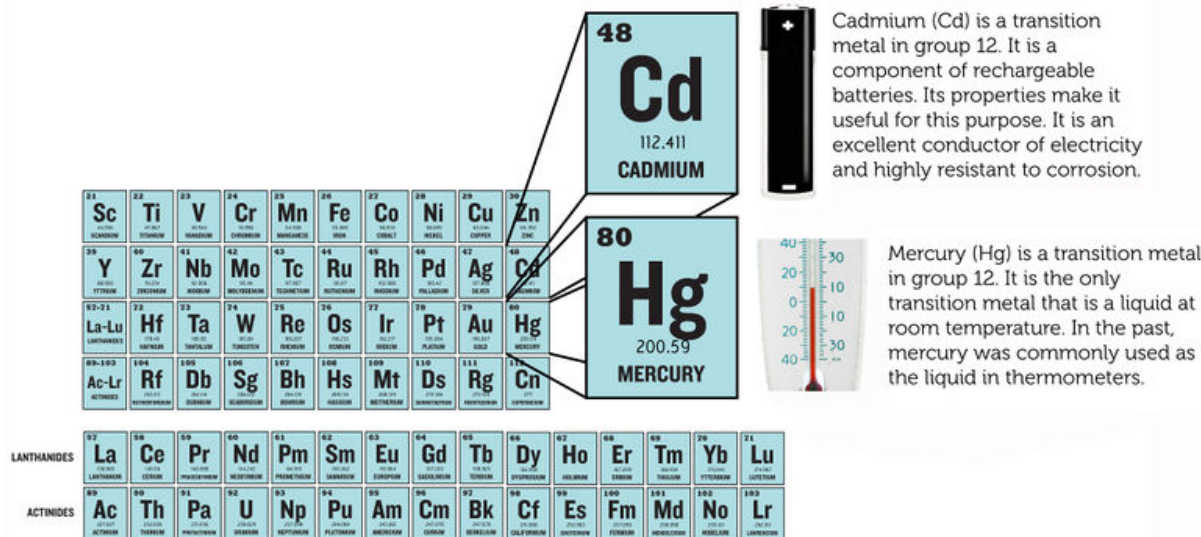

FIGURE 6.11

All the elements in groups 3–12 are transition metals.

Groups 13-16: Groups Containing Metalloids

Groups 13–16 each contain one or more metalloids. These groups are shown in **Figure 6.12**.

- Group 13 is called the boron group. The only metalloid in this group is boron (B). The other four elements are metals. All group 13 elements have three valence electrons and are fairly reactive. All are solids at room

Groups 13-16: Metalloids

Aluminum (Group 13)

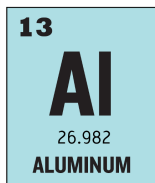

Aluminum (Al) is a shiny, low-density metal in group 13. It is durable, ductile, and malleable. Aluminum's properties make it a good choice for objects such as beverage cans, lawn furniture, and siding on homes.

Tin (Group 14)

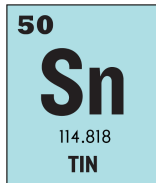

Tin (Sn) is a shiny, silver-colored metal in Group 14. The tin man in *The Wizard of Oz* was afraid of "rusting," but tin doesn't really rust (only iron rusts). In fact, tin is not very reactive with oxygen at all. That's one reason why it is used in food cans and for roofs.

Nitrogen (Group 15)

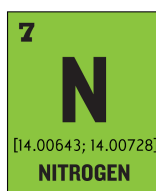
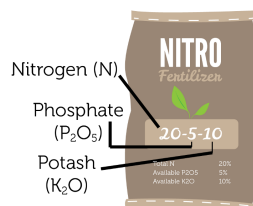

Nitrogen (N) is a gaseous nonmetal in group 15. It makes up 78% of Earth's atmosphere. Plants need nitrogen but are unable to use gaseous nitrogen in the air. Fertilizers supply nitrogen in a form plants can use.

Selenium (Group 16)

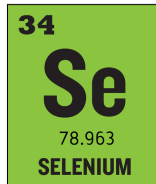

Selenium (Se) is a solid nonmetal in group 16. People need small amounts of selenium for good health. Nuts and fish are good food sources of selenium.

5 B [10.806; 10.821] BORON	6 C [12.0096; 12.0116] CARBON	7 N [14.00643; 14.00728] NITROGEN	8 O [15.99903; 15.99977] OXYGEN
13 Al 26.982 ALUMINUM	14 Si [28.084; 28.086] SILICON	15 P 30.974 PHOSPHORUS	16 S [32.059; 32.076] SULFUR
31 Ga 69.723 GALLIUM	32 Ge 69.723 GERMANIUM	33 As 74.922 ARSENIC	34 Se 78.963 SELENIUM
49 In 114.818 INDIUM	50 Sn 114.818 TIN	51 Sb 121.760 ANTIMONY	52 Te 127.603 TELLURIUM
81 Tl [204.382; 204.385] THALLIUM	82 Pb 204.383 LEAD	83 Bi 208.980 BISMUTH	84 Po 208.982 POLONIUM

FIGURE 6.12

These groups each contain one or more metalloids.

temperature.

- Group 14 is called the carbon group. Carbon (C) is a nonmetal. The next two elements are metalloids, and the final two are metals. All the elements in the carbon group have four valence electrons. They are not very reactive. All are solids at room temperature.
- Group 15 is called the nitrogen group. The first two elements in this group are nonmetals. These are followed by two metalloids and one metal. All the elements in the nitrogen group have five valence electrons, but they vary in their reactivity. Nitrogen (N) is not reactive at all. Phosphorus (P), in contrast, is quite reactive. In fact, it is found naturally only in combination with other substances. Nitrogen is a gas at room temperature. The other group 15 elements are solids.
- Group 16 is called the oxygen group. The first three elements in this group are nonmetals. They are followed by one metalloid and one metal. All the elements in the oxygen group have six valence electrons, and all are

reactive. Oxygen (O), for example, readily reacts with metals to form compounds such as rust. Oxygen is a gas at room temperature. The other four elements in group 16 are solids.

Group 17: Halogens

Elements in group 17 are called **halogens** (see **Figure 6.13**). They are highly reactive nonmetals with seven valence electrons. The halogens react violently with alkali metals, which have one valence electron. The two elements combine to form a salt. For example, the halogen chlorine (Cl) and the alkali metal sodium (Na) react to form table salt, or sodium chloride (NaCl). The halogen group includes gases, liquids, and solids. For example, chlorine is a gas at room temperature, bromine (Br) is a liquid, and iodine (I) is a solid. You can watch a video demonstrating the reactivity of halogens at this URL: http://www.youtube.com/watch?v=mY7o28-l_WU&feature=related .

Group 18: Noble Gases

Group 18 elements are nonmetals called **noble gases** (see **Figure 6.14**). They are all colorless, odorless gases. Their outer energy level is also full, so they are the least reactive elements. In nature, they seldom combine with other substances. For a short video about the noble gases and their properties, go to this URL: <http://www.youtube.com/watch?v=QLrofyj6a2s> (1:17).

Lesson Summary

- Group 1 of the periodic table consists of hydrogen and the alkali metals. Hydrogen is a very reactive nonmetal. The alkali metals are the most reactive metals.
- Group 2 consists of the alkaline Earth metals. They are very reactive but less so than the alkali metals.
- Groups 3–12 contain transition metals. They are less reactive than metals in groups 1 and 2.
- Groups 13–16 each contain at least one metalloid. They also contain metals and/or nonmetals. Elements in these groups vary in reactivity and other properties.
- Group 17 contains halogens. They are highly reactive nonmetals.
- Group 18 consists of noble gases. They are unreactive and rarely combine with other elements.

Lesson Review Questions

Recall

1. What are alkali metals? What is one example?
2. Identify an alkaline Earth metal. How reactive is it?
3. Which element is the only transition metal that is a liquid at room temperature?
4. In which groups of the periodic table would you find metalloids?
5. State why halogens are highly reactive.
6. Describe noble gases.

Group 17: Halogens

Fluorine (Group 17)

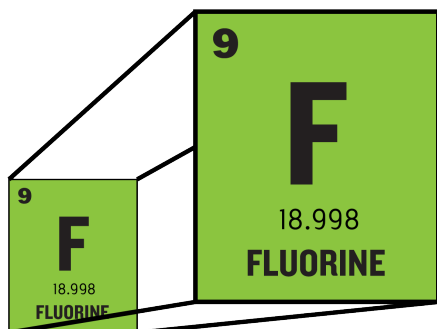

Fluorine (F) is a gaseous halogen. Evidence shows that fluorine helps prevent tooth decay. That's why it is added to toothpaste in the form of sodium fluoride. You can learn how it protects teeth at: http://www.animated-teeth.com/tooth_decay/t4_tooth_decay_fluoride.htm

Bromine (Group 17)

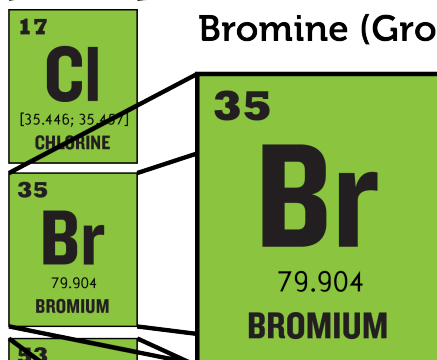

Bromine (Br) is the only liquid halogen. In tablet form, bromine is used to purify water in swimming pools and hot tubs. It reacts with bacteria and other germs and renders them harmless.

Iodine (Group 17)

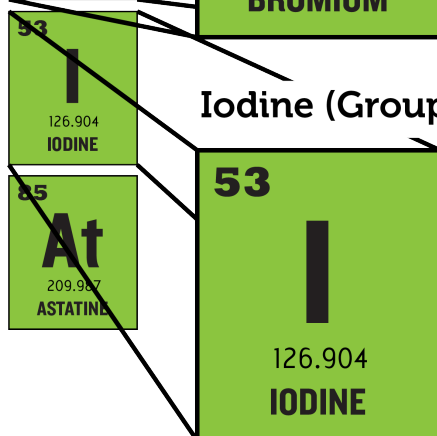

Iodine (I) is a solid halogen. It is added to alcohol and used as an antiseptic. It reacts with germs on cuts and wounds. Small amounts of iodine are also needed for good health. In the U.S., iodine is added to table salt to prevent iodine deficiencies. Does the salt you use contain iodine?

FIGURE 6.13

Group 17 consists of the nonmetals called halogens.

Apply Concepts

- Assume you have a sample of an unknown element. At room temperature, it is a soft solid. You cut a small piece from the sample with a knife and drop the piece into a container of water. It bursts into flames. Which group of the periodic table does the unknown element belong in?

Group 18: Noble Gases

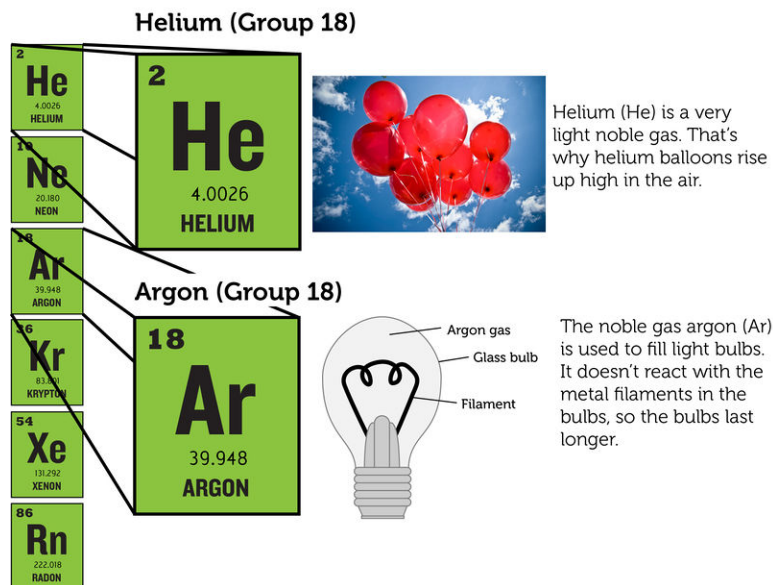

FIGURE 6.14

Noble gases include helium and argon.

Think Critically

- Both hydrogen (H) and helium (He) are gaseous nonmetals. Why are they placed on opposite sides of the periodic table?

Points to Consider

Reactive elements combine easily with other elements. This explains why they usually exist in nature in compounds rather than in pure form.

- How do you think elements join together to form compounds?
- Do you think this might vary from one group of elements to another?

For **Table 6.1**,

- Lithium: User:Chemicalinterest/Wikimedia Commons. http://commons.wikimedia.org/wiki/File:Lithium_burning.JPG . Public Domain.
- Boron: Christopher Auyeung. CC BY-NC 3.0. CK-12 Foundation.
- Neon: Andy Wright. <http://www.flickr.com/photos/rightee/4356950/> . CC BY 2.0.

6.4 References

1. . <http://commons.wikimedia.org/wiki/File:DIMendeleevCab.jpg> . Public Domain
2. Dmitri Mendeleev. http://commons.wikimedia.org/wiki/File:Mendelejevs_periodiska_system_1871.png . Public Domain
3. Christopher Auyeung. [CK-12 Foundation](#) . CC BY-NC 3.0
4. Chromium and krypton: User:Jurii/Wikimedia Commons; Arsenic: Aram Dulyan (Wikimedia: Aramgutang). Chromium: <http://commons.wikimedia.org/wiki/File:Chromium.jpg>; Arsenic: http://commons.wikimedia.org/wiki/File:Native_arsenic.jpg; Krypton: <http://commons.wikimedia.org/wiki/File:Krypton-glow.jpg> . Chromium and krypton: CC-BY 3.0; Arsenic: Public Domain
5. Silver tray: The Living Room; Copper wire: Flickr:Flavio~; Aluminum foil: User:MdeVicente/Wikimedia Commons. Silver tray: <http://www.flickr.com/photos/thelivingroominkenmore/4546677601/>; Copper wire: <http://www.flickr.com/photos/37873897@N06/6154424083/>; Aluminum foil: <http://commons.wikimedia.org/wiki/File:Aluminio.jpg> . Silver tray: CC BY 2.0; Copper wire: CC BY 2.0; Aluminum foil: Public Domain
6. Sulfur: Ed Uthman; Pencil: Robert Lopez; Matches: Charles Knowles. Sulfur: <http://www.flickr.com/photos/euthman/9183618186/>; Pencil: [CK-12 Foundation](#); Matches: <http://www.flickr.com/photos/theknowledgallery/4536616288/> . Sulfur: CC BY 2.0; Pencil: CC BY-NC 3.0; Matches: CC BY 2.0
7. User: Jurii/Wikimedia Commons. Silicon: <http://commons.wikimedia.org/wiki/File:Silicon.jpg>; Antimony: <http://commons.wikimedia.org/wiki/File:Antimony-piece.jpg>; Boron: <http://commons.wikimedia.org/wiki/File:Bron.jpg> . CC BY 3.0
8. Christopher Auyeung. [CK-12 Foundation](#) . CC BY-NC 3.0
9. Salt: Dubravko Sorić (Flickr:SoraZG). http://commons.wikimedia.org/wiki/File:Salt_shaker_on_white_background.jpg . CC BY 2.0
10. Chalk: Steve A Johnson. <http://www.flickr.com/photos/artbystevejohnson/4618054549/> . CC BY 2.0
11. Battery: Robert Lopez; Thermometer: Flickr: dwstucke. Battery: [CK-12 Foundation](#); Thermometer: http://commons.wikimedia.org/wiki/File:Thermometer_-_by_Don.jpg . Battery: CC BY-NC 3.0; Thermometer: CC BY 2.0
12. Aluminum cans: MoneyBlogNewz; Tin man: JD Hancock; Fertilizer and Selenium bottle: Christopher Auyeung. Aluminum cans: <http://www.flickr.com/photos/moneyblognewz/5408772758/>; Tin man: <http://www.flickr.com/photos/jdhancock/4896517056/>; Fertilizer and Selenium bottle: [CK-12 Foundation](#) . Aluminum cans and Tin man: CC BY 2.0; Fertilizer and Selenium bottle: CC BY-NC 3.0
13. Christopher Auyeung. [CK-12 Foundation](#) . CC BY-NC 3.0
14. Balloon: LeAnn E. Crowe; Bulb: Christopher Auyeung. Balloon: <http://www.flickr.com/photos/technicolor76/3705507804/>; Bulb: [CK-12 Foundation](#) . Balloon: CC BY 2.0; Bulb: CC BY-NC 3.0

CHAPTER 7

Chemical Bonding

Chapter Outline

- 7.1 INTRODUCTION TO CHEMICAL BONDS
- 7.2 IONIC BONDS
- 7.3 COVALENT BONDS
- 7.4 METALLIC BONDS
- 7.5 REFERENCES



What do this lump of coal, diamond, and pencil "lead" all have in common? All three substances are forms of carbon. Are you surprised that one element can exist in forms that have such different properties? Do you know what explains it? The answer is chemical bonds. Carbon atoms chemically bond together in different ways to form these three substances. What are chemical bonds and how do they form? Read on to find out.

Coal: Image copyright SeDmi, 2013; Diamond: Image copyright AptTone, 2013; Pencil: Image copyright hxdbzxy, 2013. www.shutterstock.com. Used under licenses fr

7.1 Introduction to Chemical Bonds

Lesson Objectives

- Define chemical bond.
- List general properties of compounds.

Lesson Vocabulary

- chemical bond
- chemical formula

Introduction

There is an amazing diversity of matter in the universe, but there are only about 100 elements. How can this relatively small number of pure substances make up all kinds of matter? Elements can combine in many different ways. When they do, they form new substances called compounds. For a video introduction to compounds, go this URL: <http://www.youtube.com/watch?v=-HjMoTthEZO> (3:53).



MEDIA

Click image to the left for more content.

Chemical Bonding

Elements form compounds when they combine chemically. Their atoms join together to form molecules, crystals, or other structures. The atoms are held together by chemical bonds. A **chemical bond** is a force of attraction between atoms or ions. It occurs when atoms share or transfer valence electrons. Valence electrons are the electrons in the outer energy level of an atom. You can learn more about chemical bonds in this video: <http://www.youtube.com/watch?v=CGA8sRwqIFg> (13:21).

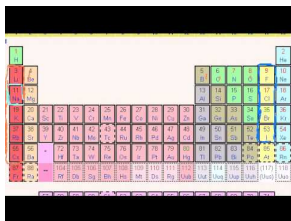

MEDIA

 Click image to the left for more content.

Look at the example of water in **Figure 7.1**. A water molecule consists of two atoms of hydrogen and one atom of oxygen. Each hydrogen atom has just one electron. The oxygen atom has six valence electrons. In a water molecule, two hydrogen atoms share their two electrons with the six valence electrons of one oxygen atom. By sharing electrons, each atom has electrons available to fill its sole or outer energy level. This gives it a more stable arrangement of electrons that takes less energy to maintain.

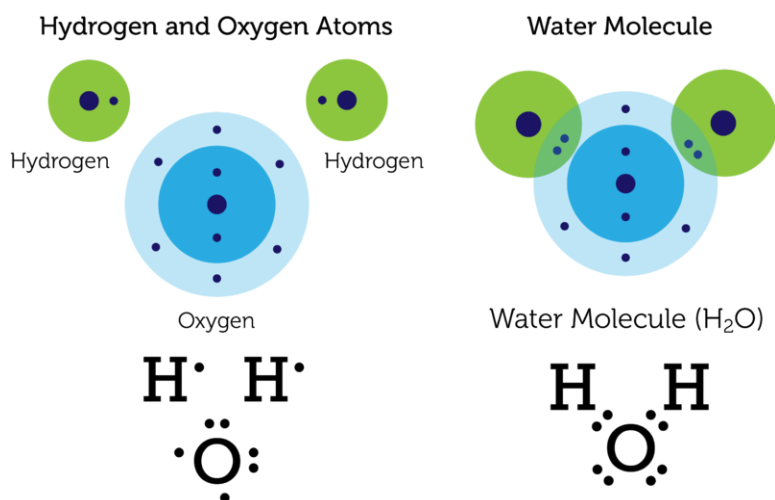

FIGURE 7.1

 These diagrams show the valence electrons of hydrogen and water atoms and a water molecule. The diagrams represent electrons with dots, so they are called electron dot diagrams.

Chemical Compounds

Water (H₂O) is an example of a chemical compound. Water molecules always consist of two atoms of hydrogen and one atom of oxygen. Like water, all other chemical compounds consist of a fixed ratio of elements. It doesn't matter how much or how little of a compound there is. It always has the same composition.

Chemical Formulas

Elements are represented by chemical symbols. Examples are H for hydrogen and O for oxygen. Compounds are represented by **chemical formulas**. You've already seen the chemical formula for water. It's H₂O. The subscript 2 after the H shows that there are two atoms of hydrogen in a molecule of water. The O for oxygen has no subscript. When there is just one atom of an element in a molecule, no subscript is used. **Table 7.1** shows some other examples of compounds and their chemical formulas.

TABLE 7.1: Examples of Chemical Compounds

Name of Compound	Electron Dot Diagram	Numbers of Atoms	Chemical Formula
------------------	----------------------	------------------	------------------

TABLE 7.1: (continued)

Name of Compound	Electron Dot Diagram	Numbers of Atoms	Chemical Formula
Hydrogen chloride	$\text{H}:\ddot{\text{Cl}}:$	H = 1 Cl = 1	HCl
Methane	$\begin{array}{c} \text{H} \\ \vdots \\ \text{H}:\text{C}:\text{H} \\ \vdots \\ \text{H} \end{array}$	C = 1 H = 4	CH ₄
Hydrogen peroxide	$\text{H}:\ddot{\text{O}}:\ddot{\text{O}}:\text{H}$	H = 2 O = 2	H ₂ O ₂
Carbon dioxide	$\ddot{\text{O}}::\text{C}::\ddot{\text{O}}$	C = 1 O = 2	CO ₂

Problem Solving

Problem: A molecule of ammonia consists of one atom of nitrogen (N) and three atoms of hydrogen (H). What is its chemical formula?

Solution: The chemical formula is NH₃.

You Try It!

Problem: A molecule of nitrogen dioxide consists of one atom of nitrogen (N) and two atoms of oxygen (O). What is its chemical formula?

Same Elements, Different Compounds

The same elements may combine in different ratios. If they do, they form different compounds. **Figure 7.2** shows some examples. Both water (H₂O) and hydrogen peroxide (H₂O₂) consist of hydrogen and oxygen. However, they have different ratios of the two elements. As a result, water and hydrogen peroxide are different compounds with different properties. If you've ever used hydrogen peroxide to disinfect a cut, then you know that it is very different from water! Both carbon dioxide (CO₂) and carbon monoxide (CO) consist of carbon and oxygen, but in different ratios. How do their properties differ?

Types of Compounds

There are different types of compounds. They differ in the nature of the bonds that hold their atoms together. The type of bonds in a compound determines many of its properties. Three types of bonds are ionic, covalent, and metallic bonds. You will read about these three types in later lessons. You can also learn more about them by watching this video: <http://www.youtube.com/watch?v=hEFeLYWTKX0> (7:18).



Water (H₂O)

Water is odorless and colorless. We drink it, bathe in it, and use it to wash our clothes. In fact, we can't live without it.



Hydrogen Peroxide (H₂O₂)

Hydrogen peroxide is also odorless and colorless. It's used as an antiseptic. It kills germs on cuts. It's also used as bleach. It removes color from hair.



Carbon Dioxide (CO₂)

Every time you exhale, you release carbon dioxide. It's an odorless, colorless gas. Carbon dioxide contributes to global climate change, but it isn't directly harmful to human health.



Carbon Monoxide (CO)

Carbon monoxide is produced when matter burns. It's an odorless, colorless gas that is very harmful to human health. In fact, it can kill people in minutes. You can't see or smell carbon monoxide. A carbon monoxide detector sounds an alarm if the level of the gas gets too high.

FIGURE 7.2

Different compounds may contain the same elements in different ratios. How does this affect their properties?

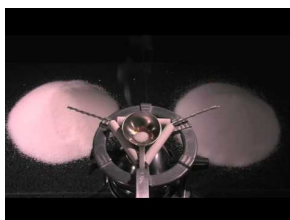

MEDIA

Click image to the left for more content.

Lesson Summary

- A chemical bond is a force of attraction between atoms. It occurs when atoms share or transfer electrons.
- A chemical compound is a new substance that forms when atoms of different elements form chemical bonds. A compound always consists of a fixed ratio of elements.

Lesson Review Questions

Recall

1. What is a chemical bond?
2. Define chemical compound.

Apply Concepts

3. Which atoms and how many of each make up a molecule of sulfur dioxide? Write the chemical formula for this compound.

Think Critically

4. Why does a molecule of water have a more stable arrangement of electrons than do individual hydrogen and oxygen atoms?
5. Explain how the ratio of elements in a compound is related to the compound's properties.

Points to Consider

In this lesson, you learned about chemical bonds in a water molecule. The bonds form between atoms of hydrogen and oxygen when they share electrons. This type of bond is an example of a covalent bond.

- What might be other ways that atoms can bond together?
- How might ions form bonds?

7.2 Ionic Bonds

Lesson Objectives

- Describe how ionic bonds form.
- List properties of ionic compounds.

Lesson Vocabulary

- ionic bond
- ionic compound

Introduction

All compounds form when atoms of different elements share or transfer electrons. In water, the atoms share electrons. In some other compounds, called **ionic compounds**, atoms transfer electrons. The electrons actually move from one atom to another. When atoms transfer electrons in this way, they become charged particles called ions. The ions are held together by ionic bonds.

Formation of Ionic Bonds

An **ionic bond** is the force of attraction that holds together positive and negative ions. It forms when atoms of a metallic element give up electrons to atoms of a nonmetallic element. **Figure 7.3** shows how this happens.

In row 1 of **Figure 7.3**, an atom of sodium donates an electron to an atom of chlorine (Cl).

- By losing an electron, the sodium atom becomes a sodium ion. It now has one less electron than protons, giving it a charge of +1. Positive ions such as sodium are given the same name as the element. The chemical symbol has a plus sign to distinguish the ion from an atom of the element. The symbol for a sodium ion is Na^+ .
- By gaining an electron, the chlorine atom becomes a chloride ion. It now has one more electron than protons, giving it a charge of -1. Negative ions are named by adding the suffix *-ide* to the first part of the element name. The symbol for chloride is Cl^- .

Sodium and chloride ions have equal but opposite charges. Opposites attract, so sodium and chloride ions attract each other. They cling together in a strong ionic bond. You can see this in row 2 of **Figure 7.3**. Brackets separate the ions in the diagram to show that the ions in the compound do not share electrons. You can see animations of sodium chloride forming at these URLs:

- <http://web.jjay.cuny.edu/~acarpi/NSC/salt.htm>

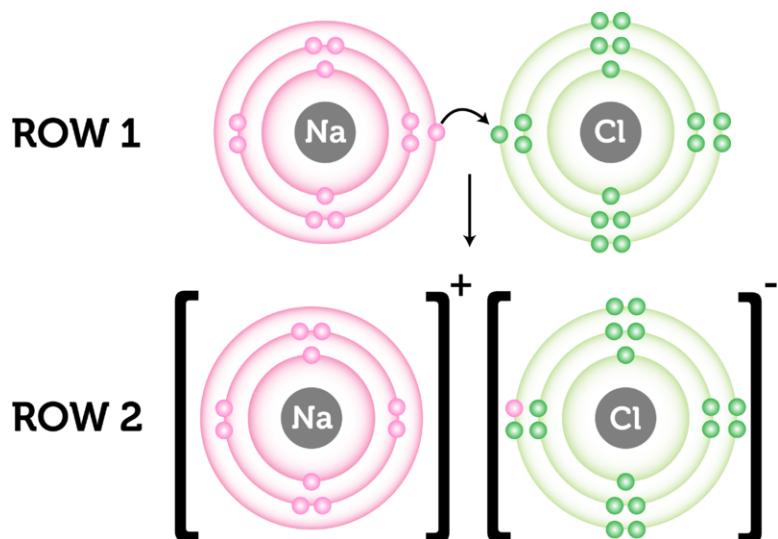
**FIGURE 7.3**

An ionic bond forms when the metal sodium gives up an electron to the non-metal chlorine.

- http://www.visionlearning.com/library/module_viewer.php?mid=55

Why Ionic Bonds Form

Ionic bonds form only between metals and nonmetals. Metals "want" to give up electrons, and nonmetals "want" to gain electrons. Find sodium (Na) in **Figure 7.4**. Sodium is an alkali metal in group 1. Like other group 1 elements, it has just one valence electron. If sodium loses that one electron, it will have a full outer energy level. Now find fluorine (F) in **Figure 7.4**. Fluorine is a halogen in group 17. It has seven valence electrons. If fluorine gains one electron, it will have a full outer energy level. After sodium gives up its valence electron to fluorine, both atoms have a more stable arrangement of electrons.

PERIODIC TABLE OF ELEMENTS

Sodium

Chlorine

FIGURE 7.4

Sodium and chlorine are on opposite sides of the periodic table. How is this related to their numbers of valence electrons?

Energy and Ionic Bonds

It takes energy to remove valence electrons from an atom. The force of attraction between the negative electrons and positive nucleus must be overcome. The amount of energy needed depends on the element. Less energy is needed to remove just one or a few electrons than many. This explains why sodium and other alkali metals form positive ions so easily. Less energy is also needed to remove electrons from larger atoms in the same group. For example, in

group 1, it takes less energy to remove an electron from francium (Fr) at the bottom of the group than from lithium (Li) at the top of the group (see **Figure 7.4**). In bigger atoms, valence electrons are farther from the nucleus. As a result, the force of attraction between the electrons and nucleus is weaker.

What happens when an atom gains an electron and becomes a negative ion? Energy is released. Halogens release the most energy when they form ions. As a result, they are very reactive.

Ionic Compounds

Ionic compounds contain ions of metals and nonmetals held together by ionic bonds. Ionic compounds do not form molecules. Instead, many positive and negative ions bond together to form a structure called a crystal. You can see an example of a crystal in **Figure 7.5**. It shows the ionic compound sodium chloride. Positive sodium ions (Na^+) alternate with negative chloride ions (Cl^-). The oppositely charged ions are strongly attracted to each other.

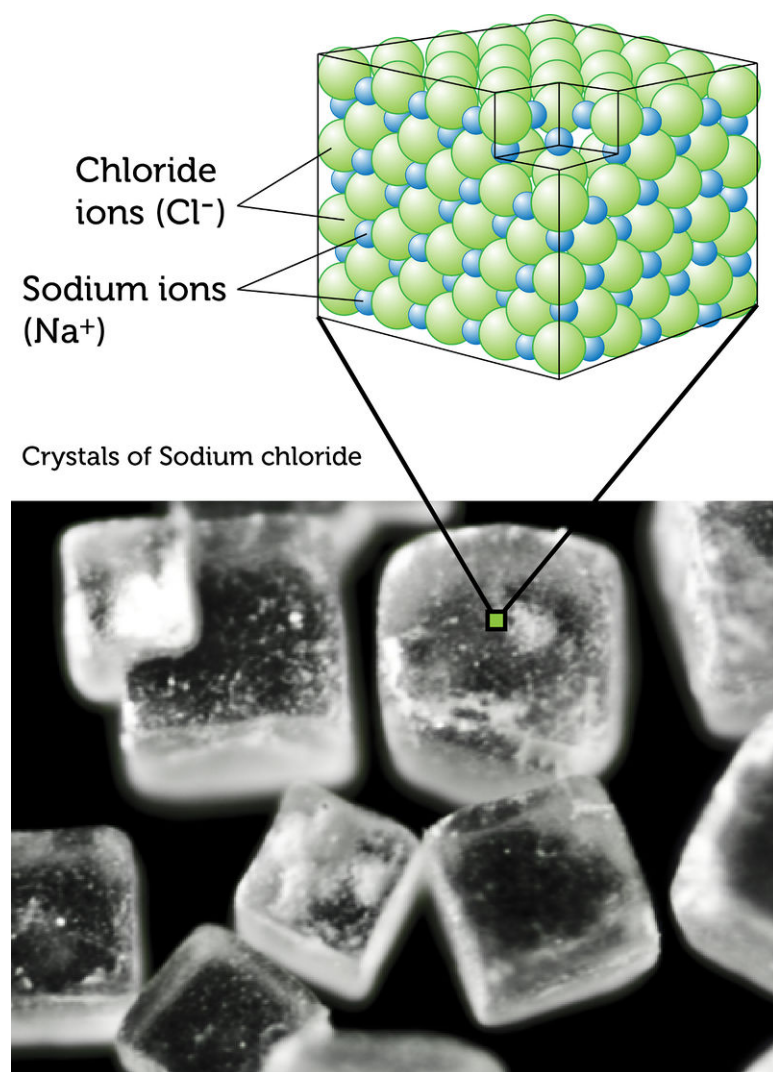

FIGURE 7.5

Sodium chloride crystals are cubic in shape. Other ionic compounds may have crystals with different shapes.

Helpful Hints

Naming Ionic Compounds Ionic compounds are named for their positive and negative ions. The name of the positive

ion always comes first. For example, sodium and chloride ions form the compound named sodium chloride.

You Try It!

Problem: What is the name of the ionic compound composed of positive barium ions and negative iodide ions?

Properties of Ionic Compounds

The crystal structure of ionic compounds is strong and rigid. It takes a lot of energy to break all those strong ionic bonds. As a result, ionic compounds are solids with high melting and boiling points (see **Table 7.2**). The rigid crystals are brittle and more likely to break than bend when struck. As a result, ionic crystals tend to shatter. You can learn more about the properties of ionic compounds by watching the video at this URL: http://www.youtube.com/watch?v=buWrSgs_ZHk (3:34).

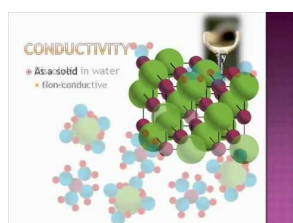

MEDIA

Click image to the left for more content.

Compare the melting and boiling points of these ionic compounds with those of water (0°C and 100°C), which is *not* an ionic compound.

TABLE 7.2: Melting and Boiling Points of Select Ionic Compounds

Ionic Compound	Melting Point (°C)	Boiling Point (°C)
Sodium chloride (NaCl)	801	1413
Calcium chloride (CaCl ₂)	772	1935
Barium oxide (BaO)	1923	2000
Iron bromide (FeBr ₃)	684	934

Solid ionic compounds are poor conductors of electricity. The strong bonds between ions lock them into place in the crystal. However, in the liquid state, ionic compounds are good conductors of electricity. Most ionic compounds dissolve easily in water. When they dissolve, they separate into individual ions. The ions can move freely, so they are good conductors of electricity. Dissolved ionic compounds are called electrolytes.

Uses of Ionic Compounds

Ionic compounds have many uses. Some are shown in **Figure 7.6**. Many ionic compounds are used in industry. The human body also needs several ions for good health. Having low levels of the ions can endanger important functions such as heartbeat. Solutions of ionic compounds can be used to restore the ions.

Lesson Summary

- An ionic bond is the force of attraction that holds together oppositely charged ions. It forms when atoms of a metal transfer electrons to atoms of a nonmetal. When this happens, the atoms become oppositely charged ions.

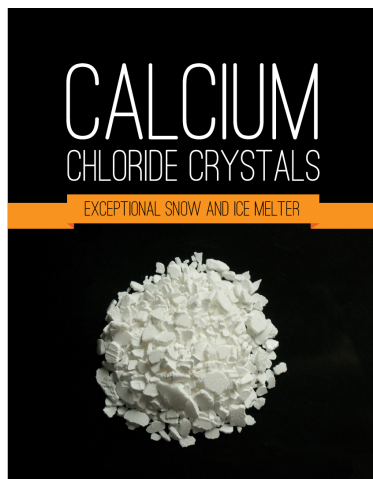

Calcium chloride crystals are used to melt ice and snow. The crystals lower the freezing point of water.



Potassium iodide tablets are given to people who are exposed to high levels of radiation. They protect the thyroid gland from radiation.



Barium chloride is used to make fireworks. It produces green-colored explosions.



Electrolyte solutions are given to children who have lost ions. This can happen with vomiting or diarrhea.

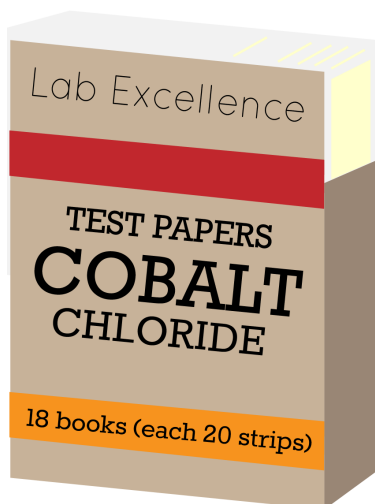

Cobalt chloride test papers are used to detect moisture. They change color when they absorb water.



Lithium iodide is used in batteries. It's an excellent conductor of electricity.

FIGURE 7.6

Have you ever used any of these ionic compounds?

- Ionic compounds form crystals instead of molecules. Ionic bonds are strong and the crystals are rigid. As a result, ionic compounds are brittle solids with high melting and boiling points. In the liquid state or dissolved in water, ionic compounds are good conductors of electricity.

Lesson Review Questions

Recall

1. What is an ionic bond?
2. Outline the role of energy in the formation of an ionic bond.
3. List properties of ionic compounds.

Apply Concepts

4. Create a model to represent the ionic bonds in a crystal of the salt lithium iodide (LiI).
5. A mystery compound is a liquid with a boiling point of 50°C. Is it likely to be an ionic compound? Why or why not?

Think Critically

6. Explain why ionic bonds form only between atoms of metals and nonmetals.

Points to Consider

Bonds form not only between atoms of metals and nonmetals. Nonmetals may also bond with nonmetals.

- How do you think bonds form between atoms of nonmetals?
- Can you think of examples of compounds that consist only of nonmetals?

7.3 Covalent Bonds

Lesson Objectives

- Describe how covalent bonds form.
- Compare properties of polar and nonpolar covalent compounds.

Lesson Vocabulary

- covalent bond
- covalent compound
- hydrogen bond
- nonpolar
- polar

Introduction

Covalent bonds are bonds in which atoms share rather than transfer electrons. Compounds with covalent bonds are called covalent compounds.

Formation of Covalent Bonds

A **covalent bond** is the force of attraction that holds together two atoms that share a pair of electrons. The shared electrons are attracted to the nuclei of both atoms. Covalent bonds form only between atoms of nonmetals. The two atoms may be the same or different elements. If the bonds form between atoms of different elements, a covalent compound forms. Covalent compounds are described in detail later in the lesson. To see a video about covalent bonding, go to this URL: http://www.youtube.com/watch?v=-Eh_ODseg3E (6:20).

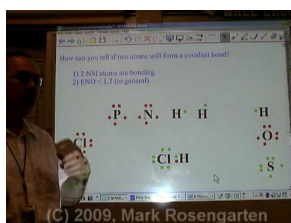

MEDIA

Click image to the left for more content.

Figure 7.7 shows an example of a covalent bond forming between two atoms of the same element, in this case two atoms of hydrogen. The two atoms share a pair of electrons. Hydrogen normally occurs in two-atom, or diatomic,

molecules like this (*di-* means "two"). Several other elements also normally occur as diatomic molecules: nitrogen, oxygen, and all but one of the halogens (fluorine, chlorine, bromine, and iodine).

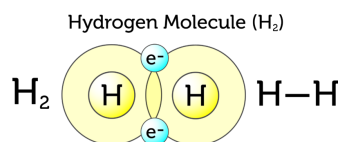

FIGURE 7.7

This figure shows three ways of representing a covalent bond. A dash (-) between two atoms represents one pair of shared electrons.

Why Covalent Bonds Form

Covalent bonds form because they give atoms a more stable arrangement of electrons. Look at the hydrogen atoms in **Figure 7.7**. Alone, each hydrogen atom has just one electron. By sharing electrons with another hydrogen atom, it has two electrons: its own and the one in the other hydrogen atom. The shared electrons are attracted to both hydrogen nuclei. This force of attraction holds the two atoms together as a molecule of hydrogen.

Some atoms need to share more than one pair of electrons to have a full outer energy level. For example, an oxygen atom has six valence electrons. It needs two more electrons to fill its outer energy level. Therefore, it must form two covalent bonds. This can happen in many different ways. One way is shown in **Figure 7.8**. The oxygen atom in the figure has covalent bonds with two hydrogen atoms. This forms the covalent compound water.

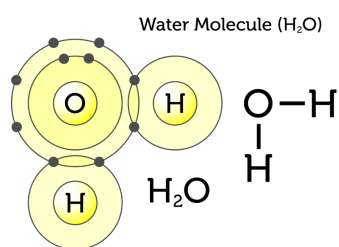

FIGURE 7.8

An oxygen atom has a more stable arrangement of electrons when it forms covalent bonds with two hydrogen atoms.

Polar and Nonpolar Covalent Bonds

In some covalent bonds, electrons are not shared equally between the two atoms. These are called **polar** bonds. **Figure 7.9** shows this for water. The oxygen atom attracts the shared electrons more strongly because its nucleus has more positively charged protons. As a result, the oxygen atom becomes slightly negative in charge. The hydrogen atoms attract the electrons less strongly. They become slightly positive in charge. For another example of polar bonds, see the video at this URL: <http://www.youtube.com/watch?v=1lnjg81daBs> (0:52).



MEDIA

Click image to the left for more content.

Polar Bonds in a Water Molecule

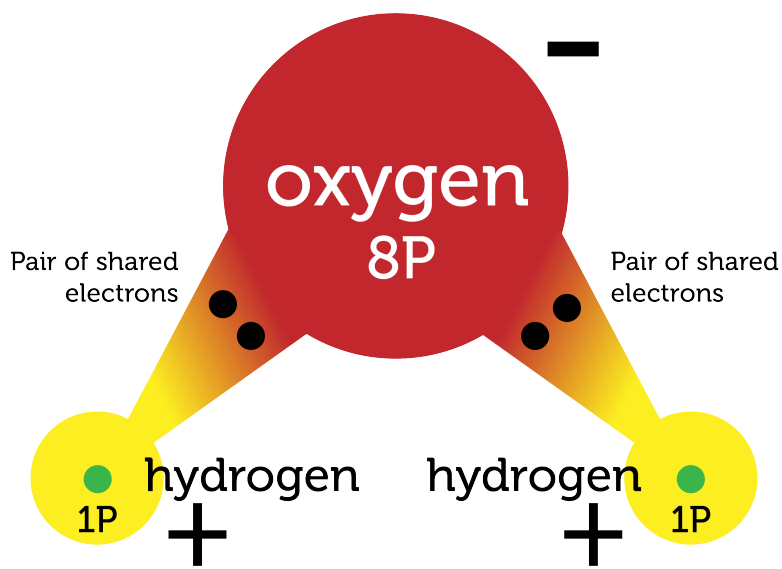

FIGURE 7.9

A water molecule has two polar bonds.

In other covalent bonds, electrons are shared equally. These bonds are called **nonpolar** bonds. Neither atom attracts the shared electrons more strongly. As a result, the atoms remain neutral. **Figure 7.10** shows an example of nonpolar bonds.

Nonpolar Bonds in an Oxygen Molecule (O_2)

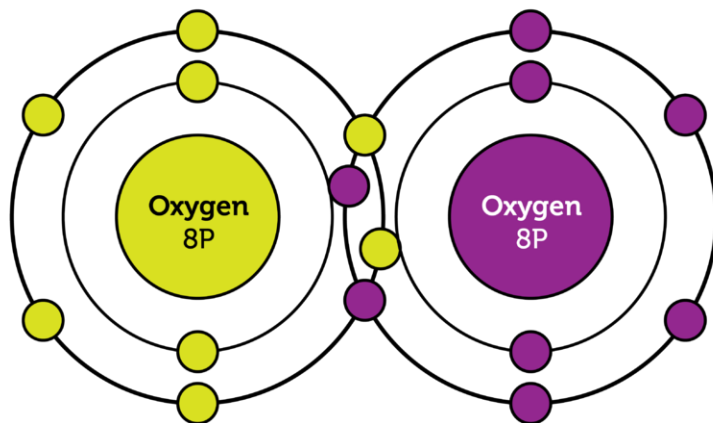

FIGURE 7.10

An oxygen molecule has two nonpolar bonds. This is called a double bond. The two oxygen atoms attract equally the four shared electrons.

Covalent Compounds

Covalent bonds between atoms of different elements form **covalent compounds**. The smallest, simplest covalent compounds have molecules with just two atoms. An example is hydrogen chloride (HCl). It consists of one hydrogen atom and one chlorine atom. The largest, most complex covalent molecules have thousands of atoms. Examples

include proteins and carbohydrates. These are compounds in living things.

Helpful Hints

Naming Covalent Compounds Follow these rules in naming simple covalent compounds:

- The element closer to the left of the periodic table is named first.
- The second element gets the suffix *-ide*.
- Prefixes such as *di-* (2) and *tri-* (3) show the number of each atom in the compound. These are written with subscripts in the chemical formula.

Example: The gas that consists of one carbon atom and two oxygen atoms is named carbon dioxide. Its chemical formula is CO_2 .

You Try It!

Problem: What is the name of the compound that contains three oxygen atoms and two nitrogen atoms? What is its chemical formula?

Properties of Covalent Compounds

Covalent compounds have different properties than ionic compounds because of their bonds. Covalent compounds exist as individual molecules rather than crystals. It takes less energy for individual molecules than ions in a crystal to pull apart. As a result, covalent compounds have lower melting and boiling points than ionic compounds. Many are gases or liquids at room temperature. Covalent compounds have shared electrons. These are not free to move like the transferred electrons of ionic compounds. This makes covalent compounds poor conductors of electricity. Many covalent compounds also do not dissolve in water as all ionic compounds do.

Polar and Nonpolar Covalent Compounds

Having polar bonds may make a covalent compound polar. A polar compound is one in which there is a slight difference in charge between opposite ends of the molecule. All polar compounds contain polar bonds. But having polar bonds does not necessarily result in a polar compound. It depends on how the atoms are arranged. This is illustrated in **Figure 7.11**. Both molecules in the figure contain polar bonds, but only formaldehyde is a polar compound. Why is carbon dioxide nonpolar?

The molecules of polar compounds are attracted to each other. You can see this in **Figure 7.12** for water. A bond forms between the positive hydrogen end of one water molecule and the negative oxygen end of another water molecule. This type of bond is called a **hydrogen bond**. Hydrogen bonds are weak, but they still must be overcome when a polar substance changes from a solid to a liquid or from a liquid to a gas. As a result, polar covalent compounds may have higher melting and boiling points than nonpolar covalent compounds. To learn more about hydrogen bonding and when it occurs, see the video at this URL: <http://www.youtube.com/watch?v=lk15cbfqFRM> (0:58).

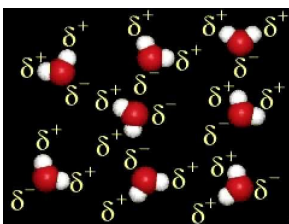

MEDIA

Click image to the left for more content.

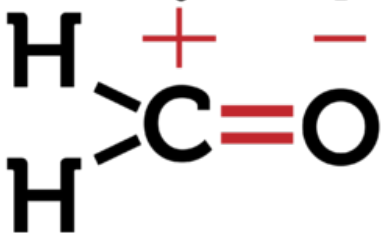
Formaldehyde (CH₂O)

Formaldehyde is a polar compound. One end of the molecule has a slightly positive charge. The other end has a slightly negative charge.

Carbon Dioxide (CO₂)

Carbon dioxide is a nonpolar compound. Both ends of the molecule are slightly negative in charge.

FIGURE 7.11

Covalent compounds may be polar or nonpolar, as these two examples show. In both molecules, the oxygen atoms attract electrons more strongly than the carbon or hydrogen atoms do.

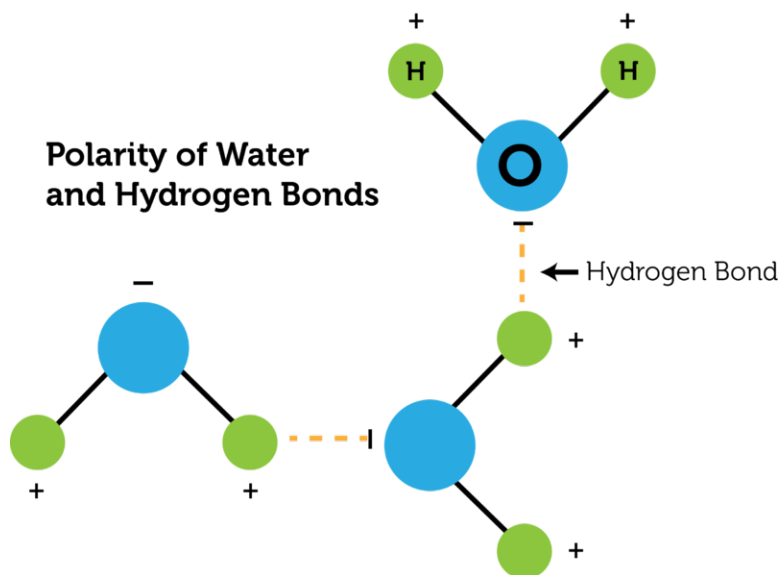
Polarity of Water and Hydrogen Bonds**FIGURE 7.12**

Water is a polar compound, so its molecules are attracted to each other and form hydrogen bonds.

Lesson Summary

- A covalent bond is the force of attraction that holds together two atoms that share a pair of electrons. It forms between atoms of the same or different nonmetals. In polar covalent bonds, one atom attracts the shared electrons more strongly and becomes slightly negative. The other atom becomes slightly positive.
- Covalent compounds form individual molecules rather than crystals. Compared with ionic compounds, they have low melting and boiling points. They are also poor conductors of electricity. In polar covalent compounds, oppositely charged ends of different molecules attract each other. This affects the properties of polar

compounds.

Lesson Review Questions

Recall

1. What is a covalent bond?
2. What is the difference between a polar and nonpolar covalent bond?
3. List general properties of covalent compounds.

Apply Concepts

4. The electron dot diagram below represents a covalent compound. Do you think it is a polar or nonpolar compound? Explain.

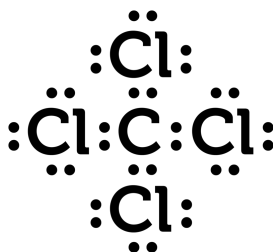

Think Critically

5. Explain why covalent bonds form.

Points to Consider

You read in this lesson that covalent bonds may form between atoms of the same nonmetal element. For example, hydrogen atoms (H) commonly form covalent bonds to form hydrogen molecules (H₂).

- Do you think bonds may also form between atoms of the same metallic element?
- Predict what these metallic bonds might be like.

7.4 Metallic Bonds

Lesson Objectives

- Describe how metallic bonds form.
- Relate the nature of metallic bonds to the properties of metals.
- Identify alloys and their uses.

Lesson Vocabulary

- alloy
- metallic bond

Introduction

Special bonds form in metals that do not form in other classes of elements. They are called metallic bonds. The bonds explain some of the unique properties of elements in the metals class.

Formation of Metallic Bonds

A **metallic bond** is the force of attraction between a positive metal ion and the valence electrons it shares with other ions of the metal. The positive ions form a lattice-like structure. You can see an example in **Figure 7.13**. (For an animated version, go to the URL below.) The ions are held together in the lattice by bonds with the valence electrons around them. These valence electrons include their own and those of other ions. Why do metallic bonds form? Recall that metals "want" to give up their valence electrons. This means that their valence electrons move freely. The electrons form a "sea" of negative charge surrounding the positive ions.

<http://www.youtube.com/watch?v=c4udBSZfLHY> (1:50)



MEDIA

Click image to the left for more content.

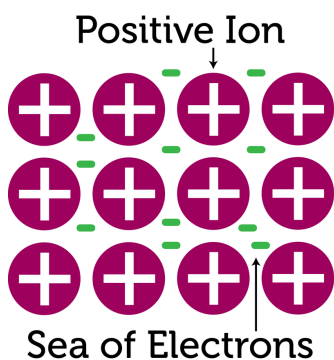

FIGURE 7.13

Positive metal ions and their shared electrons form metallic bonds.

Metallic Bonds and the Properties of Metals

Because of their freely moving electrons, metals are good conductors of electricity. Metals also can be shaped without breaking. They are ductile (can be shaped into wires) and malleable (can be shaped into thin sheets). Metals have these properties because of the nature of their metallic bonds.

A metallic lattice, like the one in **Figure 7.13**, may resemble a rigid ionic crystal. However, it is much more flexible. Look at **Figure 7.14**. It shows a blacksmith hammering a piece of red-hot iron in order to shape it. Why doesn't the iron shatter, as an ionic crystal would? The ions of the metal can move within the "sea" of electrons without breaking the metallic bonds that hold them together. The ions can shift closer together or farther apart. In this way, the metal can change shape without breaking. You can learn more about metallic bonds and the properties of metals at this URL: <http://www.youtube.com/watch?v=ap5pHBWwpu4> (6:12).



MEDIA

Click image to the left for more content.

Alloys

Metals are useful for many purposes because of their unique properties. However, pure metals may be less useful than mixtures of metals. For example, iron is not as strong as steel, which is a mixture of iron and small amounts of carbon. Steel is so strong that it can hold up huge bridges, like the one **Figure 7.15**. Steel is also used to make skyscrapers, cargo ships, cars, and trains.

Steel is an example of an alloy. An **alloy** is a mixture of a metal with one or more other elements. The other elements may be metals, nonmetals, or both. An alloy is a solid solution. It is formed by melting a metal and dissolving the other elements in it. The molten solution is then allowed to cool and harden. Several other examples of alloys and their uses are shown in **Figure 7.16**. You can learn about an amazing alloy called memory wire at the URL below. If you have braces on your teeth, you may even have this alloy in your mouth!

<http://www.youtube.com/watch?v=LSNRwtTMH6w>



FIGURE 7.14

A blacksmith shapes a piece of iron.



FIGURE 7.15

The girders of this bridge are made of steel.

Lesson Summary

- A metallic bond is the force of attraction between a positively charged metal ion and the valence electrons it shares with other ions of the metal. The electrons move freely around the positive ions, which form a lattice-like structure.
- With freely moving electrons, metals are good conductors of electricity. The positive ions of metals can also move within the "sea" of electrons without breaking the metallic bonds that hold them together. This allows metals to change shape without breaking.
- Pure metals may be less useful than mixtures of metals, called alloys. Examples of alloys include steel, bronze, and brass.

Brass saxophone

Brass is an alloy of copper and zinc. It is softer than bronze and easier to shape. It's also very shiny. Notice the curved pieces in this shiny brass saxophone. Brass is used for shaping many other curved objects, such as doorknobs and plumbing fixtures.

Stainless steel sink

Stainless steel is a type of steel that contains nickel and chromium in addition to carbon and iron. It is shiny, strong, and resistant to rusting. This makes it useful for sinks, eating utensils, and other objects that are exposed to water.

"Gold" bracelet

Pure gold is relatively soft, so it is rarely used for jewelry. Most "gold" jewelry is actually made of an alloy of gold, copper, and silver.

Bronze statue

Bronze was the first alloy ever made. The earliest bronze dates back many thousands of years. Bronze is a mixture of copper and tin. Both copper and tin are relatively soft metals, but mixed together in bronze they are much harder. Bronze has been used for statues, coins, and other objects.

FIGURE 7.16

Most metal objects are made of metal alloys rather than pure metals.

Lesson Review Questions

Recall

1. What is a metallic bond?
2. Define alloy and give three examples.

Apply Concepts

3. Create a model to represent the metallic bonds in solid iron (Fe).

Think Critically

4. Relate metallic bonds to the properties of metals.
5. Compare and contrast metallic and ionic bonds.

Points to Consider

Compounds form when atoms of different elements combine. This process is a chemical reaction.

- How would you define chemical reaction?
- How do you think chemical reactions are related to chemical changes in matter, such as wood burning and iron rusting?

7.5 References

1. Christopher Auyeung. [CK-12 Foundation](#) . CC BY-NC 3.0
2. Water: Derek Jensen (Wikimedia: Tysto); Hydrogen peroxide: Robert Lopez; Girl blowing out candle: Image copyright arek_malang, 2013; Carbon monoxide detector: User:Sideroxylon/Wikimedia Commons. [Water: http://commons.wikimedia.org/wiki/File:Glass-of-water.jpg](http://commons.wikimedia.org/wiki/File:Glass-of-water.jpg); [Hydrogen peroxide: CK-12](#); [Girl blowing out candle: http://www.shutterstock.com](http://www.shutterstock.com); [Carbon monoxide detector: http://commons.wikimedia.org/wiki/File:CO_detector.JPG](http://commons.wikimedia.org/wiki/File:CO_detector.JPG) . Water: Public Domain; Hydrogen peroxide: CC BY-NC; Girl blowing out candle: Used under licenses from Shutterstock.com; Carbon monoxide detector: Public Domain
3. Christopher Auyeung. [CK-12 Foundation](#) . CC BY-NC 3.0
4. Christopher Auyeung. [CK-12 Foundation](#) . CC BY-NC 3.0
5. Salt: Tony L Wong; Illustration: Christopher Auyeung (CK-12 Foudnation). <http://www.flickr.com/photos/tonylwong/3954263897/> . CC BY 2.0
6. Fireworks:Epic Fireworks; Battery: Lukas A, CZE; Others: Christopher Auyeung (CK-12 Foundation). [Fire works: http://www.flickr.com/photos/epicfireworks/8838128619/](http://www.flickr.com/photos/epicfireworks/8838128619/); [Battery: http://commons.wikimedia.org/wiki/File:Energizer_lithium.jpg](http://commons.wikimedia.org/wiki/File:Energizer_lithium.jpg) . Fireworks: CC BY 2.0; Battery: Public Domain; Others: CC BY-NC 3.0
7. Christopher Auyeung. [CK-12 Foundation](#) . CC BY-NC 3.0
8. Christopher Auyeung. [CK-12 Foundation](#) . CC BY-NC 3.0
9. Christopher Auyeung. [CK-12 Foundation](#) . CC BY-NC 3.0
10. Christopher Auyeung. [CK-12 Foundation](#) . CC BY-NC 3.0
11. Christopher Auyeung. [CK-12 Foundation](#) . CC BY-NC 3.0
12. Christopher Auyeung. [CK-12 Foundation](#) . CC BY-NC 3.0
13. Christopher Auyeung. [CK-12 Foundation](#) . CC BY-NC 3.0
14. Derek Key. <http://www.flickr.com/photos/derekskey/5249580870/> . CC BY 2.0
15. Nate Silva. <http://commons.wikimedia.org/wiki/File:Steel-bridge-800x600.JPG> . Public Domain
16. Saxophone: Thor (Flickr:Geishaboy500); Sink: Granite Charlotte Countertops; Bracelet: Maegan Tintari; Status: Elliot Brown. [Statue: http://www.flickr.com/photos/geishaboy500/1103796516/](http://www.flickr.com/photos/geishaboy500/1103796516/); [Sink: http://www.flickr.com/photos/46317749@N02/4403383547/](http://www.flickr.com/photos/46317749@N02/4403383547/); [Bracelet: http://www.flickr.com/photos/lovemaegan/6877739921/](http://www.flickr.com/photos/lovemaegan/6877739921/); [Status: http://www.flickr.com/photos/ell-r-brown/6277693589/](http://www.flickr.com/photos/ell-r-brown/6277693589/) . CC BY 2.0

CHAPTER 8

Chemical Reactions

Chapter Outline

- 8.1 INTRODUCTION TO CHEMICAL REACTIONS
- 8.2 CHEMICAL EQUATIONS
- 8.3 TYPES OF CHEMICAL REACTIONS
- 8.4 CHEMICAL REACTIONS AND ENERGY
- 8.5 REFERENCES



Does the term "chemical reaction" bring to mind an image like this one? In the picture, a chemist is mixing chemicals in a lab. Many chemical reactions take place in labs. However, most chemical reactions do not. Where do they occur? They happen in the world all around you. They even happen inside your own body. In fact, you would not be alive if it were not for the many chemical reactions that take place inside your cells. In this chapter, you will learn about chemical reactions, including two very important reactions that take place in living things.

Image copyright emin kulyev, 2013. www.shutterstock.com. Used under license from Shutterstock.com.

8.1 Introduction to Chemical Reactions

Lesson Objectives

- Describe how chemical reactions occur.
- List signs that a chemical reaction has occurred.

Lesson Vocabulary

- chemical reaction
- equilibrium
- product
- reactant

Introduction

No doubt you've seen changes like those pictured in **Figure 8.1**. What do all these changes have in common? They are all chemical changes in matter. In a chemical change, matter changes into a different substance with different properties. Chemical changes occur because of chemical reactions. You can see more examples of chemical changes at this URL: <http://www.youtube.com/watch?v=66kuhJkQCVM> (2:05).



MEDIA

Click image to the left for more content.

What Is a Chemical Reaction?

A **chemical reaction** is a process in which some substances change into different substances. Substances that start a chemical reaction are called **reactants**. Substances that are produced in the reaction are called **products**. Reactants and products can be elements or compounds. A chemical reaction can be represented by this general equation:

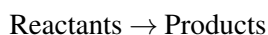

Metal rusting



Candle burning



Bananas turning brown



Fire extinguisher foaming

**FIGURE 8.1**

Each of these pictures shows a chemical change taking place.

The arrow (\rightarrow) shows the direction in which the reaction occurs. The reaction may occur quickly or slowly. For example, foam shoots out of a fire extinguisher as soon as the lever is pressed. But it might take years for metal to rust.

Breaking and Reforming Chemical Bonds

In chemical reactions, bonds break in the reactants and new bonds form in the products. The reactants and products contain the same atoms, but they are rearranged during the reaction. As a result, the atoms are in different combinations in the products than they were in the reactants.

Look at the example in **Figure 8.2**. It shows how water forms. Bonds break in molecules of hydrogen and oxygen. Then new bonds form in molecules of water. In both reactants and products, there are four hydrogen atoms and two oxygen atoms. But the atoms are combined differently in water. You can see another example at this URL: http://www.avogadro.co.uk/h_and_o/bondenthalpy/bondenthalpy.htm .

Reaction Direction and Equilibrium

The arrow in **Figure 8.2** shows that the reaction goes from left to right, from hydrogen and oxygen to water. The reaction can also go in the reverse direction. If an electric current passes through water, water molecules break down into molecules of hydrogen and oxygen. This reaction would be represented by a right-to-left arrow (\leftarrow) in **Figure 8.2**.

Many other reactions can also go in both forward and reverse directions. Often, a point is reached at which the forward and reverse reactions occur at the same rate. When this happens, there is no overall change in the amount of reactants and products. This point is called **equilibrium**, which refers to a balance between any opposing changes. You can see an animation of a chemical reaction reaching equilibrium at this URL: <http://www.tutorvista.com/content/chemistry/chemistry-ii/chemical-equilibrium/chemical-equilibrium-animation.php> .

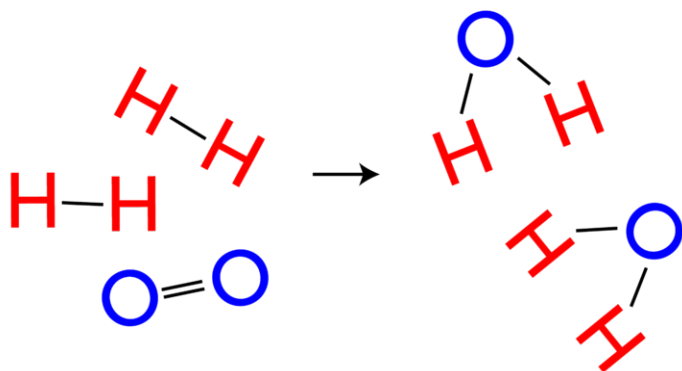
**FIGURE 8.2**

A chemical reaction changes hydrogen and oxygen to water.

Evidence of Chemical Reactions

Not all changes in matter involve chemical reactions. For example, there are no chemical reactions involved in changes of state. When liquid water freezes or evaporates, it is still water. No bonds are broken and no new products are formed.

How can you tell whether a change in matter involves a chemical reaction? Often, there is evidence. Four common signs that a chemical reaction has occurred are:

- Change in color: the products are a different color than the reactants.
- Change in temperature: heat is released or absorbed during the reaction.
- Production of a gas: gas bubbles are released during the reaction.
- Production of a solid: a solid settles out of a liquid solution. The solid is called a precipitate.

You can see examples of each type of evidence in **Figure 8.3** and at this URL: <http://www.youtube.com/watch?v=s0j1EZJ1Uc> (9:57).

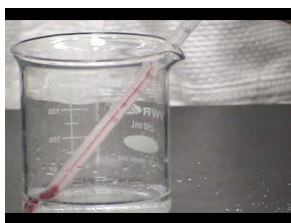

MEDIA

Click image to the left for more content.

Lesson Summary

- A chemical reaction is a process in which some substances change into different substances. In a chemical reaction, bonds break in reactants and new bonds form in products.
- Evidence that a chemical reaction has occurred include a change in color, a change in temperature, the production of a gas, or the formation of a precipitate.



Change in color
Bleaching hair changes its color.



Change in temperature
Burning wood produces heat.



Production of a gas
Dissolving an antacid tablet in water produces gas bubbles.



Production of a solid
Adding acid to milk produces solid curds of cottage cheese.

FIGURE 8.3

Can you think of other examples of changes like these? If so, they probably indicate that a chemical reaction has occurred.

Lesson Review Questions

Recall

1. Define chemical reaction.
2. What are the reactants and products in a chemical reaction?
3. Describe what happens to the atoms involved in a chemical reaction.
4. List four common signs that a chemical reaction has occurred.

Apply Concepts

5. Tina made a "volcano" by pouring vinegar over a "mountain" of baking soda. The wet baking soda bubbled and foamed. Did a chemical reaction occur? How do you know?

Think Critically

6. Explain the meaning of the term "equilibrium" as it applies to a chemical reaction. How can you tell when a chemical reaction has reached equilibrium?

Points to Consider

In **Figure 8.2**, you saw how hydrogen and oxygen combine chemically to form water.

- How could you use chemical symbols and formulas to represent this reaction?
- How many molecules of hydrogen and oxygen are involved in this reaction? How many molecules of water are produced? How could you include these numbers in your representation of the reaction?

8.2 Chemical Equations

Lesson Objectives

- Describe how to write chemical equations.
- Demonstrate how to balance chemical equations.
- Relate the law of conservation of mass to balancing chemical equations.

Lesson Vocabulary

- chemical equation

Introduction

Chemists use a standard method to represent chemical reactions. It includes chemical symbols and formulas to stand for reactants and products. The symbols and formulas are used to write chemical equations.

Writing Chemical Equations

A **chemical equation** is a symbolic representation of a chemical reaction. It is a shorthand way of showing how atoms are rearranged in the reaction. The general form of a chemical equation was introduced in this chapter's lesson "Introduction to Chemical Reactions." It is:

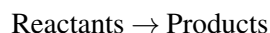

Consider the simple example in **Figure 8.4**. When carbon (C) reacts with oxygen (O₂), it produces carbon dioxide (CO₂). The chemical equation for this reaction is:

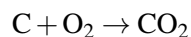

The reactants are one atom of carbon and one molecule of oxygen. When there is more than one reactant, they are separated by plus signs (+). The product is one molecule of carbon dioxide. If more than one product were produced, plus signs would be used between them as well.

Reaction: Carbon reacts with oxygen to produce carbon dioxide

Equation: $C + O_2 \rightarrow CO_2$

Arrangement of atoms:

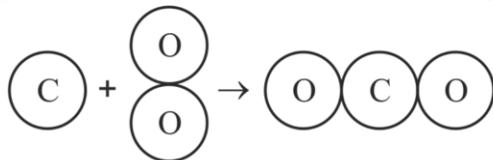

FIGURE 8.4

This figure shows a common chemical reaction. The drawing below the equation shows how the atoms are rearranged in the reaction. What chemical bonds are broken and what new chemical bonds are formed in this reaction?

Balancing Chemical Equations

Some chemical equations are more challenging to write. Consider the reaction in which hydrogen (H_2) and oxygen (O_2) combine to form water (H_2O). Hydrogen and oxygen are the reactants, and water is the product. To write a chemical equation for this reaction, you would start by writing symbols for the reactants and products:

Equation 1: $H_2 + O_2 \rightarrow H_2O$

Like equations in math, equations in chemistry must balance. There must be the same number of each type of atom in the products as there is in the reactants. In equation 1, count the number of hydrogen and oxygen atoms on each side of the arrow. There are two hydrogen atoms in both reactants and products. There are two oxygen atoms in the reactants but only one in the product. Therefore, equation 1 is not balanced.

Using Coefficients

Coefficients are used to balance chemical equations. A coefficient is a number placed in front of a chemical symbol or formula. It shows how many atoms or molecules of the substance are involved in the reaction. For example, two molecules of hydrogen would be written as $2H_2$. A coefficient of 1 usually isn't written.

Coefficients can be used to balance equation 1 (above) as follows:

Equation 2: $2H_2 + O_2 \rightarrow 2H_2O$

Equation 2 shows that two molecules of hydrogen react with one molecule of oxygen to produce two molecules of water. The two molecules of hydrogen each contain two hydrogen atoms. There are now four hydrogen atoms in both reactants and products. Is equation 2 balanced? Count the oxygen atoms to find out.

Steps in Balancing a Chemical Equation

Balancing a chemical equation involves a certain amount of trial and error. In general, however, you should follow these steps:

1. Count the number of each type of atom in reactants and products. Does the same number of each atom appear on both sides of the arrow? If not, the equation is not balanced, and you need to go to step 2.
2. Add coefficients to increase the number of atoms or molecules of reactants or products. Use the smallest coefficients possible.
3. Repeat steps 1 and 2 until the equation is balanced.

Helpful Hint

When you balance chemical equations, never change the subscripts in chemical formulas. Changing subscripts changes the substances involved in the reaction. Change only the coefficients.

Work through the **Problem Solving** examples below. Then do the **You Try It!** problems to check your understanding. If you need more help, go to this URL: <http://www.youtube.com/watch?v=RnGu3xO2h74> (14:28).

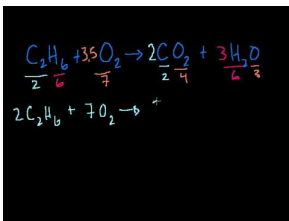

MEDIA

Click image to the left for more content.

Problem Solving

Problem: Balance this chemical equation: $\text{N}_2 + \text{H}_2 \rightarrow \text{NH}_3$

Hints for balancing

1. Two N are needed in the products to match the two N (N_2) in the reactants. Add the coefficient 2 in front of NH_3 . Now N is balanced.
2. Six H are now needed in the reactants to match the six H in the products. Add the coefficient 3 in front of H_2 . Now H is balanced.

Solution: $\text{N}_2 + 3\text{H}_2 \rightarrow 2\text{NH}_3$

Problem: Balance this chemical equation: $\text{CH}_4 + \text{O}_2 \rightarrow \text{CO}_2 + \text{H}_2\text{O}$

Solution: $\text{CH}_4 + 2\text{O}_2 \rightarrow \text{CO}_2 + 2\text{H}_2\text{O}$

You Try It!

Problem: Balance these chemical equations:

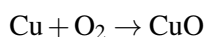
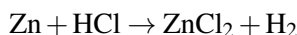

Conserving Mass

Why must chemical equations be balanced? It's the law! Matter cannot be created or destroyed in chemical reactions. This is the law of conservation of mass. In every chemical reaction, the same mass of matter must end up in the products as started in the reactants. Balanced chemical equations show that mass is conserved in chemical reactions.

How do scientists know that mass is always conserved in chemical reactions? Careful experiments in the 1700s by a French chemist named Antoine Lavoisier led to this conclusion. For this and other contributions, Lavoisier has been called the father of modern chemistry.

Lavoisier carefully measured the mass of reactants and products in many different chemical reactions. He carried out the reactions inside a sealed jar, like the one in **Figure 8.5**. As a result, any gases involved in the reactions were captured and could be measured. In every case, the total mass of the jar and its contents was the same after the reaction as it was before the reaction took place. This showed that matter was neither created nor destroyed in the reactions. Another outcome of Lavoisier's research was his discovery of oxygen. You can learn more about Lavoisier and his important research at: <http://www.youtube.com/watch?v=x9iZq3ZxbO8>

**FIGURE 8.5**

Lavoisier carried out several experiments inside a sealed glass jar. Why was sealing the jar important for his results?

Lesson Summary

- A chemical equation is a symbolic representation of a chemical reaction. It shows how atoms are rearranged in the reaction.
- Equations in chemistry must balance. There must be the same number of each type of atom in the products as there is in the reactants. Coefficients are used to balance chemical equations. They show how many atoms or molecules of a substance are involved in a reaction.
- Chemical equations must be balanced because matter cannot be created or destroyed. This is the law of conservation of mass. Experiments by Antoine Lavoisier led to this law.

Lesson Review Questions

Recall

1. What is a chemical equation? Give an example.
2. What is a coefficient? How are coefficients used in chemistry?
3. Describe how Antoine Lavoisier showed matter is conserved in chemical reactions.

Apply Concepts

4. Draw a sketch that shows how atoms are rearranged in the chemical reaction represented by equation 2.
5. Balance this chemical equation: $\text{Hg} + \text{O}_2 \rightarrow \text{HgO}$.

Think Critically

6. Explain why it is necessary to balance chemical equations.

Points to Consider

In this lesson, you saw examples of chemical reactions in which two reactants combine to yield a single product. This is called a synthesis reaction. It is just one type of chemical reaction.

- What might be other types of chemical reactions?
- How might one reactant produce more than one product?

8.3 Types of Chemical Reactions

Lesson Objectives

- Explain how synthesis reactions occur.
- Describe how decomposition reactions occur.
- Describe single and double replacement reactions.
- Explain how combustion reactions occur.

Lesson Vocabulary

- combustion reaction
- decomposition reaction
- replacement reaction
- synthesis reaction

Introduction

Most of the chemical reactions you have seen so far in this chapter are synthesis reactions. In this type of reaction, two or more reactants combine to synthesize a product. There are several other types of chemical reactions, including decomposition, replacement, and combustion reactions. You will read about all four types of reactions in this lesson. **Table 8.1** summarizes the four types of chemical reactions you will read about in the rest of the lesson. You can see demonstrations of each type at this URL: <http://www.youtube.com/watch?v=nVysOW0Lb8U> .

TABLE 8.1: Four Types of Chemical Reactions

Type of Reaction	General Equation	Example
Synthesis	$A + B \rightarrow C$	$2\text{Na} + \text{Cl}_2 \rightarrow 2\text{NaCl}$
Decomposition	$AB \rightarrow A + B$	$2\text{H}_2\text{O} \rightarrow 2\text{H}_2 + \text{O}_2$
Replacement	$A + BC \rightarrow B + AC$	$2\text{K} + 2\text{H}_2\text{O} \rightarrow 2\text{KOH} + \text{H}_2$
Single	$AB + CD \rightarrow AD + CB$	$\text{NaCl} + \text{AgF} \rightarrow \text{NaF} + \text{AgCl}$
Double		
Combustion	fuel + oxygen \rightarrow carbon dioxide + water	$\text{CH}_4 + 2\text{O}_2 \rightarrow \text{CO}_2 + 2\text{H}_2\text{O}$

Synthesis Reactions

A **synthesis reaction** occurs when two or more reactants combine to form a single product. A synthesis reaction can be represented by the general equation:

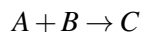

In this general equation (and others like it in this lesson), the letters A, B, C , and so on represent atoms or ions of elements. The arrow shows the direction of the reaction. The letters on the left side of the arrow are the reactants that begin the chemical reaction. The letters on the right side of the arrow are the product of the reaction. Two examples of synthesis reactions are described below. You can see more examples at this URL: <http://www.youtube.com/watch?v=dxIWtsFinTM> .

Synthesis Example 1

An example of a synthesis reaction is the combination of sodium (Na) and chlorine (Cl) to produce sodium chloride (NaCl). This reaction is represented by the chemical equation:

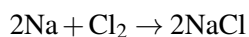

Sodium is a highly reactive metal, and chlorine is a poisonous gas (see **Figure 8.6**). The compound they synthesize has very different properties. It is table salt, which is neither reactive nor poisonous. In fact, salt is a necessary component of the human diet.

Sodium + Chlorine \rightarrow Sodium chloride

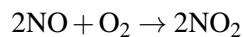

FIGURE 8.6

Sodium and chlorine combine to synthesize table salt.

Synthesis Example 2

Another example of a synthesis reaction is illustrated in **Figure 8.7**. The brown haze in the air over the city of Los Angeles is smog. A major component of smog is nitrogen dioxide (NO_2). It forms when nitric oxide (NO), from sources such as car exhaust, combines with oxygen (O_2) in the air. The equation for this reaction is:



Nitrogen dioxide is a toxic gas with a sharp odor. It can irritate the eyes and throat and trigger asthma attacks. It is a major air pollutant.

**FIGURE 8.7**

In this photo, the air over Los Angeles, California is brown with smog.

Decomposition Reactions

A decomposition reaction is the reverse of a synthesis reaction. In a **decomposition reaction**, one reactant breaks down into two or more products. This can be represented by the general equation:

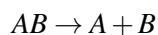

Two examples of decomposition reactions are described below. You can see other examples at this URL: <http://www.youtube.com/watch?v=dxlWtsFinTM> .

Decomposition Example 1

An example of a decomposition reaction is the breakdown of carbonic acid (H_2CO_3) to produce water (H_2O) and carbon dioxide (CO_2). The equation for this reaction is:

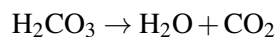

Carbonic acid is synthesized in the reverse reaction. It forms when carbon dioxide dissolves in water. For example, some of the carbon dioxide in the atmosphere dissolves in the ocean and forms carbonic acid. The amount of carbon dioxide in the atmosphere has increased over recent decades (see **Figure 8.8**). As a result, the acidity of ocean water is also increasing. How do you think this might affect ocean life?

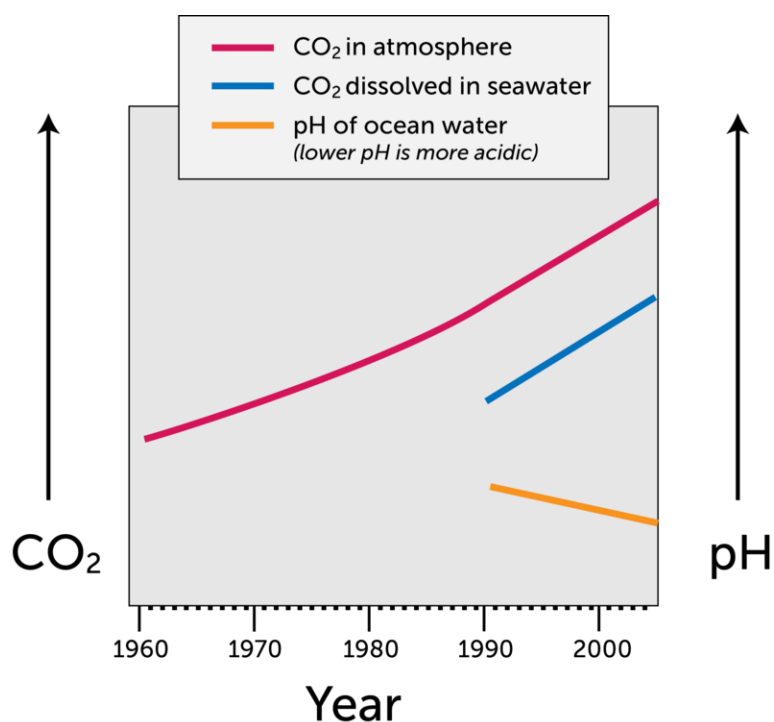
FIGURE 8.8

As carbon dioxide increases in the atmosphere, more carbon dioxide dissolves in ocean water.

Decomposition Example 2

Another example of a decomposition reaction is illustrated in **Figure 8.9**. Water (H₂O) decomposes to hydrogen (H₂) and oxygen (O₂) when an electric current passes through it. This reaction is represented by the equation:

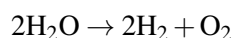

What is the reverse of this decomposition reaction? (*Hint*: How is water synthesized? You can look at this chapter's "Introduction to Chemical Reactions" lesson to find out.)

Replacement Reactions

Replacement reactions involve ions. They occur when ions switch places in compounds. There are two types of replacement reactions: single and double. Both types are described below.

Single Replacement Reactions

A single replacement reaction occurs when one ion takes the place of another in a single compound. This type of reaction has the general equation:

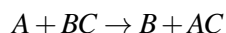

Do you see how *A* has replaced *B* in the compound? The compound *BC* has become the compound *AC*.

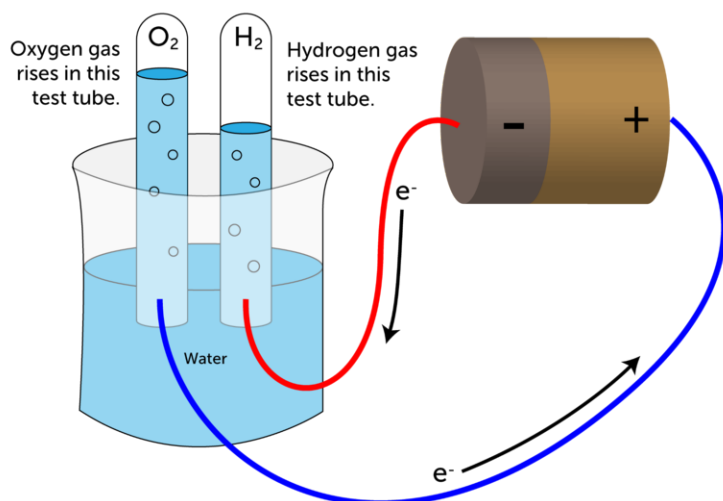
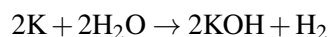

FIGURE 8.9

A decomposition reaction occurs when an electric current passes through water.

An example of a single replacement reaction occurs when potassium (K) reacts with water (H_2O). A colorless solid called potassium hydroxide (KOH) forms, and hydrogen gas (H_2) is released. The equation for the reaction is:



Potassium is a highly reactive group 1 alkali metal, so its reaction with water is explosive. You can actually watch this reaction occurring at: http://commons.wikimedia.org/wiki/File:Potassium_water_20.theora.ogv .

Double Replacement Reactions

A double replacement reaction occurs when two compounds exchange ions. This produces two new compounds. A double replacement reaction can be represented by the general equation:

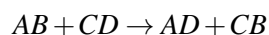

Do you see how *B* and *D* have changed places? Both reactant compounds have changed.

An example of a double replacement reaction is sodium chloride (NaCl) reacting with silver fluoride (AgF). This reaction is represented by the equation:

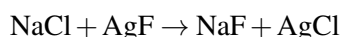

Cl and F have changed places. Can you name the products of this reaction?

Combustion Reactions

A **combustion reaction** occurs when a substance reacts quickly with oxygen (O_2). You can see an example of a combustion reaction in **Figure 8.10**. Combustion is commonly called burning. The substance that burns is usually

referred to as fuel. The products of a combustion reaction include carbon dioxide (CO₂) and water (H₂O). The reaction typically gives off heat and light as well. The general equation for a combustion reaction can be represented by:

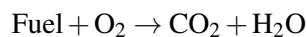
**FIGURE 8.10**

The burning of charcoal is an example of a combustion reaction.

Combustion Example 1

The fuel that burns in a combustion reaction is often a substance called a hydrocarbon. A hydrocarbon is a compound that contains only carbon (C) and hydrogen (H). Fossil fuels, such as natural gas, consist of hydrocarbons. Natural gas is a fuel that is commonly used in home furnaces and gas stoves (see **Figure 8.11**). The main component of natural gas is the hydrocarbon called methane (CH₄). The combustion of methane is represented by the equation:

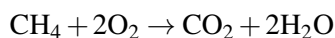

Combustion Example 2

Your own body cells burn fuel in combustion reactions. The fuel is glucose (C₆H₁₂O₆), a simple sugar. The process in which combustion of glucose occurs in body cells is called cellular respiration. This combustion reaction provides energy for life processes. Cellular respiration can be summed up by the equation:

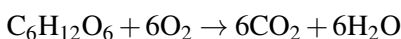

Where does glucose come from? It is produced by plants during photosynthesis. In this process, carbon dioxide and water combine to form glucose. Which type of chemical reaction is photosynthesis?

**FIGURE 8.11**

The blue flame on this gas stove is produced when natural gas burns.

Lesson Summary

- A synthesis reaction occurs when two or more reactants combine to form a single product.
- In a decomposition reaction, one reactant breaks down into two or more products. This is the reverse of a synthesis reaction.
- Replacement reactions occur when elements switch places in compounds. In a single replacement reaction, one element takes the place of another in a single compound. In a double replacement reaction, two compounds exchange elements.
- A combustion reaction occurs when a substance reacts quickly with oxygen. Combustion is commonly called burning. Carbon dioxide, water, and heat and light are products of combustion.

Lesson Review Questions

Recall

1. Write an equation for the chemical reaction in which hydrogen reacts with oxygen to form water. What type of reaction is this?
2. Write an equation for the reverse of the reaction in question 1. What type of reaction is this?
3. Name the type of reaction represented by this general equation: $AB + CD \rightarrow AD + CB$
4. In the general equation in question 3, what do the individual letters represent?
5. What are the reactants and products in a combustion reaction?

Apply Concepts

6. Apply lesson concepts to classify the following chemical reactions:
 - a. $Zn + 2HCl \rightarrow H_2 + ZnCl_2$
 - b. $2KClO_3 \rightarrow 2KCl + 3O_2$
 - c. $2KI + Cl_2 \rightarrow 2KCl + I_2$

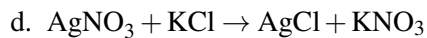

Think Critically

7. Compare and contrast the four types of reactions described in this lesson. Include an example of each type of reaction.

Points to Consider

Combustion reactions release energy. Some other types of reactions absorb energy. They need a continuous supply of energy to occur.

- Can you think of any chemical changes that might absorb energy?
- What might be different about reactions that need energy to keep going?

8.4 Chemical Reactions and Energy

Lesson Objectives

- Describe endothermic reactions.
- Describe exothermic reactions.
- Relate the law of conservation of energy to chemical reactions.
- Define activation energy.
- Identify factors that affect the rates of chemical reactions.

Lesson Vocabulary

- activation energy
- catalyst
- concentration
- endothermic reaction
- exothermic reaction
- law of conservation of energy
- reaction rate

Introduction

All chemical reactions involve energy. Energy is needed to break bonds in reactants. These bonds may be very strong. Energy is released when new bonds form in the products. That's because the atoms now have a more stable arrangement of electrons. Which energy is greater: that needed for breaking bonds in reactants or that released by bonds forming in products? It depends on the type of reaction. When it comes to energy, chemical reactions may be endothermic or exothermic.

Endothermic Reactions

In an **endothermic reaction**, it takes more energy to break bonds in the reactants than is released when new bonds form in the products. The word "endothermic" literally means "taking in heat." A constant input of energy, often in the form of heat, is needed in an endothermic reaction. Not enough energy is released when products form to break more bonds in the reactants. Additional energy is needed to keep the reaction going. The general equation for an endothermic reaction is:

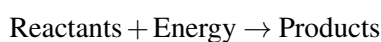

In many endothermic reactions, heat is absorbed from the surroundings. As a result, the temperature drops. The drop in temperature may be great enough to cause liquid products to freeze. That's what happens in the endothermic reaction at this URL: http://www.bbc.co.uk/schools/gcsebitesize/science/add_aqa/chemreac/energychangesrev1.shtml.

One of the most important endothermic reactions is photosynthesis. In this reaction, plants synthesize glucose ($C_6H_{12}O_6$) from carbon dioxide (CO_2) and water (H_2O). They also release oxygen (O_2). The energy for photosynthesis comes from light (see **Figure 8.12**). Without light energy, photosynthesis cannot occur. The chemical equation for photosynthesis is:

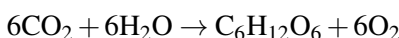
**FIGURE 8.12**

Plants can get the energy they need for photosynthesis from either sunlight or artificial light.

Exothermic Reactions

In an **exothermic reaction**, it takes less energy to break bonds in the reactants than is released when new bonds form in the products. The word "exothermic" literally means "turning out heat." Energy, often in the form of heat, is released as an exothermic reaction occurs. The general equation for an exothermic reaction is:



If the energy is released as heat, an exothermic reaction results in a rise in temperature. That's what happens in the exothermic reaction at the URL below.

http://www.bbc.co.uk/schools/gcsebitesize/science/add_aqa/chemreac/energychangesrev1.shtml

Combustion reactions are examples of exothermic reactions. When substances burn, they usually give off energy as heat and light. Look at the big bonfire in **Figure 8.13**. You can see the light energy it is giving off. If you were standing near the fire, you would also feel its heat.

Conservation of Energy

Whether a reaction absorbs energy or releases energy, there is no overall change in the amount of energy. Energy cannot be created or destroyed. This is the **law of conservation of energy**. Energy can change form—for example, from electricity to light—but the same amount of energy always remains.

**FIGURE 8.13**

The combustion of wood is an exothermic reaction that releases energy as heat and light.

If energy cannot be destroyed, what happens to the energy that is absorbed in an endothermic reaction? The energy is stored in the chemical bonds of the products. This form of energy is called chemical energy. In an endothermic reaction, the products have more stored chemical energy than the reactants. In an exothermic reaction, the opposite is true. The products have less stored chemical energy than the reactants. The excess energy in the reactants is released to the surroundings when the reaction occurs. The graphs in **Figure 8.14** show the chemical energy of reactants and products in each type of reaction.

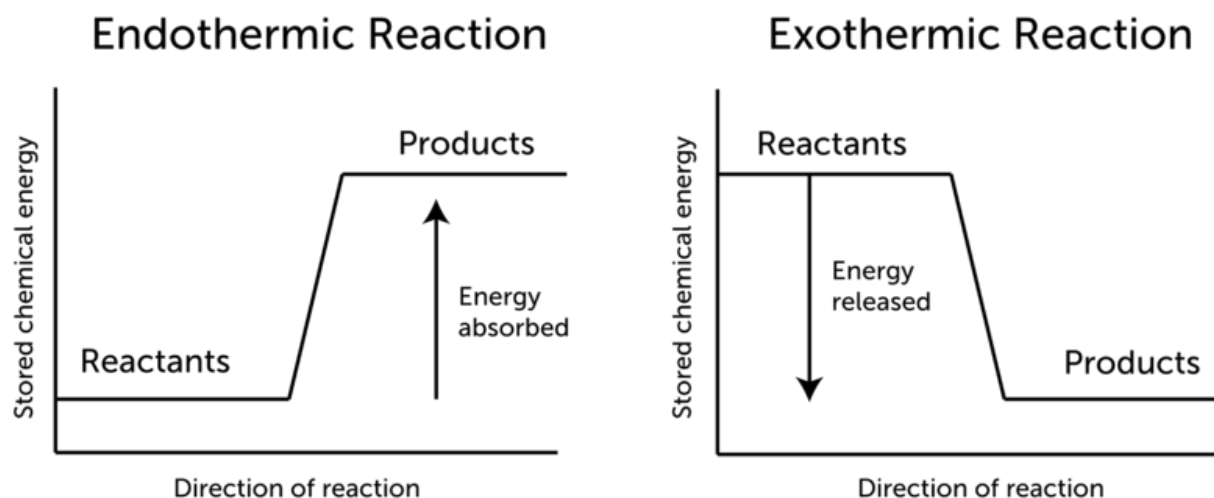
**FIGURE 8.14**

These graphs compare the energy changes in endothermic and exothermic reactions. What happens to the energy that is absorbed in an endothermic reaction?

Activation Energy

All chemical reactions, even exothermic reactions, need a certain amount of energy to get started. This energy is called **activation energy**. For example, activation energy is needed to start a car. Turning the key causes a spark that activates the burning of gasoline in the engine. The combustion of gas won't occur without the spark of energy to begin the reaction.

Why is activation energy needed? A reaction won't occur unless atoms or molecules of reactants come together.

This happens only if the particles are moving, and movement takes energy. Often, reactants have to overcome forces that push them apart. This takes energy as well. Still more energy is needed to start breaking bonds in reactants. The graphs in **Figure 8.15** show the changes in energy in endothermic and exothermic reactions. Both reactions need the same amount of activation energy in order to begin.

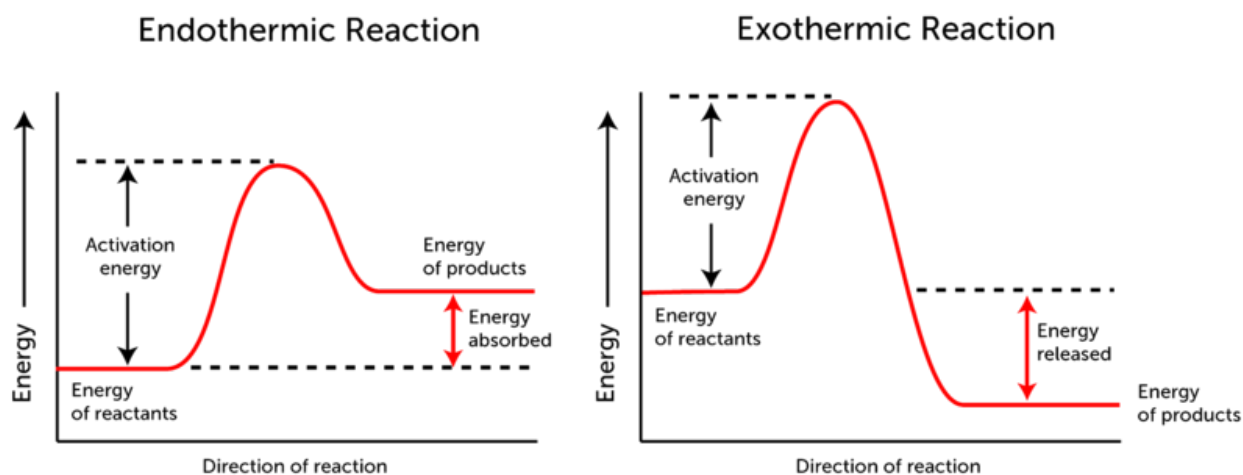
**FIGURE 8.15**

Even exothermic reactions need activation energy to get started.

You have probably used activation energy to start a chemical reaction. For example, if you've ever used a match to light a campfire, then you provided the activation energy needed to start a combustion reaction. Combustion is exothermic. Once a fire starts to burn, it releases enough energy to activate the next reaction, and the next, and so on. However, wood will not burst into flames on its own.

Reaction Rate

Any factor that helps reactants come together so they can react lowers the amount of activation energy needed to start the reaction. If the activation energy is lowered, more reactant particles can react, and the reaction occurs more quickly. How fast a reaction occurs is called the **reaction rate**. Factors that affect the reaction rate include:

- temperature of reactants
- concentration of reactants
- surface area of reactants
- presence of catalysts

Temperature of Reactants

When the temperature of reactants is higher, the rate of the reaction is faster. At higher temperatures, particles of reactants have more energy, so they move faster. They are more likely to bump into one another and to collide with greater force. For example, when you fry an egg, turning up the heat causes the egg to cook faster. The same

principle explains why storing food in a cold refrigerator reduces the rate at which food spoils (see **Figure 8.16**). Both food frying and food spoiling are chemical reactions that happen faster at higher temperatures.

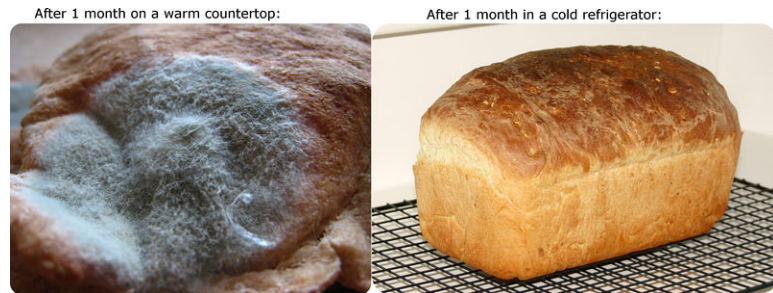
**FIGURE 8.16**

The chemical reactions that spoil food occur faster at higher temperatures.

Concentration of Reactants

Concentration is the number of particles of a substance in a given volume. When the concentration of reactants is higher, the reaction rate is faster. At higher concentrations, particles of reactants are crowded closer together, so they are more likely to collide and react. Did you ever see a sign like the one in **Figure 8.17**? You might see it where someone is using a tank of pure oxygen for a breathing problem. The greater concentration of oxygen in the air makes combustion rapid if a fire starts burning.

**FIGURE 8.17**

It's dangerous to smoke or use open flames when oxygen is in use. Can you explain why?

Surface Area of Reactants

When a solid substance is involved in a chemical reaction, only the matter at the surface of the solid is exposed to other reactants. If a solid has more surface area, more of it is exposed and able to react. Therefore, increasing the surface area of solid reactants increases the reaction rate. For example, crushing a solid into a powder exposes more of the substance to other reactants. This may greatly speed up the reaction. You can see another example in **Figure 8.18**. Iron rusts when it combines with oxygen in the air. The iron hammer head and iron nails will both rust eventually. Which will rust faster?

**FIGURE 8.18**

The nails have more surface area exposed to the air than the head of the hammer. How does this affect the rate at which they rust?

Presence of a Catalyst

Some reactions need extra help to occur quickly. They need another substance, called a catalyst. A **catalyst** is a substance that increases the rate of a chemical reaction but is not changed or used up in the reaction. The catalyst can go on to catalyze many more reactions.

Catalysts are not reactants, but they help reactants come together so they can react. You can see one way this happens in the animation at the URL below. By helping reactants come together, a catalyst decreases the activation energy needed to start a chemical reaction. This speeds up the reaction.

http://www.saskschools.ca/curr_content/chem30/modules/module4/lesson5/explainingcatalysts.htm

Living things depend on catalysts to speed up many chemical reactions inside their cells. Catalysts in living things are called enzymes. Enzymes may be extremely effective. A reaction that takes a split second to occur with an enzyme might take billions of years without it!

Lesson Summary

- In an endothermic reaction, it takes more energy to break bonds in the reactants than is released when new bonds form in the products. Therefore, an endothermic reaction needs a constant input of energy to keep going.
- In an exothermic reaction, it takes less energy to break bonds in the reactants than is released when new bonds form in the products. Therefore, an exothermic reaction releases enough energy to keep going.
- In any chemical reaction, there is no overall change in the amount of energy. Energy cannot be created or destroyed. This is the law of conservation of energy.
- All chemical reactions, even exothermic reactions, need activation energy to get started. Activation energy is needed to bring reactants together so they can react.
- How fast a reaction occurs is called the reaction rate. Factors that affect the reaction rate include catalysts and the temperature, concentration, and surface area of reactants. A catalyst is a substance that increases the rate of a chemical reaction but is not changed or used up in the reaction.

Lesson Review Questions

Recall

1. What form of energy is needed for the endothermic reaction called photosynthesis?
2. What evidence shows that combustion reactions are exothermic?

3. What happens to the energy that is absorbed in an endothermic reaction?
4. In an exothermic reaction, which has more stored chemical energy: the reactants or the products?
5. Define activation energy.
6. List four factors that affect the rates of chemical reactions.

Apply Concepts

7. Suppose you put a whole antacid tablet in one glass of water and a crushed antacid tablet in another glass containing the same amount of water. Both tablets would start reacting and producing bubbles of gas. Use lesson concepts to predict which tablet would stop producing bubbles first. Explain your prediction. Then, with the permission of an adult, do the activity. Do your results agree with your prediction?
8. Sketch a simple graph to show how energy changes in an exothermic reaction. Include activation energy in your graph.

Think Critically

9. Compare and contrast endothermic and exothermic chemical reactions.

Points to Consider

You read in this chapter that most fuels contain carbon. In the next chapter, "Chemistry of Carbon," you will learn much more about carbon.

- What do you already know about carbon?
- Based on carbon's position in the periodic table, predict how it reacts and the type of bonds it forms.

8.5 References

1. Rust: Flickr:babbagecabbage; Candle: Vincent Lock; Bananas: Sheila Sund (Flickr:docoverachiever); Fire extinguisher: DVIDSHUB. Rust: <http://www.flickr.com/photos/babbagecabbage/3259641816/>; Candle: <http://www.flickr.com/photos/27630470@N03/4310809978/>; Bananas: http://www.flickr.com/photos/sheila_sund/9697790732/; Fire extinguisher: <http://www.flickr.com/photos/dvids/3306357804/> . CC BY 2.0
2. Joy Sheng. [CK-12 Foundation](#) . CC BY-NC 3.0
3. Bleached hair: Image copyright Olga Sapegina, 2014; Camp fire: CopyrightFreePhotos.HQ101.com; Tablet: Image copyright Mikael Damkier, 2014; Cottage cheese: Image copyright eelnoisiva, 2014. [Bleached hair](#), [Tablet](#), [Cottage cheese](#): <http://www.shutterstock.com/>; [Camp fire](#): http://commons.wikimedia.org/wiki/File:Campfire_3.JPG . Bleached hair, Tablet, Cottage cheese: Used under license from Shutterstock.com; Camp fire: Public Domain
4. Christopher Auyeung. [CK-12 Foundation](#) . CC BY-NC 3.0
5. . http://commons.wikimedia.org/wiki/File:David_-_Portrait_of_Monsieur_Lavoisier_and_His_Wife.jpg . Public Domain
6. Sodium: User:Jurii/Wikimedia Commons; Chlorine: User:Greenhorn1/Wikimedia Commons; Salt: Dubravko Sorić. [Sodium](#): <http://commons.wikimedia.org/wiki/File:Sodium-1.jpg>; [Chlorine](#): <http://commons.wikimedia.org/wiki/File:Chlorine2.jpg>; [Salt](#): http://commons.wikimedia.org/wiki/File:Salt_shaker_on_white_background.jpg . Sodium: CC BY 3.0; Chlorine: Public Domain; Salt: CC BY 2.0
7. Marcy Reiford. <http://www.flickr.com/photos/4x4jeepchick/331489494/> . CC BY 2.0
8. Christopher Auyeung. [CK-12 Foundation](#) . CC BY-NC 3.0
9. Christopher Auyeung. [CK-12 Foundation](#) . CC BY-NC 3.0
10. Serge Melki. <http://www.flickr.com/photos/sergemelki/3106924114/> . CC BY 2.0
11. Flickr:sunshinecity. <http://www.flickr.com/photos/sunshinecity/5437195934/> . CC BY 2.0
12. Sunflower: Greg O'Beirne (Wikimedia: Gobeirne); Plants under light: Josh Kelahan. [Sunflower](#): http://commons.wikimedia.org/wiki/File:SunflowerMountLawley2_gobeirne.jpg; [Plants under light](#): <http://www.flickr.com/photos/jdkc4d> . Sunflower: CC BY 2.5; Plants under light: CC BY 2.0
13. User:Thaddeaus/Wikimedia Commons. http://commons.wikimedia.org/wiki/File:Scottish_bonfire.jpg . Public Domain
14. Christopher Auyeung. [CK-12 Foundation](#) . CC BY-NC 3.0
15. Christopher Auyeung. [CK-12 Foundation](#) . CC BY-NC 3.0
16. Moldy bread: User:Ciar/Wikimedia Commons; Fresh bread: Jeff Keacher. [Moldy bread](#): http://commons.wikimedia.org/wiki/File:Moldy_old_bread.JPG; [Fresh bread](#): <http://www.flickr.com/photos/teuobk/2104039823/> . Moldy bread: Public Domain; Fresh bread: CC BY 2.0
17. Christopher Auyeung. [CK-12 Foundation](#) . CC BY-NC 3.0
18. Left: Flickr:thefixer; Right: Flickr:internets_dairy. [Left](#): <http://www.flickr.com/photos/fixersphotos/3199566032/>; [Right](#): <http://www.flickr.com/photos/16339684@N00/3625223334/> . CC BY 2.0

CHAPTER 9**Chemistry of Carbon****Chapter Outline**

- 9.1 PROPERTIES OF CARBON**
- 9.2 HYDROCARBONS**
- 9.3 CARBON AND LIVING THINGS**
- 9.4 BIOCHEMICAL REACTIONS**
- 9.5 REFERENCES**



The puffy white fibers on this plant look like cotton balls. In fact, that's just what they are! The plant is a cotton plant, and the white fibers enclose the seeds of the plant. The fibers are used to make cotton fabrics, so if you have a cotton T-shirt, this is where the fabric came from. Cotton fibers—and most other plant fibers—consist of one of the most common compounds on Earth, the compound named cellulose.

Cellulose is a compound found in plants. The chief component of cellulose is carbon. Cellulose is one of many carbon-based compounds that make up living things. In fact, carbon-based compounds are the most common type of compound on Earth. More than 90 percent of all known compounds contain carbon. Do you know why carbon is found in so many compounds? Read on to find out.

Flickr:Calsidyrose. www.flickr.com/photos/calsidyrose/3072355965. CC BY 2.0.

9.1 Properties of Carbon

Lesson Objectives

- Explain how carbon forms bonds.
- Define monomer and polymer.
- Describe forms of carbon.

Lesson Vocabulary

- monomer
- polymer

Introduction

Carbon is a very common "ingredient" of matter. The reason? Carbon can combine with itself and with many other elements to form a great diversity of compounds. The compounds can also range in size from just a few atoms to thousands. There are millions of known carbon compounds. Carbon is the only element that can form so many different compounds. You can find a good introduction to carbon and its chemistry at these URLs:

- <http://www.youtube.com/watch?v=HJnlNpMStbs>
- <http://www.youtube.com/watch?v=Kjn5Ht0Vn30> (9:27)



MEDIA

Click image to the left for more content.

Valence Electrons and Bonding in Carbon

Carbon is a nonmetal in group 14 of the periodic table. Like other group 14 compounds, carbon has four valence electrons. Valence electrons are the electrons in the outer energy level of an atom that are involved in chemical bonds. The valence electrons of carbon are shown in **Figure 9.1**.

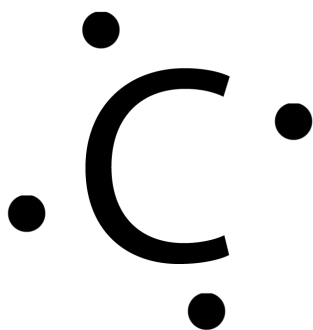

FIGURE 9.1

The dots in this diagram represent the four valence electrons of carbon.

Carbon Bonding

Because it has four valence electrons, carbon needs four more electrons to fill its outer energy level. It can achieve this by forming four covalent bonds. Covalent bonds are chemical bonds that form between nonmetals. In a covalent bond, two atoms share a pair of electrons. By forming four covalent bonds, carbon shares four pairs of electrons, thus filling its outer energy level.

A carbon atom can form bonds with other carbon atoms or with the atoms of other elements. Carbon often forms bonds with hydrogen. You can see an example in **Figure 9.2**. The compound represented in the figure is methane (CH_4). The carbon atom in a methane molecule forms bonds with four hydrogen atoms. The diagram on the left shows all the shared electrons. The diagram on the right represents each pair of shared electrons with a dash (–). This type of diagram is called a structural formula.

Electron Dot Diagram

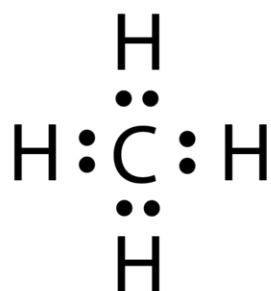

Structural Formula

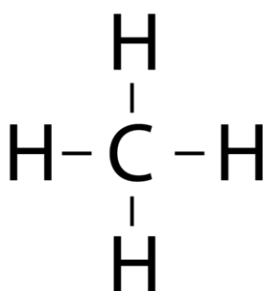

FIGURE 9.2

Methane is one of the simplest carbon compounds. At room temperature, it exists as a gas. It is a component of natural gas. These diagrams show two ways of representing the covalent bonds in methane.

How Many Bonds?

Carbon can form single, double, or even triple bonds with other carbon atoms. In a single bond, two carbon atoms share one pair of electrons. In a double bond, they share two pairs of electrons, and in a triple bond they share three pairs of electrons. Examples of compounds with these types of bonds are shown in **Figure 9.3**.

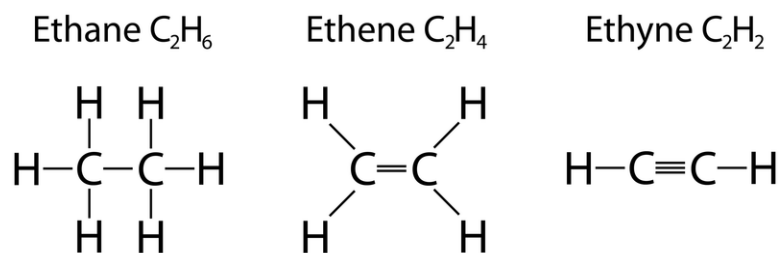

FIGURE 9.3

Carbon atoms can form single, double, or triple bonds with each other. How many bonds do the carbon atoms share in each compound shown here?

Monomers and Polymers of Carbon

Because of carbon's ability to form so many covalent bonds, it often forms polymers. A **polymer** is a large molecule that consists of many smaller molecules joined together by covalent bonds. The smaller molecules are called **monomers**. (The prefix *mono* means "one," and the prefix *poly* means "many.") Polymers may consist of just one type of monomer or of more than one type. Polymers are a little like the strings of beads in **Figure 9.4**. What do the individual beads represent?

Simple Polymer Models



FIGURE 9.4

A string of beads serves as a simple model of a polymer. Like monomers making up a polymer, the beads in a string may be all the same or different from one another.

Many polymers occur naturally. You will read about natural polymers in this chapter's "Hydrocarbons" and "Carbon and Living Things" lessons. Other polymers are synthetic. This means that they are produced in labs or factories. Synthetic polymers are created in synthesis reactions in which monomers bond together to form much larger compounds. Plastics are examples of synthetic polymers. The plastic items in **Figure 9.5** are all made of polythene (also called polyethylene). It consists of repeating monomers of ethene (C₂H₄). To learn more about polymers and how they form, go to this URL: <http://www.youtube.com/watch?v=7nCfbZwGWK8> (2:13).

**MEDIA**

Click image to the left for more content.

Items Made of Polyethylene**FIGURE 9.5**

Many common products are made of the plastic known as polyethylene.

Forms of Carbon

Pure carbon can exist in different forms, depending on how its atoms are arranged. The forms include diamond, graphite, and fullerenes. All three forms exist as crystals, but they have different structures. Their different structures, in turn, give them different properties. You can learn more about them in **Table 9.1**.

TABLE 9.1: Carbon atoms can be arranged in any of these three ways. How does the arrangement of atoms affect the properties of the substances formed?

Structure	Description	
 <p>Diamond crystal</p>	<p>Diamond</p> <p>Diamond is a form of carbon in which each carbon atom is bonded to four other carbon atoms. This forms a strong, rigid, three-dimensional structure. Diamond is the hardest natural substance. It is used for cutting and grinding tools as well as for rings and other pieces of jewelry.</p>	 <p>This metal cutter has a diamond blade.</p>

TABLE 9.1: (continued)

Structure	Description	
	<p>Graphite</p> <p>Graphite is a form of carbon in which carbon atoms are arranged in layers. Bonds are strong between carbon atoms within each layer but relatively weak between atoms in different layers. The weak bonds between layers allow the layers to slide over one another. This makes graphite relatively soft and slippery. It is used as a lubricant. It also makes up the "lead" in pencils.</p>	
	<p>Fullerene</p> <p>A fullerene (also called a buckyball) is a form of carbon in which carbon atoms are arranged in hollow spheres. Each carbon atom is bonded to three others by single covalent bonds. The pattern of atoms resembles the pattern on the surface of a soccer ball. Fullerenes were first discovered in 1985. They have been found in soot and meteorites. Possible commercial uses of fullerenes are under investigation. To learn how this form of carbon got its funny names, go to this URL: http://www.universetoday.com/83106/fullerene/ .</p>	

Lesson Summary

- Carbon is a nonmetal with four valence electrons. Each carbon atom forms four covalent bonds. Atoms of carbon can bond with each other or with atoms of other elements. The bonds may be single, double, or triple bonds.
- Because of carbon's ability to form so many covalent bonds, it often forms polymers. A polymer is a large molecule that consists of many smaller molecules, called monomers.
- Pure carbon can form different types of crystals. Crystalline forms of carbon include diamond, graphite, and fullerenes.

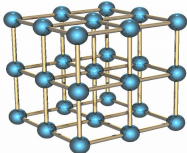
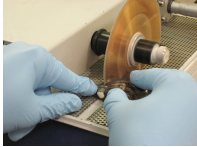
Lesson Review Questions

Recall

1. Describe the type of bonds that carbon forms.
2. How many bonds does a single carbon atom form?
3. What are polymers and monomers?
4. Name three forms of pure carbon. How do they differ?

Apply Concepts

5. A certain compound consists of two carbon atoms and two hydrogen atoms. Each carbon atom is bonded with one hydrogen atom and also with the other carbon atom. How many bonds do the two carbon atoms share? Draw the structural formula for this compound.

Think Critically

6. Explain why carbon is a component of most compounds.
7. Relate the properties of graphite and diamond to the arrangement of their atoms.

Points to Consider

The carbon compounds represented in **Figure 9.2** and **Figure 9.3** contain only carbon and hydrogen. You will read more about this type of carbon compound in the next lesson, "Hydrocarbons."

- What might be some general properties of compounds that consist only of carbon and hydrogen? (*Hint*: What is methane used for?)
- Do you know other examples of this type of compound?

9.2 Hydrocarbons

Lesson Objectives

- Define hydrocarbon.
- Describe and give examples of saturated hydrocarbons.
- Describe and give examples of unsaturated hydrocarbons.
- Identify uses and sources of hydrocarbons.

Lesson Vocabulary

- alkane
- alkene
- alkyne
- aromatic hydrocarbon
- hydrocarbon
- isomer
- saturated hydrocarbon
- unsaturated hydrocarbon

Introduction

Look at the pictures in **Figure 9.6**. Each one shows an item that you might have used or seen used by someone else. All of the items have something in common. Can you guess what it is? They all depend on carbon compounds known as hydrocarbons.

What Are Hydrocarbons?

Hydrocarbons are compounds that contain only carbon and hydrogen. Hydrocarbons are the simplest type of carbon-based compounds. Nonetheless, they can vary greatly in size. The smallest hydrocarbons have just one or two carbon atoms, but large hydrocarbons may have hundreds. The size of hydrocarbon molecules influences their properties. For example, it influences their boiling and melting points. As a result, some hydrocarbons are gases at room temperature, while others are liquids or solids. Hydrocarbons are generally nonpolar and do not dissolve in water. In fact, they tend to repel water. That's why they are used in floor wax and similar products.

Hydrocarbons can be classified in two basic classes. The classes are saturated hydrocarbons and unsaturated hydrocarbons. This classification is based on the number of bonds between carbon atoms. You can learn more about both types of hydrocarbons at this URL: <http://www.youtube.com/watch?v=19ZieYdLwfo> (6:41).



A canister of the hydrocarbon named propane provides fuel for this camp stove.



This lawnmower runs on a mixture of hydrocarbons commonly named gasoline.

FIGURE 9.6

Each of these pictures shows a use of hydrocarbons.



The main ingredient in nail polish remover is a hydrocarbon named acetone. Acetone is also found in paint thinner.



The strongly scented vapor given off by mothballs repels insects. The main ingredient of mothballs is a hydrocarbon named naphthalene.

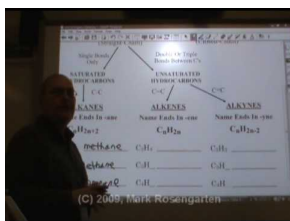

MEDIA

Click image to the left for more content.

Saturated Hydrocarbons

Saturated hydrocarbons contain only single bonds between carbon atoms. They are the simplest hydrocarbons. They are called saturated because each carbon atom is bonded to as many hydrogen atoms as possible. In other words, the carbon atoms are saturated with hydrogen. You can see an example of a saturated hydrocarbon in **Figure 9.7**. Each carbon atom is bonded to three hydrogen atoms in this compound, which is named ethane.

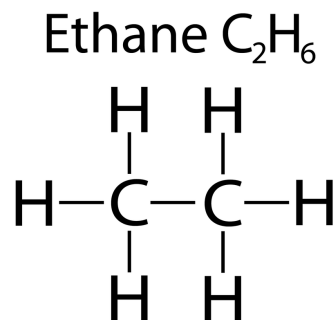

FIGURE 9.7

Ethane is a saturated hydrocarbon. What is its chemical formula?

Saturated hydrocarbons are given the general name of **alkanes**. The name of specific alkanes always ends in *-ane*. The first part of the name indicates how many carbon atoms each molecule of the alkane has. The smallest alkane is methane. It has just one carbon atom. The next largest is ethane, with two carbon atoms. The chemical formulas and properties of methane, ethane, and several other alkanes are listed in **Table 9.2**. The boiling and melting points of alkanes are determined mainly by the number of carbon atoms they have. Alkanes with more carbon atoms generally have higher boiling and melting points.

This table shows only alkanes with relatively few carbon atoms. Some alkanes have many more carbon atoms. What properties might larger alkanes have? For example, do you think that any of them might be solids?

TABLE 9.2: Small Alkanes

Alkane	Chemical Formula	Boiling Point (°C)	Melting Point (°C)	State (at 20°C)
Methane	CH ₄	-162	-183	gas
Ethane	C ₂ H ₆	-89	-172	gas
Propane	C ₃ H ₈	-42	-188	gas
Butane	C ₄ H ₁₀	0	-138	gas
Pentane	C ₅ H ₁₂	36	-130	liquid
Hexane	C ₆ H ₁₄	69	-95	liquid
Heptane	C ₇ H ₁₆	98	-91	liquid
Octane	C ₈ H ₁₈	126	-57	liquid

Shapes of Alkanes

Structural formulas are often used to represent hydrocarbon compounds because the molecules can have different shapes, or structures. Hydrocarbons may form straight chains, branched chains, or rings. **Figure 9.8** shows an example of an alkane with each shape.

- In straight-chain molecules, all the carbon atoms are lined up in a row like cars of a train. They form what is called the backbone of the molecule.

- In branched-chain molecules, at least one of the carbon atoms branches off to the side from the backbone.
- In cyclic molecules, the chain of carbon atoms is joined at the two ends to form a ring.

Straight-chain alkane

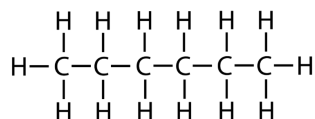

Branched-chain alkane

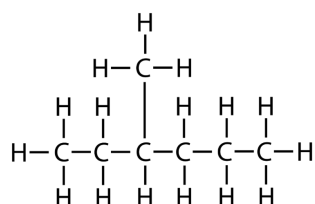

Cyclic alkane

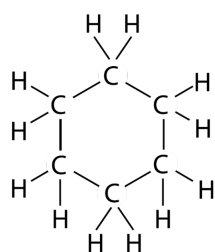

FIGURE 9.8

Alkanes may have any of these three shapes.

Isomers

Even compounds with the same number of carbon and hydrogen atoms can have different shapes. These compounds are called **isomers**. Look at the examples in **Figure 9.9**. The figure shows the structural formulas of butane and its isomer *iso*-butane. Both molecules have four carbon atoms and ten hydrogen atoms (C_4H_{10}), but the atoms are arranged differently. Butane is a straight-chain molecule. *Is*-butane is branched. You can see three-dimensional models of these two isomers at the URLs below. You can rotate the molecule models to get a better idea of their shapes.

http://www.worldofmolecules.com/3D/butane_3d.htm

<http://www.chemspider.com/Chemical-Structure.6120.html>

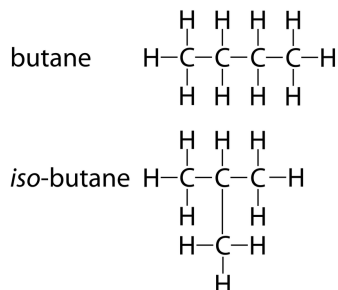

FIGURE 9.9

Butane and isobutane have the same atoms but different shapes.

Isomers usually have somewhat different properties. For example, straight-chain molecules generally have higher boiling and melting points than their branched-chain isomers. The boiling and melting points of *iso*-butane are -12°C and -160°C , respectively. Compare these values with the boiling and melting points of butane in **Table 9.2**. Do these two compounds follow the general trend?

Cycloalkanes

Ring-shaped alkanes are called cycloalkanes. They usually contain just five or six carbon atoms because larger rings are not very stable. However, rings can join together to create larger molecules consisting of two or more rings. Compared with the straight- and branched-chain alkanes, cycloalkanes have higher boiling and melting points.

Unsaturated Hydrocarbons

Unsaturated hydrocarbons contain at least one double or triple bond between carbon atoms. As a result, the carbon atoms are unable to bond with as many hydrogen atoms as they would if they were joined only by single bonds. This makes them unsaturated with hydrogen. Unsaturated hydrocarbons are classified on the basis of their bonds as alkenes, alkynes, or aromatic hydrocarbons.

Alkenes

Unsaturated hydrocarbons that contain at least one double bond are called **alkenes**. The name of a specific alkene always ends in *-ene*, with a prefix indicating the number of carbon atoms. **Figure 9.10** shows the structural formula for the smallest alkene. It has just two carbon atoms and is named ethene. Ethene is produced by most fruits and vegetables. It speeds up ripening and also rotting. **Figure 9.11** shows the effects of ethene on bananas.

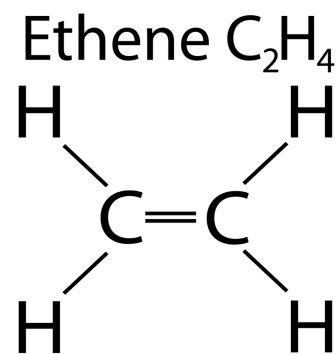

FIGURE 9.10
Ethene is the smallest alkene.

Like alkanes, alkenes can have different shapes. They can form straight chains, branched chains, or rings. Alkenes can also form isomers, or compounds with the same atoms but different shapes. Generally, the physical properties of alkenes are similar to those of alkanes. Smaller alkenes, such as ethene, have relatively high boiling and melting points. They are gases at room temperature. Larger alkenes have lower boiling and melting points. They are liquids or waxy solids at room temperature.

Alkynes

Unsaturated hydrocarbons that contain at least one triple bond are called **alkynes**. The name of specific alkynes always end in *-yne*, with a prefix for the number of carbon atoms. **Figure 9.12** shows the smallest alkyne, called

**FIGURE 9.11**

These two bunches of bananas were stored in different ways. The bananas on the right were stored in the open air. The bananas on the left were stored in a special bag that absorbs the ethene they release. The bananas in the bag have not yet turned brown because they were not exposed to ethene.

ethyne, which has just two carbon atoms. Ethyne is also called acetylene. It is burned in acetylene torches, like the one in **Figure 9.13**. Acetylene produces so much heat when it burns that it can melt metal. Breaking all those bonds between carbon atoms releases a lot of energy.

Ethyne C_2H_2

**FIGURE 9.12**

Ethyne is the smallest alkyne.

**FIGURE 9.13**

This acetylene torch is being used to cut metal.

Alkynes may form straight or branched chains. They rarely occur as cycloalkynes. In fact, alkynes of all shapes are relatively rare, at least in nature.

Aromatic Hydrocarbons

Unsaturated cyclic hydrocarbons are called **aromatic hydrocarbons**. That's because they have a strong aroma, or scent. Their molecules consist of six carbon atoms in a ring shape, connected by alternating single and double bonds. Aromatic hydrocarbons may have a single ring or multiple rings joined together by bonds between their carbon atoms.

Benzene is the smallest aromatic hydrocarbon. It has just one ring. You can see its structural formula in **Figure 9.14**. Benzene has many uses. For example, it is used in air fresheners and mothballs because of its strong scent.

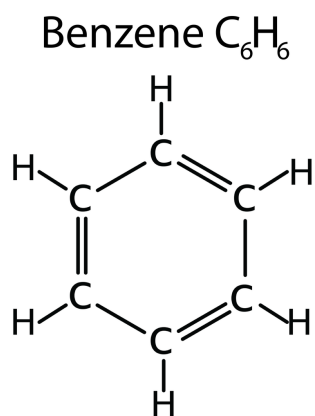
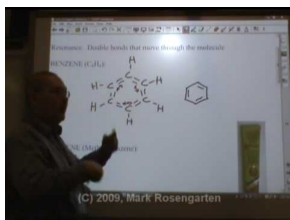

FIGURE 9.14

Benzene is an aromatic hydrocarbon. Does each carbon atom in benzene have a total of four bonds? Count them to find out.

You can learn more about benzene and other aromatic hydrocarbons at this URL: <http://www.youtube.com/watch?v=8gW7H0ReN5g> (4:54).



MEDIA

Click image to the left for more content.

Uses and Sources of Hydrocarbons

It is hard to overstate the importance of hydrocarbons to modern life. Hydrocarbons have even been called the driving force of western civilization. You saw some ways they are used in **Figure 9.6**. Several other ways are illustrated in **Figure 9.15**. Their most important use is as fuels. Gasoline, natural gas, fuel oil, diesel fuel, jet fuel, coal, kerosene, and propane are just some of the hydrocarbon compounds that are burned for fuel. Hydrocarbons are also used to manufacture many products, including plastics and synthetic fabrics such as polyester.

The main source of hydrocarbons is fossil fuels —coal, petroleum, and natural gas. Fossil fuels form over hundreds of millions of years when dead organisms are covered with sediments and put under great pressure. Giant ferns in ancient swamps turned into coal deposits. Dead organisms in ancient seas gradually formed deposits of petroleum and natural gas. You can read more about these sources of hydrocarbons in the chapter *Introduction to Energy* and at the URL below.

<http://www.energyquest.ca.gov/story/chapter08.html>

Asphalt pavement on highways is made of hydrocarbons found in petroleum.



This fireplace lighter burns the alkane named butane.

Motor oil consists of several hydrocarbons. It lubricates the moving parts of car engines.



Many candles are made of paraffin wax, a solid mixture of alkanes.

These synthetic rubber boots are made mainly of a mixture of alkenes.



All of these forms of transportation are fueled by a mixture of many hydrocarbons.



This power plant burns the hydrocarbons in coal. A large pile of coal is conveniently located next to this power plant.

FIGURE 9.15

These photos show just a few of the many uses of hydrocarbons.

Lesson Summary

- Hydrocarbons are compounds that contain only carbon and hydrogen. They are the simplest type of carbon-based compounds.
- Saturated hydrocarbons contain only single bonds between carbon atoms. They are also called alkanes. They may form straight-chain, branched-chain, or cyclic molecules. Compounds with the same number of atoms but different shapes are called isomers.
- Unsaturated hydrocarbons contain at least one double or triple bond between carbon atoms. Hydrocarbons with double bonds are called alkenes. Those with triple bonds are called alkynes. Aromatic hydrocarbons consist of six carbon atoms in a ring shape, connected by alternating single and double bonds.
- Hydrocarbons are extremely important to modern life. Their most important use is as fuels. Hydrocarbons are also used to manufacture many products including plastics. The main source of hydrocarbons is fossil fuels.

Lesson Review Questions

Recall

1. What are hydrocarbons?
2. Describe how the boiling point of alkanes changes as the number of carbon atoms per molecule increases.
3. Identify and describe the three basic shapes of alkane molecules.
4. What are isomers?
5. Define alkene and alkyne.
6. Describe aromatic hydrocarbons.

Apply Concepts

7. Which type of hydrocarbon is represented by this structural formula? What is the compound's chemical formula? What shape does it have?

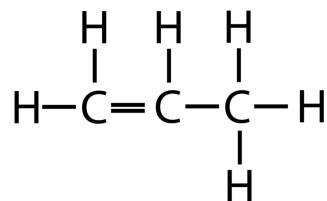

Think Critically

8. Compare and contrast saturated and unsaturated hydrocarbons. Give an example of each.
9. Explain the relationship between plastics and fossil fuels.

Points to Consider

In this lesson, you read that fossil fuels form from the remains of dead organisms. As you will read in the next lesson, "Carbon and Living Things," organisms are made of carbon-based compounds.

- Do you know the names of any of the carbon compounds in living things? (*Hint:* Many of them are found in food.)
- How might these carbon compounds be different from hydrocarbons?

9.3 Carbon and Living Things

Lesson Objectives

- Give an overview of biochemical compounds.
- Identify the structure and functions of carbohydrates.
- Describe protein structure, and list functions of proteins.
- Outline the structure and functions of lipids.
- Identify the structure of nucleic acids and their functions.

Lesson Vocabulary

- biochemical compound
- carbohydrate
- lipid
- nucleic acid
- protein

Introduction

Carbon is the most important element in living things. Carbon-based compounds in living things are generally called biochemical compounds. The prefix *bio* comes from the Greek word that means "life." Many of the same biochemical compounds are found in all forms of life, despite life's great diversity.

Biochemical Compounds

A **biochemical compound** is any carbon-based compound found in living things. Like hydrocarbons, all biochemical compounds contain hydrogen as well as carbon. However, biochemical compounds also contain other elements, such as oxygen and nitrogen. Almost all biochemical compounds are polymers. They consist of many, smaller monomer molecules. Biochemical polymers are referred to as macromolecules. The prefix *macro* means "large," and many biochemical molecules are very large indeed. They may contain thousands of monomer molecules.

Biochemical compounds make up the cells and tissues of organisms. They are also involved in life processes, such as making and using food for energy. Given their diversity of functions, it's not surprising that there are millions of different biochemical compounds. However, they can be grouped into just four main classes: carbohydrates, proteins, lipids, and nucleic acids. The classes are summarized in **Table 9.3** and described in the rest of this lesson.

TABLE 9.3: Classes of Biochemical Compounds

Class	Elements	Examples	Functions
Carbohydrates	carbon hydrogen oxygen	sugars starches cellulose	provide energy to cells store energy in plants makes up the cell walls of plants
Proteins	carbon hydrogen oxygen nitrogen sulfur	enzymes hormones	speed up biochemical reactions regulate life processes
Lipids	carbon hydrogen oxygen	fats oils	store energy in animals store energy in plants
Nucleic acids	carbon hydrogen oxygen nitrogen phosphorus	DNA RNA	stores genetic information in cells helps cells make proteins

Carbohydrates

Carbohydrates are biochemical compounds that include sugars, starches, and cellulose. They contain oxygen in addition to carbon and hydrogen. Organisms use carbohydrates mainly for energy.

Sugars

Sugars are simple carbohydrates. Molecules of sugar have just a few carbon atoms. The simplest sugar is glucose ($C_6H_{12}O_6$). Glucose is the sugar that the cells of living things use for energy. Plants and some other organisms make glucose in the process of photosynthesis. Living things that cannot make glucose obtain it by consuming plants or these other organisms.

You can see the structural formula of glucose and two other sugars in **Figure 9.16**. The other sugars in the figure are fructose and sucrose. Fructose is an isomer of glucose. It is found in fruits. It has the same atoms as glucose, but they are arranged differently. Sucrose is table sugar. It consists of one molecule of glucose and one molecule of fructose.

Starches

Starches are complex carbohydrates. They are polymers of glucose. They consist of hundreds of glucose monomers bonded together. Plants make starch to store extra sugars. Consumers get starch from plants. Common sources of starch in the human diet are pictured in **Figure 9.17**. Our digestive system breaks down starch to simple sugars, which our cells use for energy.

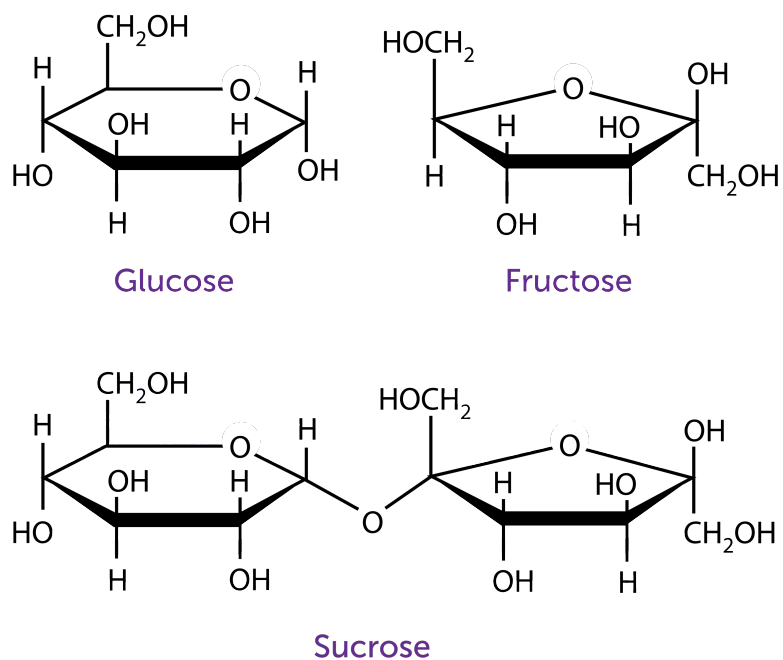
**FIGURE 9.16**

Glucose and fructose are isomers. Sucrose contains a molecule of each.

Foods that are Good Sources of Starches

Potatoes



Cereal



Pasta



Bread

**FIGURE 9.17**

These foods are all good sources of starch.

Cellulose

Cellulose is another complex carbohydrate that is a polymer of glucose. However, the glucose molecules are bonded together differently in cellulose than they are in starches. Cellulose molecules bundle together to form long, tough

fibers (see **Figure 9.18**). Have you ever eaten raw celery? If you have, then you probably noticed that the stalks contain long, stringy fibers. The fibers are mostly cellulose.

Cellulose is the most abundant biochemical compound. It makes up the cell walls of plants and gives support to trunks and stems. Cellulose also provides needed fiber in the human diet. We can't digest cellulose, but it helps keep food wastes moving through the digestive tract.

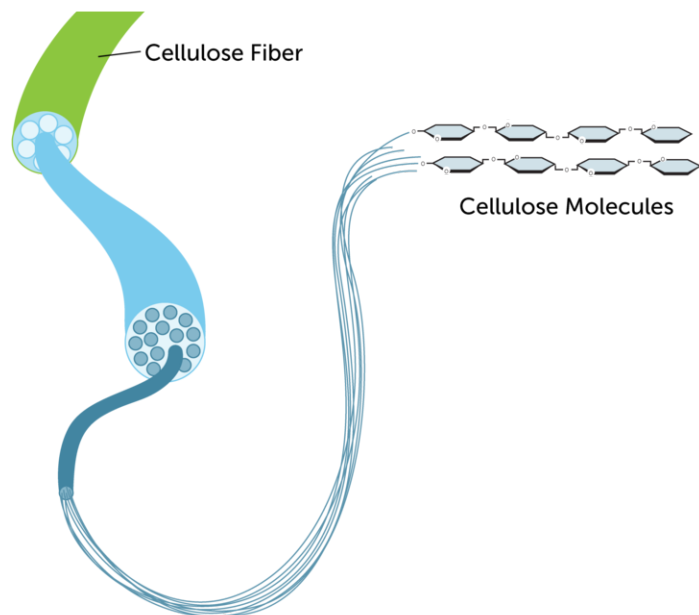
**FIGURE 9.18**

Cellulose molecules form large cellulose fibers.

Proteins

Proteins are biochemical compounds that contain oxygen, nitrogen, and sulfur in addition to carbon and hydrogen. Protein molecules consist of one or more chains of small molecules called amino acids.

Protein Structure

Amino acids are the "building blocks" of proteins. There are 20 different common amino acids. The structural formula of the simplest amino acid, called glycine, is shown in **Figure 9.19**. Other amino acids have a similar structure. The sequence of amino acids and the number of amino acid chains in a protein determine the protein's shape. The shape of a protein, in turn, determines its function. Shapes may be very complex. You can learn more about the structure of proteins at the URL below.

<http://www.youtube.com/watch?v=lijQ3a8yUYQ> (0:52)

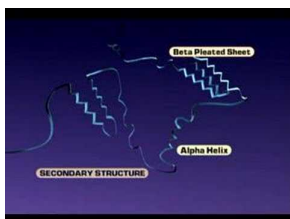

MEDIA

Click image to the left for more content.

Glycine

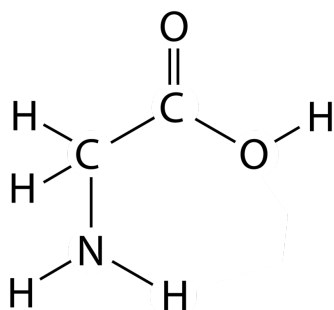

FIGURE 9.19

Glycine is one of 20 common amino acids that make up the proteins of living things.

Protein Functions

Proteins are the most common biochemicals. They have many different functions, including:

- making up tissues as components of muscle.
- speeding up biochemical reactions as enzymes.
- regulating life processes as hormones.
- helping defend against infections as antibodies.
- transporting materials as components of the blood (see the example in **Figure 9.20**).

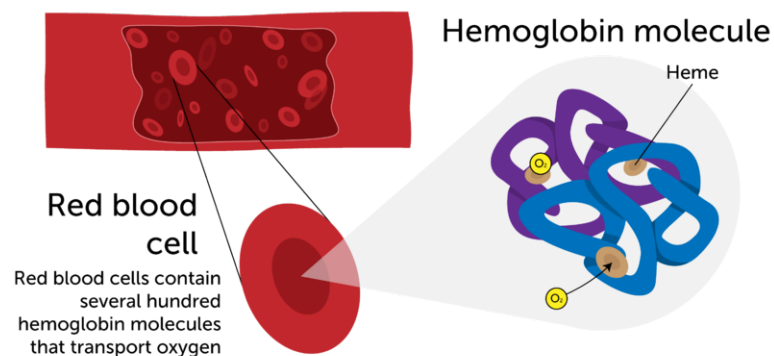

FIGURE 9.20

The blood protein hemoglobin binds with oxygen and carries it from the lungs to cells throughout the body. Heme is a small molecule containing iron that is part of the larger hemoglobin molecule. Oxygen binds to the iron in heme.

Lipids

Lipids are biochemical compounds such as fats and oils. Organisms use lipids to store energy. In addition to carbon and hydrogen, lipids contain oxygen.

Fatty Acids

Lipids are made up of long carbon chains called fatty acids. Like hydrocarbons, fatty acids may be saturated or unsaturated. **Figure 9.21** shows structural formulas for two small fatty acids. One is saturated and one is unsaturated.

- In saturated fatty acids, there are only single bonds between carbon atoms. As a result, the carbons are saturated with hydrogen atoms. Saturated fatty acids are found in fats. Fats are solid lipids that animals use to store energy.
- In unsaturated fatty acids, there is at least one double bond between carbon atoms. As a result, some carbons are not bonded to as many hydrogen atoms as possible. Unsaturated fatty acids are found in oils. Oils are liquid lipids that plants use to store energy.

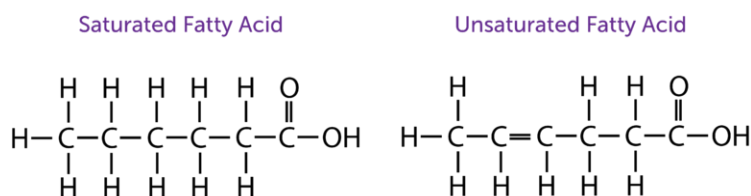

FIGURE 9.21

Both of these fatty acid molecules have six carbon atoms and two oxygen atoms. How many hydrogen atoms does each fatty acid have?

Phospholipids

Some lipids contain the element phosphorus as well as oxygen, carbon, and hydrogen. These lipids are called phospholipids. Two layers of phospholipid molecules make up most of the cell membrane in the cells of living things.

Figure 9.22 shows how phospholipid molecules are arranged in a cell membrane. One end (the head) of each phospholipid molecule is polar and attracts water. This end is called hydrophilic ("water loving"). The other end (the tail) is nonpolar and repels water. This end is called hydrophobic ("water hating"). The nonpolar tails are on the inside of the membrane. The polar heads are on the outside of the membrane. These differences in polarity allow some molecules to pass through the membrane while keeping others out. You can see how this works in the video at the URL below.

<http://www.beyondbooks.com/lif71/4b.asp>

Nucleic Acids

Nucleic acids are biochemical molecules that contain oxygen, nitrogen, and phosphorus in addition to carbon and hydrogen. There are two main types of nucleic acids. They are DNA (deoxyribonucleic acid) and RNA (ribonucleic acid).

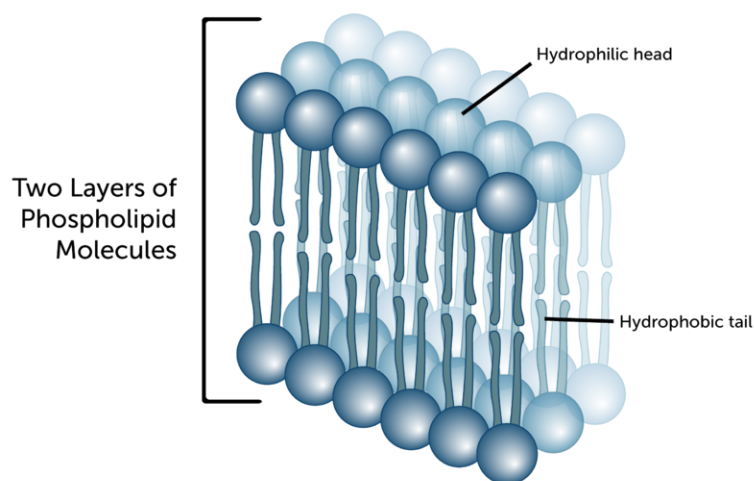

FIGURE 9.22

The arrangement of phospholipid molecules in a cell membrane allows the membrane to control what enters and leaves the cell.

Structure of Nucleic Acids

Nucleic acids consist of chains of small molecules called nucleotides. The structure of a nucleotide is shown in **Figure 9.23**. Each nucleotide contains a phosphate group (PO_4), a sugar ($\text{C}_5\text{H}_8\text{O}_4$) in DNA, and a nitrogen-containing base. (A base is a compound that is not neither acidic nor neutral.) There are four different nitrogenous bases in DNA. They are adenine, thymine, guanine, and cytosine. In RNA, the only difference is that thymine is replaced with a different base, uracil.

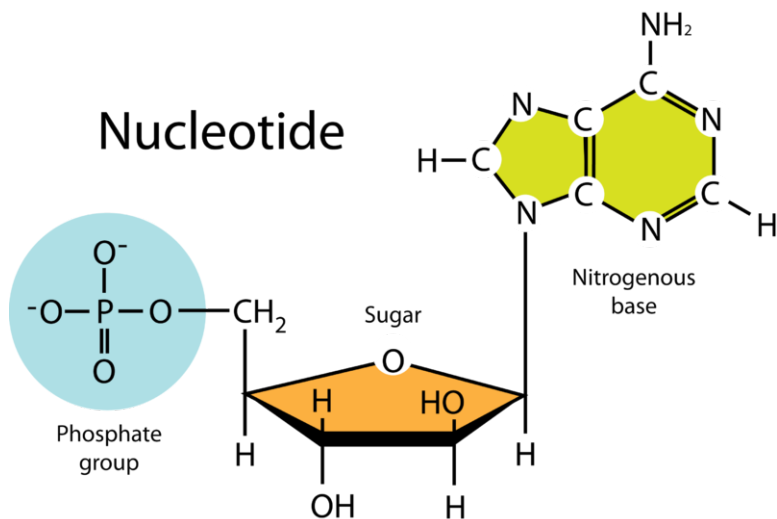

FIGURE 9.23

Each nucleotide contains these three components.

DNA consists of two long chains of nucleotides. Nitrogen bases on the two chains form hydrogen bonds with each other. Adenine always bonds with thymine, and guanine always bonds with cytosine. These bonds hold the two chains together and give DNA its characteristic double helix, or spiral, shape. You can see the shape of the DNA molecule in **Figure 9.24**. Sugars and phosphate groups form the "backbone" of each chain of DNA. The bonded bases are called base pairs. RNA, in contrast to DNA, consists of just one chain of nucleotides. Determining the structure of DNA was a big scientific breakthrough. You can read the interesting story of its discovery at the URL below.

http://nobelprize.org/educational/medicine/dna_double_helix/readmore.html

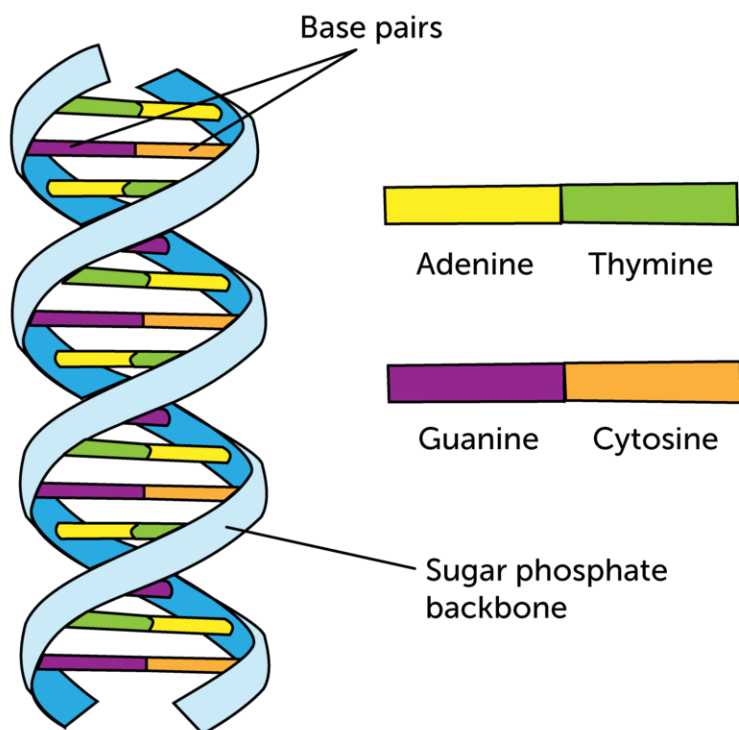
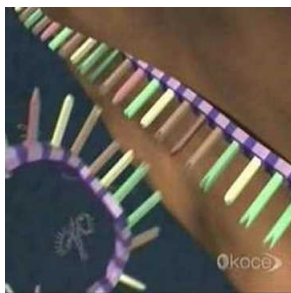

FIGURE 9.24

DNA has the shape of a double helix because of hydrogen bonds between nitrogen bases.

Functions of Nucleic Acids

DNA stores genetic information in the cells of all living things. It contains the genetic code. This is the code that instructs cells how to make proteins. The instructions are encoded in the sequence of nitrogen bases in the nucleotide chains of DNA. RNA "reads" the genetic code in DNA and is involved in the synthesis of proteins based on the code. This video shows how: <http://www.youtube.com/watch?v=NJxobgkPEAo> (2:51).



MEDIA

Click image to the left for more content.

Lesson Summary

- A biochemical compound is any carbon-based compound found in living things. Most biochemical compounds are polymers that contain oxygen, nitrogen, or other elements in addition to carbon and hydrogen.

- Carbohydrates are biochemical compounds that include sugars, starches, and cellulose. Their functions include providing or storing energy and making up plant cell walls.
- Proteins are biochemical compounds that consist of one or more chains of amino acids. Proteins have many different functions. For example, some are enzymes, and some are hormones.
- Lipids are biochemical compounds such as fats and oils. They consist of fatty acids, which may be saturated or unsaturated. Lipids are used to store energy. They also make up cell membranes.
- Nucleic acids are biochemical compounds that include DNA and RNA. They consist of chains of smaller molecules called nucleotides. DNA stores the genetic code for proteins. RNA helps make proteins.

Lesson Review Questions

Recall

1. Name the four classes of biochemical compounds.
2. What are sugars and starches? How are they used?
3. Describe the structure of proteins. List three functions of proteins.
4. Describe the structure of nucleic acids. What components are found in each nucleotide?

Apply Concepts

5. A mystery biochemical compound contains only carbon, hydrogen, and oxygen. It is made by both plants and animals. In which class of biochemical compounds should it be placed?

Think Critically

6. Use structural formulas to illustrate the difference between fatty acids in oils and fatty acids in fats.
7. Explain the relationship between DNA and RNA.

Points to Consider

Biochemical compounds are involved in almost all life processes. One of the most important life processes is photosynthesis.

- What is photosynthesis?
- Why is photosynthesis so important to living things?

9.4 Biochemical Reactions

Lesson Objectives

- Describe photosynthesis.
- Outline cellular respiration.
- Explain the role of enzymes in biochemical reactions.

Lesson Vocabulary

- cellular respiration
- enzyme
- photosynthesis

Introduction

All living things need energy. From running a marathon to just taking a breath, energy is required. Where does the energy come from? The answer is chemical reactions. Reactions that take place within living things are called biochemical reactions. Two of the most important are photosynthesis and cellular respiration. Together, these two processes provide energy to almost all of Earth's organisms. **Figure 9.25** and the video at the URL below show how the two processes are related.

<http://www.youtube.com/watch?v=NJxobgkPEAo>

Photosynthesis

Most of the energy used by living things comes either directly or indirectly from the sun. Sunlight provides the energy for **photosynthesis**. This is the process in which plants and certain other organisms (see **Figure 9.26**) synthesize glucose (C₆H₁₂O₆). The process uses carbon dioxide and water and also produces oxygen. The overall chemical equation for photosynthesis is:

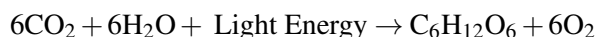

Photosynthesis changes light energy to chemical energy. The chemical energy is stored in the bonds of glucose molecules. Glucose is used for energy by the cells of almost all living things. Plants make their own glucose. Other organisms get glucose by consuming plants (or organisms that consume plants). How do living things get energy from glucose? The answer is cellular respiration.

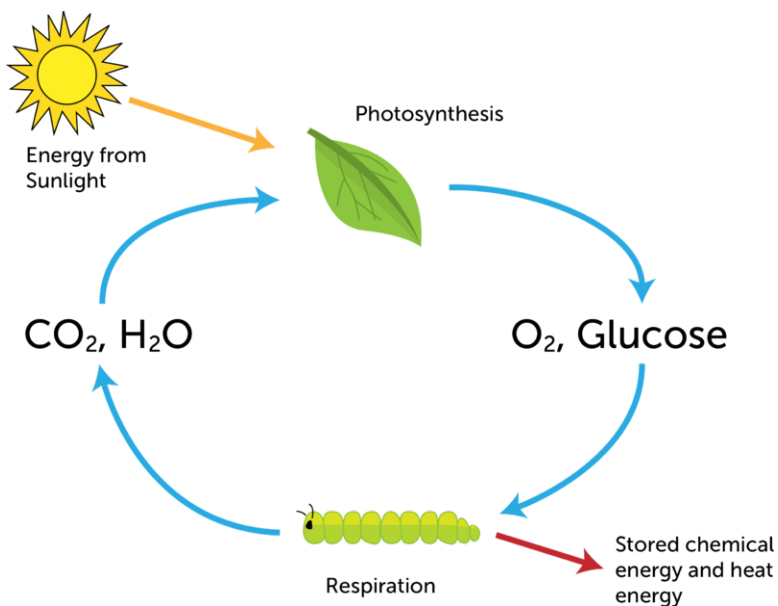

FIGURE 9.25

Photosynthesis and cellular respiration are closely related. What are the products and reactants of each process?



The green streaks in this dark blue lake are photosynthetic bacteria called cyanobacteria.



The green "scum" on this pond consists of photosynthetic algae.



All plants make glucose by photosynthesis—even these pitcher plants, which use their "pitchers" to capture and digest insects for extra nutrients.

FIGURE 9.26

These organisms use sunlight to make glucose in the process of photosynthesis. All of them contain the green pigment chlorophyll, which is needed to capture light energy.

Cellular Respiration

Cellular respiration is the process in which the cells of living things break down glucose with oxygen to produce carbon dioxide, water, and energy. The overall chemical equation for cellular respiration is:

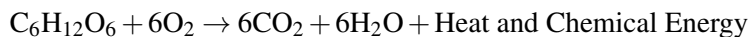

Cellular respiration releases some of the energy in glucose as heat. It uses the rest of the energy to form many, even smaller molecules. The smaller molecules contain just the right amount of energy to power chemical reactions inside cells. You can look at cellular respiration in more detail at this URL: <http://www.youtube.com/watch?v=JyMfKP1D7OE> (12:38).

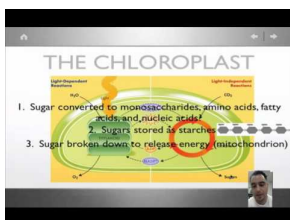

MEDIA

Click image to the left for more content.

Enzymes and Biochemical Reactions

Human body temperature must remain within a narrow range around 37°C (98.6°F). At this temperature, most biochemical reactions would occur too slowly to keep us alive. That's where enzymes come in. **Enzymes** are biochemical catalysts. They speed up biochemical reactions, not only in humans but in virtually all living things. Most enzymes are proteins. Two are described in **Figure 9.27**.

Lesson Summary

- Biochemical reactions are chemical reactions that take place inside living things. Two of the most important biochemical reactions are photosynthesis and cellular respiration.
- Photosynthesis is the process in which plants and certain other organisms synthesize glucose from carbon dioxide and water using light energy. Oxygen is also produced.
- Cellular respiration is the process in which the cells of living things break down glucose with oxygen to produce carbon dioxide, water, and energy.
- Enzymes are biochemical catalysts that speed up biochemical reactions. Without enzymes, most chemical reactions in living things would occur too slowly to keep organisms alive.

Lesson Review Questions

Recall

1. What is photosynthesis? Write the overall chemical equation for this process.



Digestion begins in the mouth. The enzyme amylase in saliva catalyzes the breakdown of starches into sugars.

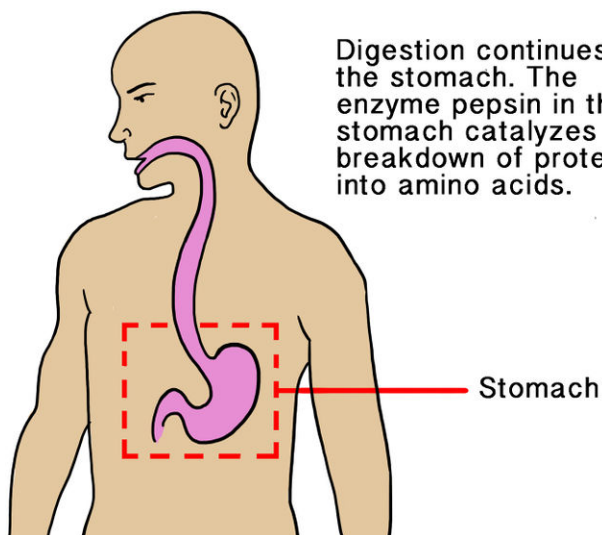

Digestion continues in the stomach. The enzyme pepsin in the stomach catalyzes the breakdown of proteins into amino acids.

FIGURE 9.27

The human body produces many enzymes that help digest food. Here are just two examples.

2. What types of organisms undergo photosynthesis?
3. What is cellular respiration? Write the overall chemical equation for this process.
4. Define enzyme, and give an example.

Apply Concepts

5. Create a cycle diagram to show how photosynthesis and cellular respiration are related.

Think Critically

6. Classify photosynthesis and cellular respiration as endothermic or exothermic reactions. Explain your classification.

Points to Consider

The enzyme pepsin works only in the presence of acid. A strong acid is secreted into the stomach. It provides the acid that pepsin needs. You will learn about acids in the next chapter, "Chemistry of Solutions." Vinegar and lemon

juice are two common acids.

- What do you think are properties of acids?
- What other foods might contain acids?

For **Table 9.1**,

- Lattice: User:Cadmium/Wikipedia. http://commons.wikimedia.org/wiki/File:Alpha_po_lattice.jpg . Public Domain.
- Metal saw: Courtesy of U.S. Fish and Wildlife Service Southeast Region. <http://www.flickr.com/photos/usfws/southeast/5544032939> . CC BY 2.0.
- Graphite structure: Laura Guerin. CK-12 Foundation. CC BY-NC 3.0.
- Lubricant: K. Murray. http://commons.wikimedia.org/wiki/File:Graphite_spray_paint.jpg . Public Domain.
- Fullerene: User:Jynto/Wikimedia Commons. <http://commons.wikimedia.org/wiki/File:Buckminsterfullerene-3D-balls.png> . Public Domain.

9.5 References

1. Christopher Auyeung. [CK-12 Foundation](#) . CC BY-NC 3.0
2. Christopher Auyeung. [CK-12 Foundation](#) . CC BY-NC 3.0
3. Jodi So. [CK-12 Foundation](#) . CC BY-NC 3.0
4. Left: Andy Mabbett; Right: Shira Gal. Left: <http://www.flickr.com/photos/pigsonthewing/3759031231/>; Right: http://www.flickr.com/photos/miss_pupik/2166483888/ . CC BY 2.0
5. Milk: www.bluewaikiki.com; Plastic bag: Ralph Aichinger; Toys: Kannan Shanmugam. Milk: <http://www.flickr.com/photos/lfl/2132323232/>; Plastic bag: <http://www.flickr.com/photos/sooperkuh/4310498162/>; Toys: http://commons.wikimedia.org/wiki/File:Chinese_plastic_toys6.JPG . Milk and Plastic bag: CC BY 2.0; Toys: CC BY 3.0
6. Camping stove: Tom Check; Lawn mower: Flickr:Combsy; Nail polish remover: Joy Sheng; Moth ball: Christopher Auyeung. Camping stove: http://commons.wikimedia.org/wiki/File:Pine_Needle_Tea.jpg; Lawn mower: <http://www.flickr.com/photos/combsy/4452483092/>; Nail polish remover and Moth ball: [CK-12 Foundation](#) . Camping stove and Lawn mower: CC BY 2.0; Nail polish remover and Moth ball: CC BY-NC 3.0
7. Jodi So. [CK-12 Foundation](#) . CC BY-NC 3.0
8. Christopher Auyeung. [CK-12 Foundation](#) . CC BY-NC 3.0
9. Jodi So. [CK-12 Foundation](#) . CC BY-NC 3.0
10. Jodi So. [CK-12 Foundation](#) . CC BY-NC 3.0
11. Good bananas: Image copyright Sally Scott, 2013; Bad bananas: Image copyright PeJo, 2013. <http://www.shutterstock.com> . Used under licenses from Shutterstock.com
12. Jodi So. [CK-12 Foundation](#) . CC BY-NC 3.0
13. Jason Kaechler. <http://www.flickr.com/photos/kaechler/2279074928/> . CC BY 2.0
14. Jodi So. [CK-12 Foundation](#) . CC BY-NC 3.0
15. Asphalt: User:Shoecream/Wikipedia; Lighter: Rodrigo Amorim; Motor Oil: Interior, retouched by Where next Columbus?, brand name removed by H Padleckas; Candle: Armin Vogel; Boots: Frank C. Müller; Vehicles: Laura Guerin (CK-12 Foundation); Power plant: Flickr:massmatt. Asphalt: http://commons.wikimedia.org/wiki/File:Raised_pavement_marker.jpg; Lighter: <http://www.flickr.com/photos/zetotal/3795447697/>; Motor Oil: http://commons.wikimedia.org/wiki/File:Motor_oil.JPG; Candle: <http://www.flickr.com/photos/63019370@N06/6714178943/>; Boots: http://commons.wikimedia.org/wiki/File:Gummistiefel_bunt_fcm.jpg; Power plant: <http://www.flickr.com/photos/momentsnotice/9636507469/> . Asphalt: Public Domain; Lighter: CC BY 2.0; Motor Oil: Public Domain; Candle: CC BY 2.0; Boots: Public Domain; Vehicles: CC BY-NC 3.0; Power plant: CC BY 2.0
16. Christopher Auyeung. [CK-12 Foundation](#) . CC BY-NC 3.0
17. Bread: Bart Everson (Flickr:Editor B); Pasta: Mathias Biaux; Cereal: Borja Iza; Potatoes: Courtesy of Scott Bauer/U.S. Department of Agriculture and the ARS. Bread: <http://www.flickr.com/photos/editor/8311347461/>; Pasta: http://commons.wikimedia.org/wiki/File:Picture_246_w.jpg; Cereal: http://commons.wikimedia.org/wiki/File:Spoonful_of_cereal.jpg; Potatoes: <http://commons.wikimedia.org/wiki/File:Potatoes.jpg> . Bread: CC BY 2.0; Pasta, Cereal, Potatoes: Public Domain
18. Christopher Auyeung. [CK-12 Foundation](#) . CC BY-NC 3.0
19. Christopher Auyeung. [CK-12 Foundation](#) . CC BY-NC 3.0
20. Christopher Auyeung. [CK-12 Foundation](#) . CC BY-NC 3.0
21. Christopher Auyeung. [CK-12 Foundation](#) . CC BY-NC 3.0
22. Christopher Auyeung. [CK-12 Foundation](#) . CC BY-NC 3.0
23. Christopher Auyeung. [CK-12 Foundation](#) . CC BY-NC 3.0
24. Forluvoft, modified by Christopher Auyeung/CK-12 Foundation. http://commons.wikimedia.org/wiki/File:DNA_simple2.svg . Public Domain

25. Christopher Auyeung. [CK-12 Foundation](#) . CC BY-NC 3.0
26. Blue lake: Courtesy of NASA Earth Observatory; Algae pond: Dwight Burdette; Pitcher plant: Geoff Gallice (Flickr:ggalice). Blue lake: http://commons.wikimedia.org/wiki/File:Harmful_Bloom_in_Lake_Atitlan,_Guatemala.jpg; Algae pond: http://commons.wikimedia.org/wiki/File:Algae_Covered_Pond_Cherry_Hill_Road_Superior_Township_Michigan.JPG; Pitcher plant: <http://www.flickr.com/photos/11014423@N07/2916359254/> . Blue lake: Public Domain; Algae pond: CC BY 3.0; Pitcher plant: CC BY 2.0
27. Top: Flickr:LearningLark; Bottom: Laura Guerin (CK-12 Foundation). Top: <http://www.flickr.com/photos/44282411@N04/7610164322/> . Top: CC BY 2.0; Bottom: CC BY-NC 3.0

CHAPTER

10

Chemistry of Solutions

Chapter Outline

- 10.1 INTRODUCTION TO SOLUTIONS
- 10.2 SOLUBILITY AND CONCENTRATION
- 10.3 ACIDS AND BASES
- 10.4 REFERENCES



It can be really exciting to explore a big underground cave like the one in this picture. Do you know how caves form? Believe it or not, water is the answer. Water slowly dissolves rocks, especially certain types of rocks such as limestone. How does something as mild and harmless as water cause hard rocks to dissolve? In this chapter, you'll find out.

Image copyright Dudarev Mikhail, 2013. www.shutterstock.com. Used under license from Shutterstock.com.

10.1 Introduction to Solutions

Lesson Objectives

- Explain how solutions form.
- Identify properties of solutions.

Lesson Vocabulary

- insoluble
- soluble
- solute
- solvent

Introduction

When rocks or other substances dissolve in water, they form a solution. A solution is a homogeneous mixture of two or more substances. The particles of a solution are mixed evenly throughout it. The particles are too small to be seen or to settle out. An example of a solution is salt water.

Solutes and Solvents

A solution forms when one substance dissolves in another. The substance that dissolves is called the **solute**. The substance it dissolves in is called the **solvent**. For example, ocean water is a solution in which the solute is salt and the solvent is water. In this example, a solid (salt) is dissolved in a liquid (water). However, matter in any state can be the solute or solvent in a solution. Solutions may be gases, liquids, or solids. In **Table 10.1** and the video at the URL below, you can learn about solutions involving other states of matter.

<http://www.youtube.com/watch?v=NsdBUWnG2cQ>

TABLE 10.1: Solutions and States of Matter

Solution	Solute	Solvent
Gas dissolved in gas <i>Example:</i> Earth's atmosphere	oxygen (and other gases)	nitrogen
Gas dissolved in liquid <i>Example:</i> carbonated water	carbon dioxide	water
Liquid dissolved in gas <i>Example:</i> moist air	water	air

TABLE 10.1: (continued)

Solution	Solute	Solvent
Liquid dissolved in liquid <i>Example: vinegar</i>	acetic acid	water
Solid dissolved in liquid <i>Example: sweet tea</i>	sugar	tea
Solid dissolved in solid <i>Example: bronze</i>	copper	tin

When a solute dissolves in a solvent, it changes to the same state as the solvent. For example, when solid salt dissolves in liquid water, it becomes part of the liquid solution, salt water. If the solute and solvent are already in the same state, the substance present in greater quantity is considered to be the solvent. For example, nitrogen is the solvent in Earth's atmosphere because it makes up 78 percent of air.

How a Solute Dissolves

When a solute dissolves, it separates into individual particles that spread evenly throughout the solvent. Exactly how this happens depends on the type of bonds the solute contains. Solutes with ionic bonds, such as table salt (NaCl), separate into individual ions (Na^+ and Cl^-). Solutes with covalent bonds, such as glucose ($\text{H}_6\text{C}_{12}\text{O}_6$), separate into individual molecules. In either case, the individual ions or molecules spread apart and are surrounded by molecules of the solvent. This is illustrated in **Figure 10.1** and in the videos at the URLs below.

<http://www.youtube.com/watch?v=gN9euz9jzwc> (0:47)

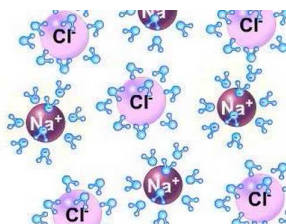

MEDIA

Click image to the left for more content.

<http://www.youtube.com/watch?v=hydUVGUbyvU> (1:38)

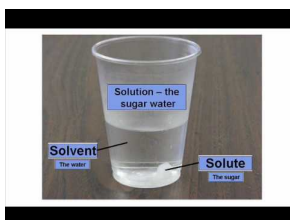

MEDIA

Click image to the left for more content.

Rate of Dissolving

When you add sugar to a cold drink, you may stir it to help the sugar dissolve. If you don't stir, the sugar may eventually dissolve, but it will take much longer. Stirring is one of several factors that affect how fast a solute dissolves in a solvent. Temperature is another factor. A solid solute dissolves faster at a higher temperature. For example, sugar dissolves faster in hot tea than in ice tea. A third factor that affects the rate of dissolving is the surface area of the solute. For example, if you put granulated sugar in a glass of ice tea, it will dissolve more quickly than

How Salt Dissolves in Water

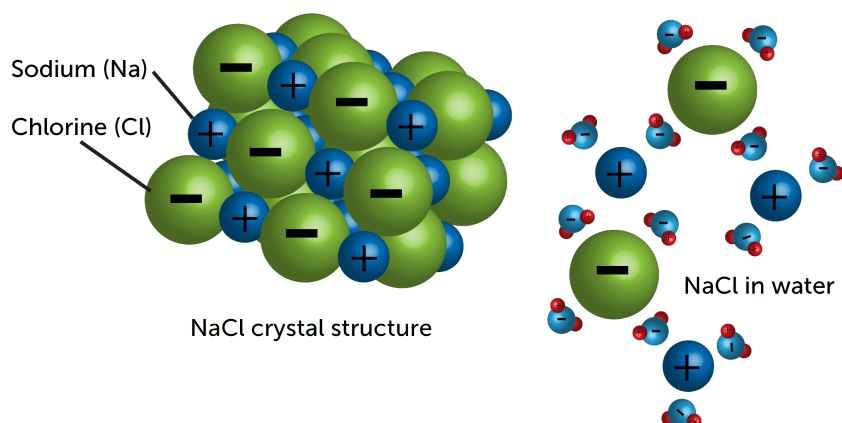

The negative oxygen ends of water molecules attract the positive sodium ions. The positive hydrogen ends of water molecules attract the negative chloride ions. These forces of attraction pull the ions apart.

How Sugar Dissolves in Water

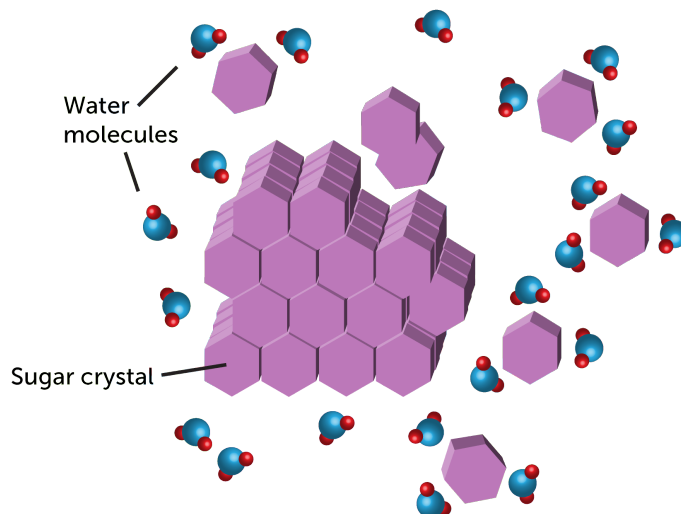

Forces of attraction between positive and negative ends of water and sugar molecules pull individual sugar molecules away from the sugar crystal. Little by little, the sugar molecules are separated from the crystal and surrounded by water.

FIGURE 10.1

These two diagrams show how an ionic compound (salt) and a covalent compound (sugar) dissolve in a solvent (water).

the same amount of sugar in a cube. That's because granulated sugar has much more surface area than a cube of sugar. You can see videos of all three factors at these URLs:

<http://www.youtube.com/watch?v=cF55VAk1NIk> (1:04)



MEDIA

Click image to the left for more content.

<http://www.youtube.com/watch?v=Yb-TdSqmIvc> (1:04)

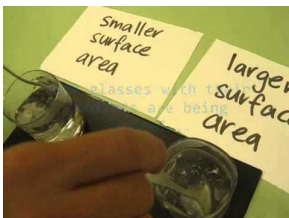

MEDIA

Click image to the left for more content.

<http://www.youtube.com/watch?v=TO42FOay7rg> (1:38)

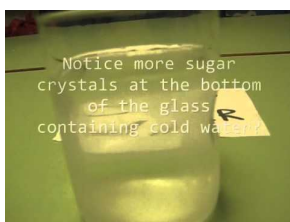

MEDIA

Click image to the left for more content.

The Almost-Universal Solvent

Water is a polar compound. This means it has positively and negatively charged ends. This is why it is so good at dissolving ionic compounds such as salt and polar covalent compounds such as sugar. Solutes that can dissolve in a given solvent, such as water, are said to be **soluble** in that solvent. So many solutes are soluble in water that water is called the universal solvent.

However, there are substances that don't dissolve in water. Did you ever try to clean a paintbrush after painting with an oil-based paint? It doesn't work. Oil-based paint is nonpolar, so it doesn't dissolve in water. In other words, it is **insoluble** in water. Instead, a nonpolar solvent such as paint thinner must be used to dissolve nonpolar paint. You can see a video about soluble and insoluble solutes at this URL: <http://www.youtube.com/watch?v=ek6CVVJk4OQ> (1:51).

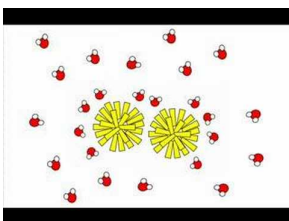

MEDIA

Click image to the left for more content.

Properties of Solutions

When a solute dissolves in a solvent, it changes the physical properties of the solvent. Two properties that change when a solute is added are the freezing and boiling points. Generally, solutes lower the freezing point and raise the boiling point of solvents. You can see some examples of this in **Figure** below. To see why solutes change the freezing and boiling points of solvents, watch this video: <http://www.youtube.com/watch?v=z9LxdqYntIU> (14:00).

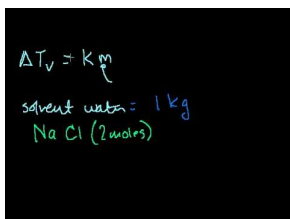

MEDIA

Click image to the left for more content.

In each of these examples, a solute changes the freezing and/or boiling points of a solvent.

Lesson Summary

- A solution forms when a solute dissolves in a solvent. The rate of dissolving is faster with stirring, a higher temperature, or greater surface area. Many solutes are soluble in water because water is polar.
- Solutes change the physical properties of solvents. They lower the freezing point and raise the boiling point of solvents.

Lesson Review Questions

Recall

1. What is a solute? What is a solvent?
2. Describe how an ionic compound such as salt dissolves in water.
3. List three factors that affect the rate at which a solute dissolves.
4. How do solutes affect the properties of solvents?

Apply Concepts

5. Create a lesson that explains to younger students how solutions form. With your teacher's approval, request permission to present your lesson to students in a lower grade.

Think Critically

6. Do you think paint thinner is soluble in water? Why or why not?

Points to Consider

Assume that you will stir salt into a cup of hot water to make a saltwater solution.

- How much salt do you think you could dissolve in the cup of hot water?
- Do you think you could dissolve more of some solutes than others?

10.2 Solubility and Concentration

Lesson Objectives

- Define solubility, and list factors that affect it.
- Define concentration, and explain how to calculate it.

Lesson Vocabulary

- saturated solution
- solubility
- unsaturated solution

Introduction

Tanya and Jon want to see if baking soda or sugar dissolves faster in water. Tanya adds 500 g of baking soda to 500 mL of room-temperature water. At the same time, Jon adds 500 g of table sugar to 500 mL of room-temperature water. Both students start stirring the mixture they made. In less than a minute, all of the sugar in Jon's mixture has dissolved. Tanya keeps stirring her mixture of baking soda and water, but after 5 minutes, some of the baking soda still hasn't dissolved. Even if Tanya kept stirring her mixture all day, the remaining baking soda would not dissolve. What explains this result? Read on to find out.

Solubility

Solubility is the amount of solute that can dissolve in a given amount of solvent at a given temperature. Some solutes have greater solubility than others in a given solvent. For example, table sugar is much more soluble in water than is baking soda. You can dissolve much more sugar than baking soda in a given amount of water. Compare the solubility of these and other solutes in **Figure 10.2**. For a video about solubility, go to this URL: <http://www.youtube.com/watch?v=IKimraU21ws> (10:21).

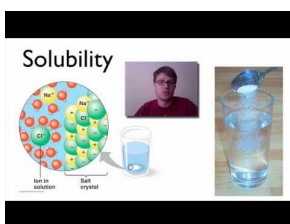

MEDIA

Click image to the left for more content.

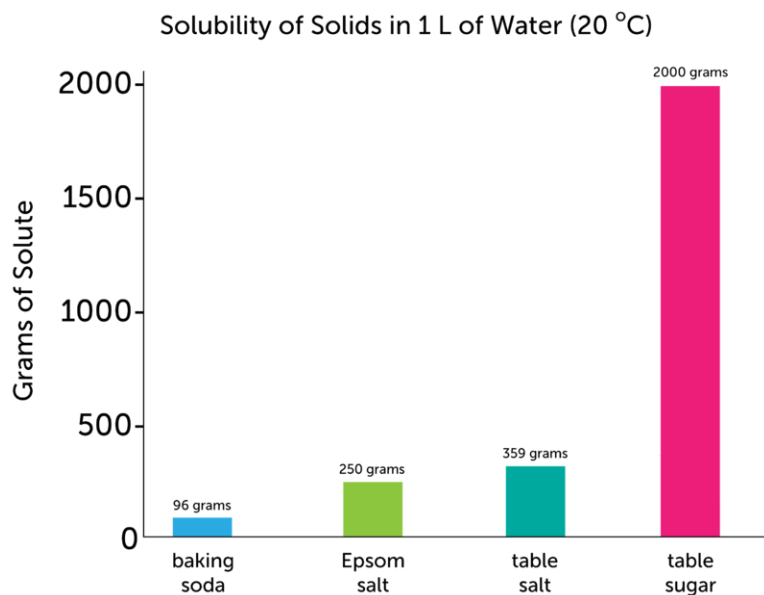
**FIGURE 10.2**

This graph shows the amount of different solids that can dissolve in 1 L of water at 20 degrees C.

Saturation

There is a limit on the amount of solute that can dissolve in a given solvent. Tanya found this out with her baking soda mixture. But even sugar, which is very soluble, has an upper limit. The maximum amount of table sugar that will dissolve in 1 L of water at 20°C is about 2000 g. If you add more sugar than this, the extra sugar won't dissolve.

A solution that contains as much solute as can dissolve at a given temperature is called a **saturated solution**. A solution that contains less solute than can dissolve at a given temperature is called an **unsaturated solution**. A solution of 2000 grams of sugar in 1 L of 20°C water is saturated. That's all the sugar the solution can hold. Any solution containing less than 2000 g of sugar is unsaturated. It can hold more sugar. To learn more about saturated and unsaturated solutions, watch the video at this URL: <http://www.youtube.com/watch?v=IKimraU21ws> .

You Try It!

Problem: A solution contains 249 grams of Epsom salt in 1 L of water at 20°C. Is the solution saturated or unsaturated?

Problem: Give an example of an unsaturated solution of table salt in 1 L of 20°C water.

Factors that Affect Solubility

Certain factors can change the solubility of a solute. Temperature is one such factor. How temperature affects solubility depends on the state of the solute, as you can see in **Figure 10.3**.

- If a solute is a solid or liquid, increasing the temperature increases its solubility. For example, more sugar can dissolve in hot tea than in iced tea.
- If a solute is a gas, increasing the temperature decreases its solubility. For example, less carbon dioxide can dissolve in warm ocean water than in cold ocean water.

The solubility of gases is also affected by pressure. Pressure is the amount of force pushing against a given area. Increasing the pressure on a gas increases its solubility. Did you ever open a can of soda and notice how it fizzes out of the can? Soda contains carbon dioxide. Opening the can reduces the pressure on the gas so it is less soluble. As a result, some of the carbon dioxide comes out of solution and rushes into the air.

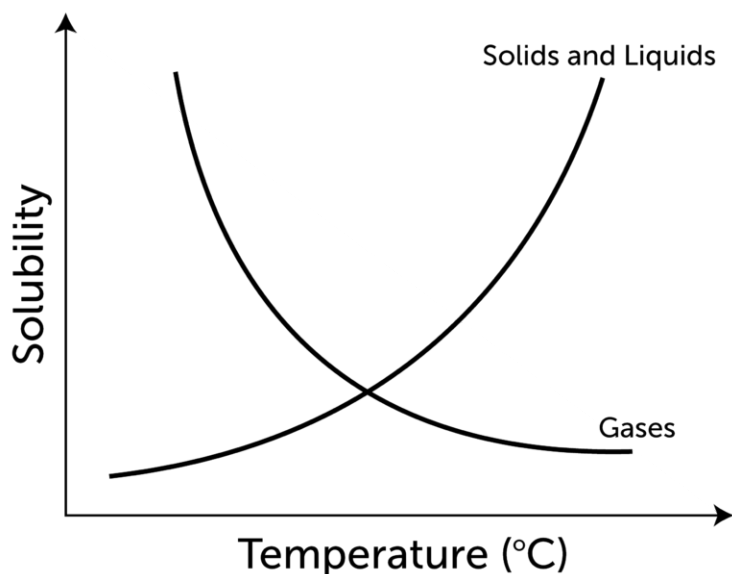
**FIGURE 10.3**

Temperature affects the solubility of a solute. However, it affects the solubility of gases differently than the solubility of solids and liquids.

Do you wonder why temperature and pressure affect solubility in these ways? If so, watch the video at the URL below. It explains why.

<http://www.youtube.com/watch?v=IKimraU21ws>

**FIGURE 10.4**

Soda fizzes when carbon dioxide comes out of solution. Which do you think will fizz more, warm soda or cold soda?

Concentration

The concentration of a solution is the amount of solute in a given amount of solution. A solution with little dissolved solute has a low concentration. It is called a dilute solution. A solution with a lot of dissolved solute has a high concentration. It is called a concentrated solution. Concentration is often expressed as a percent. You can calculate the concentration of a solution using this formula:

$$\text{Concentration} = \frac{\text{Mass (or Volume) of Solute}}{\text{Mass (or Volume) of Solution}} \times 100\%$$

For example, if a 100 g solution of salt water contains 3 g of salt, then its concentration is:

$$\text{Concentration} = \frac{3 \text{ g}}{100 \text{ g}} \times 100\% = 3\%$$

For some problems that are more challenging, go to these URLs:

<http://www.youtube.com/watch?v=RCbkh3yyM88> (4:03)

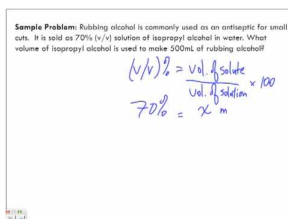

MEDIA

Click image to the left for more content.

<http://www.youtube.com/watch?v=dHxXtkH8ILs> (3:39)

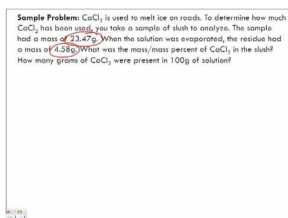

MEDIA

Click image to the left for more content.

You Try It!

Problem: A 1 L container of juice drink, called brand A, contains 250 mL of juice. The rest of the drink is water. How concentrated is brand A juice drink?

Problem: A 600 mL container of another juice drink, called brand B, contains 200 mL of juice. Which brand of juice drink is more concentrated, brand A or brand B?

Lesson Summary

- Solubility is the amount of solute that can dissolve in a given amount of solvent at a given temperature. A solution that contains as much solute as can dissolve at a given temperature is saturated. A solution that contains less solute than can dissolve at a given temperature is unsaturated. Factors such as temperature affect solubility.
- The concentration of a solution is the amount of solute in a given amount of solution. A dilute solution has a low concentration of solute. A concentrated solution has a high concentration of solute.

Lesson Review Questions

Recall

1. Define solubility.

2. Describe how temperature affects the solubility of gases, liquids, and solids.
3. State the effect of pressure on the solubility of gases.
4. What is the concentration of a solution?

Apply Concepts

5. Regina made a solution with 50 mL of lemon juice and 200 mL of water. How much solution did she make? Which is the solute and which is the solvent? What is the concentration of the solution?

Think Critically

6. A glass of warm soda goes flat more quickly than a glass of cold soda. Explain why.
7. Use data in the graph in **Figure 10.2** to describe a saturated solution of baking soda and water.

Points to Consider

Some solutions have special properties because they are acids. Orange juice is an example. It contains an acid called citric acid. It makes orange juice taste sour. Some solutions are bases rather than acids.

- Do you know examples of bases?
- How might bases differ from acids?

10.3 Acids and Bases

Lesson Objectives

- Describe acids and how to detect them.
- Describe bases and how to detect them.
- Explain what determines the strength of acids and bases.
- Outline neutralization reactions and the formation of salts.

Lesson Vocabulary

- acid
- acidity
- base
- neutralization reaction
- pH
- salt

Introduction

No doubt you are familiar with some common acids. Besides orange juice, vinegar and lemon juice are both acids. Look at the boy in **Figure 10.5**. You can tell by the expression on his face that lemon juice tastes sour. In fact, all acids taste sour. They share certain other properties as well. You will learn more about their properties in this lesson. For a musical rendition of lesson content, go to this URL: <http://www.youtube.com/watch?v=zTLiJE-j1-I> .

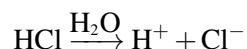

FIGURE 10.5

Like other acids, lemon juice tastes sour.

Acids

An **acid** is an ionic compound that produces positive hydrogen ions (H^+) when dissolved in water. An example is hydrogen chloride (HCl). When it dissolves in water, its hydrogen ions and negative chloride ions (Cl^-) separate, forming hydrochloric acid. This can be represented by the equation:



Properties of Acids

You already know that a sour taste is one property of acids. (**Never** taste an unknown substance to see whether it is an acid!) Acids have certain other properties as well. For example, acids can conduct electricity because they consist of charged particles in solution. Acids also react with metals to produce hydrogen gas. For example, when hydrochloric acid (HCl) reacts with the metal magnesium (Mg), it produces magnesium chloride (MgCl_2) and hydrogen (H_2). This is a single replacement reaction, represented by the chemical equation:

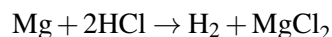

You can see an online demonstration of a similar reaction at this URL: <http://www.youtube.com/watch?v=oQz5YEsx7Fo> .

Detecting Acids

Certain compounds, called indicators, change color when acids come into contact with them. They can be used to detect acids. An example of an indicator is a compound called litmus. It is placed on small strips of paper that may be red or blue. If you place a few drops of acid on a strip of blue litmus paper, the paper will turn red. You can see this in **Figure 10.6**. Litmus isn't the only indicator for detecting acids. Red cabbage juice also works well, as you can see in this entertaining video: <http://www.youtube.com/watch?v=vrOUdoS2BtQ> .



FIGURE 10.6

Blue litmus paper turns red when placed in an acidic solution.

Uses of Acids

Acids have many important uses, especially in industry. For example, sulfuric acid is used to manufacture a variety of different products, including paper, paint, and detergent. Some other uses of acids are illustrated in **Figure 10.7**.



Both nitric acid and phosphoric acid are used to make fertilizer.



Hydrochloric acid is used to clean swimming pools, bricks, and concrete.



Sulfuric acid is an important component of car batteries.

FIGURE 10.7

Acids are used widely for many purposes.

Bases

A **base** is an ionic compound that produces negative hydroxide ions (OH^-) when dissolved in water. For example, when the compound sodium hydroxide (NaOH) dissolves in water, it produces hydroxide ions and positive sodium ions (Na^+). This can be represented by the equation:

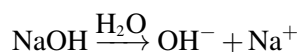

Properties of Bases

All bases share certain properties, including a bitter taste. (**Never** taste an unknown substance to see whether it is a base!) Did you ever taste unsweetened cocoa powder? It tastes bitter because it is a base. Bases also feel slippery. Think about how slippery soap feels. Soap is also a base. Like acids, bases conduct electricity because they consist of charged particles in solution.

Detecting Bases

Bases change the color of certain compounds, and this property can be used to detect them. A common indicator of bases is red litmus paper. Bases turn red litmus paper blue. You can see an example in **Figure 10.8**. Red cabbage juice can detect bases as well as acids, as you'll see by reviewing this video: <http://www.youtube.com/watch?v=rOUdoS2BtQ> (3:14).



MEDIA

Click image to the left for more content.



FIGURE 10.8

Red litmus paper turns blue when placed in a basic solution.

Uses of Bases

Bases are used for a variety of purposes. For example, soaps contain bases such as potassium hydroxide. Other uses of bases are pictured in **Figure 10.9**.



Many cleaning products contain bases such as sodium hydroxide.



Concrete contains the base calcium hydroxide.



Deodorant may contain the base aluminum hydroxide.

FIGURE 10.9

Bases are used in many products.

Strength of Acids and Bases

The acid in vinegar is weak enough to safely eat on a salad. The acid in a car battery is strong enough to eat through skin. The base in antacid tablets is weak enough to take for an upset stomach. The base in drain cleaner is strong enough to cause serious burns. What causes these differences in strength of acids and bases?

Concentration of Ions

The strength of an acid depends on the concentration of hydrogen ions it produces when dissolved in water. A stronger acid produces a greater concentration of ions than a weaker acid. For example, when hydrogen chloride is added to water, all of it breaks down into H^+ and Cl^- ions. Therefore, it is a strong acid. On the other hand, only about 1 percent of acetic acid breaks down into ions, so it is a weak acid.

The strength of a base depends on the concentration of hydroxide ions it produces when dissolved in water. For example, sodium hydroxide completely breaks down into ions in water, so it is a strong base. However, only a fraction of ammonia breaks down into ions, so it is a weak base.

The pH Scale

The strength of acids and bases is measured on a scale called the pH scale (see **Figure 10.10**). The symbol **pH** represents **acidity**, or the concentration of hydrogen ions (H^+) in a solution. Pure water, which is neutral, has a pH of 7. With a higher concentration of hydrogen ions, a solution is more acidic but has a lower pH. Therefore, acids have a pH less than 7, and the strongest acids have a pH close to zero. Bases have a pH greater than 7, and the strongest bases have a pH close to 14. You can watch a video about the pH scale at this URL: <http://www.youtube.com/watch?v=M8tTELZD5Ek> (2:23).

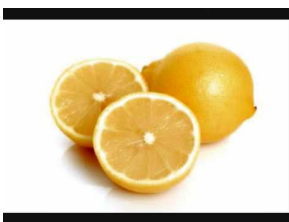

MEDIA

Click image to the left for more content.

Why pH Matters

Acidity is an important factor for living things. For example, many plants grow best in soil that has a pH between 6 and 7. Fish also need a pH close to 7. Some air pollutants form acids when dissolved in water droplets in the air. This results in acid fog and acid rain, which may have a pH of 4 or even lower (see **Figure 10.10**). **Figure 10.11** shows the effects of acid fog and acid rain on a forest. Acid rain also lowers the pH of surface waters such as streams and lakes. As a result, the water became too acidic for fish and many other water organisms to survive.

Even normal (not acid) rain is slightly acidic. That's because carbon dioxide in the air dissolves in raindrops, producing a weak acid called carbonic acid. When acidic rainwater soaks into the ground, it can slowly dissolve rocks, particularly those containing calcium carbonate. This is how water forms caves, like the one that opened this chapter.

Reactions of Acids and Bases

As you read above, an acid produces positive hydrogen ions and a base produces negative hydroxide ions. If an acid and base react together, the hydrogen and hydroxide ions combine to form water. This is represented by the equation:

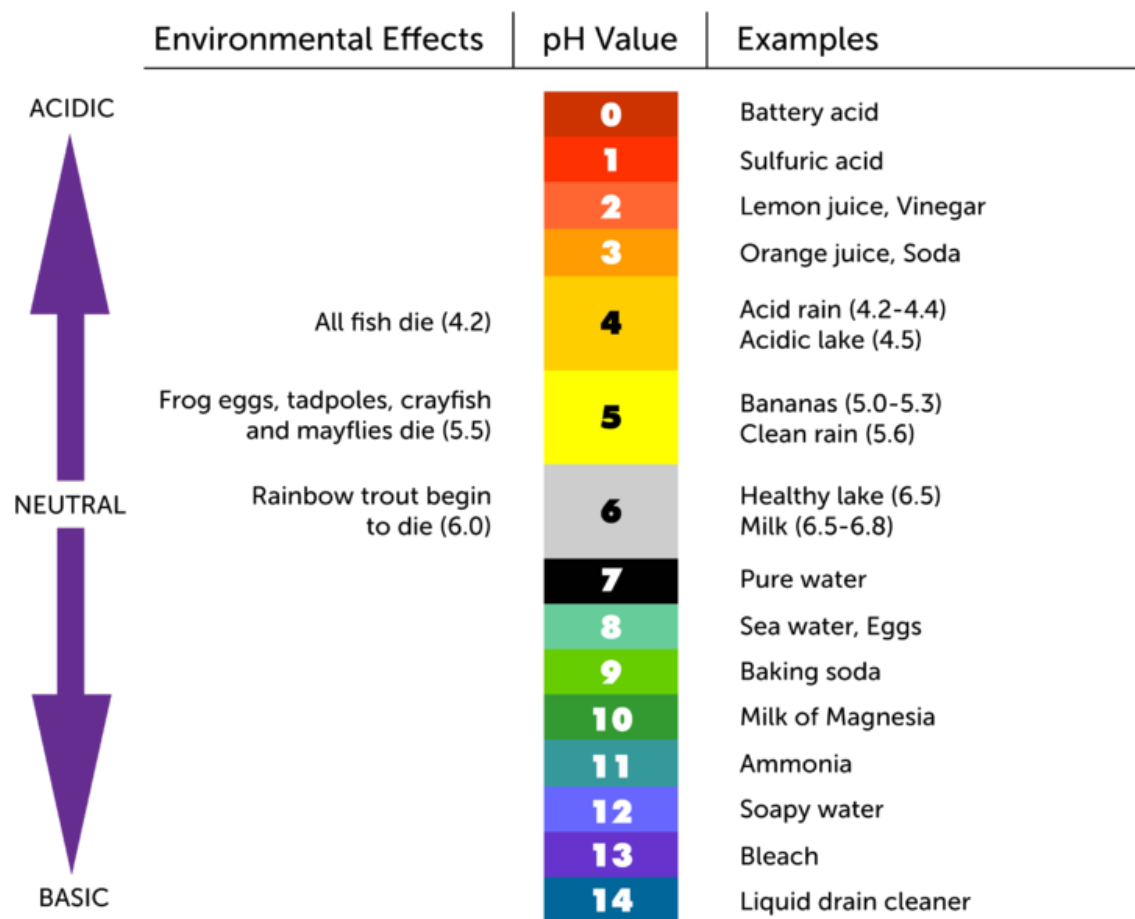

FIGURE 10.10

This pH scale shows the acidity of several common acids and bases. Which substance on this scale is the weakest acid? Which substance is the strongest base?

An acid also produces negative ions, and a base also produces positive ions. For example, the acid hydrogen chloride (HCl), when dissolved in water, produces negative chloride ions (Cl^-) as well as hydrogen ions. The base sodium hydroxide (NaOH) produces positive sodium ions (Na^+) in addition to hydroxide ions. These other ions also combine when the acid and base react. They form sodium chloride (NaCl). This is represented by the equation:



Sodium chloride is called table salt, but salt is a more general term. A **salt** is any ionic compound that forms when an acid and base react. It consists of a positive ion from the base and a negative ion from the acid. Like pure water, a salt is neutral in pH. That's why reactions of acids and bases are called **neutralization reactions**. Another example of a neutralization reaction is described in **Figure 10.12**. You can learn more about salts and how they form at this



FIGURE 10.11

Acid fog and acid rain killed the trees in this forest.

URL: <http://www.youtube.com/watch?v=zjIVJh4JLNo> (13:21).

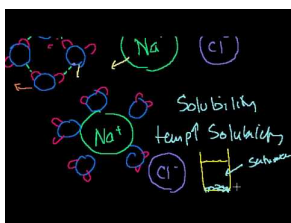

MEDIA

Click image to the left for more content.

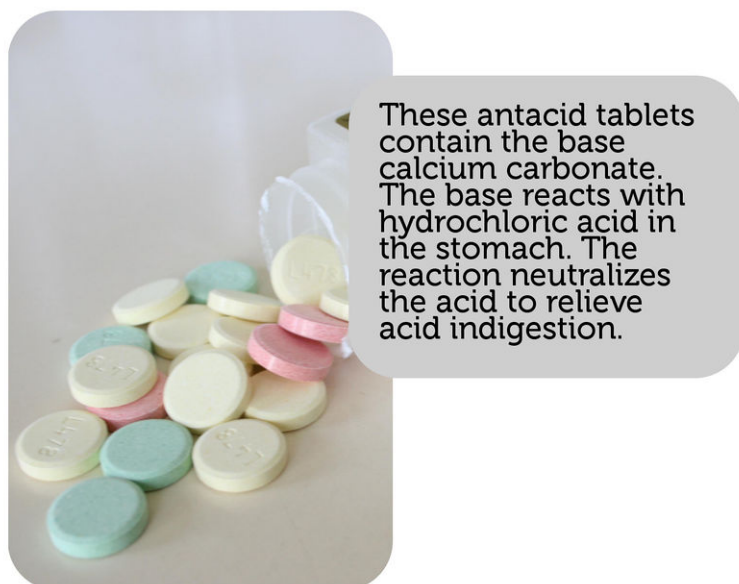

These antacid tablets contain the base calcium carbonate. The base reacts with hydrochloric acid in the stomach. The reaction neutralizes the acid to relieve acid indigestion.

FIGURE 10.12

What neutral products are produced when antacid tablets react with hydrochloric acid in the stomach?

Lesson Summary

- An acid is an ionic compound that produces positive hydrogen ions when dissolved in water. Acids taste sour and turn blue litmus paper red.
- A base is an ionic compound that produces negative hydroxide ions when dissolved in water. Bases taste bitter and turn red litmus paper blue.
- The strength of acids and bases is determined by the concentration of ions they produce when dissolved in water. The concentration of hydrogen ions in a solution is called acidity. It is measured by pH. A neutral substance has a pH of 7. An acid has a pH lower than 7, and a base has a pH greater than 7.
- The reaction of an acid and a base is called a neutralization reaction. It produces a salt and water, both of which are neutral.

Lesson Review Questions

Recall

1. What is an acid? Give one use of acids.
2. What is a base? Name a common product that contains a base.
3. Outline how litmus paper can be used to detect acids and bases.
4. Define acidity. How is it measured?

Apply Concepts

5. An unknown substance has a pH of 7.2. Is it an acid or a base? Explain your answer.
6. If hydrochloric acid (HCl) reacts with the base lithium hydroxide (LiOH), what are the products of the reaction? Write a chemical equation for the reaction.

Think Critically

7. Battery acid is a stronger acid than lemon juice. Explain why.

Points to Consider

Neutralization reactions, like the other chemical reactions you have read about so far, involve electrons. Electrons are outside the nucleus of an atom. Certain other reactions involve the nucleus of an atom instead. These reactions are called nuclear reactions. You will read about them in the next chapter, "Nuclear Chemistry."

- How do you think nuclear reactions might differ from chemical reactions?
- Elements involved in nuclear reactions are radioactive. How do you think radioactive elements differ from other elements?

10.4 References

1. Christopher Auyeung. [CK-12 Foundation](#) . CC BY-NC 3.0
2. Salt truck: Michael Pereckas; Salt to pot: Joy Sheng; Antifreeze: Courtesy of the EPA. [Salt truck](#): http://commons.wikimedia.org/wiki/File:Salt_truck_Milwaukee.jpg; [Salt to pot](#): CK-12 Foundation; [Antifreeze](#): <http://www.epa.gov/wastes/conserva/materials/antifree.htm> . Salt truck: CC BY 2.0; Salt to pot: CC BY-NC 3.0; Antifreeze: public domain
3. Christopher Auyeung. [CK-12 Foundation](#) . CC BY-NC 3.0
4. Christopher Auyeung. [CK-12 Foundation](#) . CC BY-NC 3.0
5. Amy (Flickr: Amy Loves Yah). <http://www.flickr.com/photos/amylovesyah/4407488395/> . CC BY 2.0
6. Image copyright Gelpi JM, 2013. <http://www.shutterstock.com> . Used under license from Shutterstock.com
7. Christopher Ayueng. [CK-12 Foundation](#) . CC BY-NC 3.0
8. Fertilizer and Pool Cleaner: Christopher Auyeung; Battery: User:Shaddack/Wikimedia Commons. [Fertilizer and Pool Cleaner](#): CK-12 Foundation; [Battery](#): <http://commons.wikimedia.org/wiki/File:Photo-CarBattery.jpg> . Fertilizer and Pool Cleaner: CC BY-NC 3.0; Battery: Public Domain
9. Christopher Auyeung. [CK-12 Foundation](#) . CC BY-NC 3.0
10. Soap: Ross Elliot; Concrete: Matsuoka Akiyoshi; Deodorant: User:Ggonnell/Wikimedia Commons. [Soap](#): http://commons.wikimedia.org/wiki/File:Apricot_and_menthe_soap.jpg; [Concrete](#): <http://commons.wikimedia.org/wiki/File:U%E5%AD%97%E6%BA%9DP5221687.JPG>; [Deodorant](#): http://commons.wikimedia.org/wiki/File:Deoroller_DB_%28blur%29.jpg . Soap: CC BY 2.0; Concrete: Public Domain; Deodorant: Public Domain
11. Christopher Auyeung. [CK-12 Foundation](#) . CC BY-NC 3.0
12. User:Nipik/Wikimedia Commons. http://commons.wikimedia.org/wiki/File:Acid_rain_woods1.JPG . Public Domain
13. User:Midnightcomm/Wikimedia Commons. <http://commons.wikimedia.org/wiki/File:Antacid-L478.jpg> . CC BY 2.5

CHAPTER **11**

Nuclear Chemistry

Chapter Outline

- 11.1 RADIOACTIVITY
- 11.2 RADIOACTIVE DECAY
- 11.3 NUCLEAR ENERGY
- 11.4 REFERENCES



If you lived during the Middle Ages (between 400 and 1400 A.D.), you might see a scene like the one pictured here. The man in the picture is an alchemist. Alchemists were people who strived to turn lead into gold. They tried all sorts of chemical reactions involving lead, but they were never able to produce gold. As you learned in an earlier chapter, an element cannot be changed into another element by any type of chemical reaction. However, scientists now know there is a way that some elements can change into others. You'll find out what it is when you read this chapter.

Adriaen van Ostade. commons.wikimedia.org/wiki/File:Adriaen_van_Ostade_-_Alchemist_-_WGA16738.jpg. Public Domain.

11.1 Radioactivity

Lesson Objectives

- Explain radioactivity and how it was discovered.
- Describe source, dangers, and uses of radiation.

Lesson Vocabulary

- radiation
- radioactivity
- radioisotope

Introduction

Some elements naturally change into different elements. To understand how this happens, first recall what an element is. An element is a unique substance, with a unique number of protons in the nucleus of its atoms. No two elements have the same number of protons. For example, carbon atoms always have six protons. If an atom has a different number of protons, it isn't carbon. For an element to change into a different element, then, it must change the number of protons in the nucleus of its atoms. This happens only in radioactive elements.

Introduction to Radioactivity

Radioactivity is the ability of an atom to emit, or give off, charged particles and energy from the nucleus. The charged particles and energy are called by the general term **radiation**. Only unstable nuclei emit radiation. When they do, they gain or lose protons. Then the atoms become different elements. (Be careful not to confuse this radiation with electromagnetic radiation, which has to do with the light given off by atoms as they absorb and then emit energy.)

Discovery of Radioactivity

Radioactivity was discovered in 1896 by a French physicist named Antoine Henri Becquerel. Becquerel was experimenting with uranium, which glows after being exposed to sunlight. Becquerel wanted to see if the glow was caused by rays of energy, like rays of light and X-rays. He placed a bit of uranium on a photographic plate. The plate was similar to film that's used today to take X-rays. You can see an example of an X-ray in **Figure 11.1**. As Becquerel predicted, the uranium left an image on the photographic plate. This meant that uranium gives off rays after being exposed to sunlight.

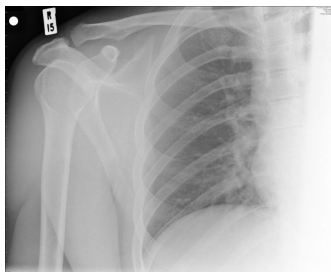
**FIGURE 11.1**

X-rays are a form of energy that can pass through skin and muscle but not bone. That's why bones show up clearly in an X-ray, while the rest of the body is barely visible.

Becquerel was a good scientist, so he wanted to repeat his experiment to confirm his results. He placed more uranium on another photographic plate. However, the day had turned cloudy, so he tucked the plate and uranium in a drawer to try again another day. He wasn't expecting the uranium to leave an image on the plate without being exposed to sunlight. To his surprise, there was an image on the plate in the drawer the next day. Becquerel had discovered that uranium gives off rays without getting energy from light. He had discovered radioactivity, for which he received a Nobel prize. To learn more about the importance of Becquerel's research, go to this URL: http://nobelprize.org/nobel_prizes/physics/laureates/1903/becquerel-bio.html .

Another scientist, who worked with Becquerel, actually came up with the term "radioactivity." The other scientist was the French chemist Marie Curie. She went on to discover the radioactive elements polonium and radium. She won two Nobel Prizes for her discoveries. You can learn more about Marie Curie at this URL: http://nobelprize.org/nobel_prizes/physics/laureates/1903/marie-curie-bio.html .

Radioisotopes

Isotopes are atoms of the same element that differ from each other because they have different numbers of neutrons. Many elements have one or more isotopes that are radioactive. Radioactive isotopes are called **radioisotopes**.

An example of a radioisotope is carbon-14. All carbon atoms have 6 protons, and most have 6 neutrons. These carbon atoms are called carbon-12, where 12 is the mass number (6 protons + 6 neutrons). A tiny percentage of carbon atoms have 8 neutrons instead of the usual 6. These atoms are called carbon-14 (6 protons + 8 neutrons). The nuclei of carbon-14 are unstable because they have too many neutrons. To be stable, a small nucleus like carbon, with just 6 protons, must have a 1:1 ratio of protons to neutrons. In other words, it must have the same number of neutrons as protons. In a large nucleus, with many protons, the ratio must be 2:1 or even 3:1 protons to neutrons.

In elements with more than 83 protons, all the isotopes are radioactive (see **Figure 11.2**). The force of repulsion among all those protons overcomes the strong force holding them together. This makes the nuclei unstable and radioactive. Elements with more than 92 protons have such unstable nuclei that these elements do not even exist in nature. They exist only if they are created in a lab.

Radiation in the World Around Us

A low level of radiation occurs naturally in the environment. This is called background radiation. It comes from various sources. One source is rocks, which may contain small amounts of radioactive elements such as uranium. Another source is cosmic rays. These are charged particles that arrive on Earth from outer space. Background radiation is generally considered to be safe for living things.

A source of radiation that may be more dangerous is radon. Radon is a radioactive gas that forms in rocks underground. It can seep into basements and get trapped inside buildings. Then it may build up and become harmful

PERIODIC TABLE OF ELEMENTS

■ indicates a radioactive element

1 1A H 1.00794 HYDROGEN	PERIODIC TABLE OF ELEMENTS																18 8A He 4.0026 HELIUM
3 Li 6.941 LITHIUM	4 2A Be 9.0122 BERYLLIUM											5 B 10.811 BORON	6 C 12.0107 CARBON	7 N 14.0064 NITROGEN	8 O 15.999 OXYGEN	9 F 18.998 FLUORINE	10 Ne 20.1797 NEON
11 Na 22.990 SODIUM	12 Mg 24.305 MAGNESIUM	3	4	5	6	7	8	9	10	11	12	13 Al 26.982 ALUMINUM	14 Si 28.086 SILICON	15 P 30.974 PHOSPHORUS	16 S 32.06 SULFUR	17 Cl 35.45 CHLORINE	18 Ar 39.948 ARGON
19 K 39.098 POTASSIUM	20 Ca 40.078 CALCIUM	21 Sc 44.956 SCANDIUM	22 Ti 47.88 TITANIUM	23 V 50.942 VANADIUM	24 Cr 51.996 CHROMIUM	25 Mn 54.938 MANGANESE	26 Fe 55.845 IRON	27 Co 58.933 COBALT	28 Ni 58.693 NICKEL	29 Cu 63.546 COPPER	30 Zn 65.38 ZINC	31 Ga 69.723 GALLIUM	32 Ge 72.63 GERMANIUM	33 As 74.922 ARSENIC	34 Se 78.96 SELENIUM	35 Br 79.904 BROMINE	36 Kr 83.80 KRYPTON
37 Rb 85.468 RUBIDIUM	38 Sr 87.62 STRONTIUM	39 Y 88.906 YTIUM	40 Zr 91.224 ZIRCONIUM	41 Nb 92.906 NIOBIUM	42 Mo 95.94 MOLYBDENUM	43 Tc 98.906 TECHNETIUM	44 Ru 101.07 RHODIUM	45 Rh 102.905 RHODIUM	46 Pd 106.42 PALLADIUM	47 Ag 107.868 SILVER	48 Cd 112.411 CADMIUM	49 In 114.818 INDIUM	50 Sn 118.710 TIN	51 Sb 121.757 ANTIMONY	52 Te 127.60 TELLURIUM	53 I 126.905 IODINE	54 Xe 131.29 XENON
55 Cs 132.905 CAESIUM	56 Ba 137.327 BARIUM	57-71 La-Lu LANTHANIDES	72 Hf 178.49 HAFNIUM	73 Ta 180.95 TANTALUM	74 W 183.84 TUNGSTEN	75 Re 186.207 RHENIUM	76 Os 190.23 OSMIUM	77 Ir 192.222 IRIDIUM	78 Pt 195.084 PLATINUM	79 Au 196.967 GOLD	80 Hg 200.59 MERCURY	81 Tl 204.387 THALLIUM	82 Pb 207.2 LEAD	83 Bi 208.98 BISMUTH	84 Po 209 POLONIUM	85 At 210 ASTATINE	86 Rn 222 RADON
87 Fr 223 FRANCIUM	88 Ra 226 RADIUM	89-103 Ac-Lr ACTINIDES	104 Rf 261 RUTHERFORDIUM	105 Db 262 DUBNIUM	106 Sg 263 SEABORGIUM	107 Bh 264 BOHRIUM	108 Hs 265 HASSIUM	109 Mt 266 MEITNERIUM	110 Ds 271 DARMSTADTIUM	111 Rg 272 ROSGENIUM	112 Cn 277 COPIERNICIUM	113 Uut 278 UNUNTRIUM	114 Uuq 279 UNUNQUADIUM	115 Uup 280 UNUNPENTIUM	116 Uuh 281 UNUNHEXIUM	117 Uus 282 UNUNSEPTIUM	118 Uuo 284 UNUNOCTIUM
LANTHANIDES		57 La 138.905 LANTHANUM	58 Ce 140.12 CERIUM	59 Pr 140.908 PRASEODYMIUM	60 Nd 144.242 NEODYMIUM	61 Pm 144.913 PROMETHIUM	62 Sm 150.362 SAMARIUM	63 Eu 151.964 EUROPIUM	64 Gd 157.253 GADOLINIUM	65 Tb 158.925 TERBIUM	66 Dy 162.505 DYSPROSIUM	67 Ho 164.930 HOLMIUM	68 Er 167.259 ERBIUM	69 Tm 168.934 THULIUM	70 Yb 173.04 YTTERIUM	71 Lu 174.967 LUTETIUM	
ACTINIDES		89 Ac 227.027 ACTINIUM	90 Th 232.038 THORIUM	91 Pa 231.036 PROTACTINIUM	92 U 238.029 URANIUM	93 Np 237.048 NEPTUNIUM	94 Pu 244.064 PLUTONIUM	95 Am 243.061 AMERICIUM	96 Cm 247.070 CURIUM	97 Bk 247.070 BERKELIUM	98 Cf 251.080 CALIFORNIUM	99 Es 252.083 EINSTEINIUM	100 Fm 257.085 FERMIUM	101 Md 258.106 MENDELEVIUM	102 No 259.108 NOBELIUM	103 Lr 262.105 LAWRENCIUM	

FIGURE 11.2

This periodic table highlights elements that have only radioactive isotopes.

to people who breathe it. Other sources of radiation are described in the interactive animation at this URL: <http://www.pbs.org/wgbh/nova/dirtybomb/sources.html> .

Dangers of Radiation

You may have seen a sign like the one in **Figure 11.3**. It warns people that there is radiation in the area. Exposure to radiation can be very dangerous. Radiation damages living things by knocking electrons out of atoms and changing them to ions. Radiation also breaks bonds in DNA and other biochemical compounds.

A single large exposure to radiation can burn the skin and cause radiation sickness. Symptoms of this illness include extreme fatigue, destruction of blood cells, and loss of hair. Long-term exposure to lower levels of radiation can cause cancer. For example, radon in buildings can cause lung cancer. Marie Curie died of cancer, most likely because of exposure to radiation in her research. To learn more about the harmful health effects of radiation, go to this URL: <http://www.cbsnews.com/video/watch/?id=7359819n> .

Nonliving things can also be damaged by radiation. For example, high levels of radiation can remove electrons from metals. This may weaken metals in nuclear power plants and space vehicles, both of which are exposed to very high levels of radiation.

**FIGURE 11.3**

This sign is used to warn people of dangerous radiation.

Detecting Radiation

One reason radiation is dangerous is that it can't be detected with the senses. You normally can't see it, smell it, hear it, or feel it. Fortunately, there are devices such as Geiger counters that can detect radiation. A Geiger counter, like the one in **Figure 11.4**, has a tube that contains atoms of a gas. If radiation enters the tube, it turns gas atoms to ions that carry electric current. The current causes the Geiger counter to click. The faster the clicks occur, the higher the level of radiation. You can see a video about the Geiger counter and how it was invented at the URL below.

<http://vimeo.com/10379389>

**FIGURE 11.4**

A Geiger counter detects radiation.

Using Radiation

Despite its dangers, radioactivity has several uses. It can be used to determine the ages of ancient rocks and fossils. This use of radioactivity is explained in this chapter's "Radioactive Decay" lesson. Radioactivity can also be used as a source of power to generate electricity. This use of radioactivity is covered later on in this chapter in the lesson "Nuclear Energy." Radioactivity can even be used to diagnose and treat diseases, including cancer. Cancer cells grow rapidly and take up a lot of glucose for energy. Glucose containing radioactive elements can be given to patients. Cancer cells will take up more of the glucose than normal cells do and give off radiation. The radiation can be detected with special machines (see **Figure 11.5**). Radioactive elements taken up by cancer cells may also be used to kill the cells and treat the disease. You can learn more about medical uses of radiation at the URL below.

http://www.youtube.com/watch?v=v_8xM-mLxJ8 (10:11)



MEDIA

Click image to the left for more content.



FIGURE 11.5

This machine scans a patient's body and detects radiation.

Lesson Summary

- Radioactivity is the ability of an atom to emit radiation in the form of charged particles and energy from the nucleus. Many elements have one or more radioactive isotopes. Elements with more than 83 protons have only radioactive isotopes.
- Harmless background radiation comes from radioactive elements in rocks and from cosmic rays. Other sources of radiation, such as radon, are harmful. They may cause illness in living things and damage materials such as metals. Radiation has several uses, including detecting and treating cancer.

Lesson Review Questions

Recall

1. Define radioactivity.
2. What is radiation?
3. Describe how radioactivity was discovered.
4. What is background radiation? Where does it come from?
5. Why is radiation harmful to both living and nonliving things?
6. Identify three uses of radiation.

Apply Concepts

7. Assume that an isotope has 83 protons and 83 neutrons. Is it radioactive? Why or why not?

Think Critically

8. Explain why elements with more than 83 protons have only radioactive isotopes.

Points to Consider

In this lesson, you read that unstable nuclei emit particles and energy.

- What type of particles do you think unstable nuclei emit?
- What form of energy do you think these nuclei give off?

11.2 Radioactive Decay

Lesson Objectives

- Identify three types of radioactive decay.
- Define the half-life of a radioisotope.
- Explain radioactive dating.

Lesson Vocabulary

- half-life
- radioactive dating
- radioactive decay

Introduction

Unstable nuclei of radioisotopes become stable by emitting charged particles and energy. This process is called **radioactive decay**. It is a nuclear, as opposed to chemical, reaction, in which one element changes into another.

Types of Radioactive Decay

There are three types of radioactive decay: alpha, beta, and gamma decay. In all three types, nuclei emit radiation, but the nature of that radiation differs from one type of decay to another. You can watch a video about the three types at this URL: <http://www.youtube.com/watch?v=3koOwozY4oc> (17:02).

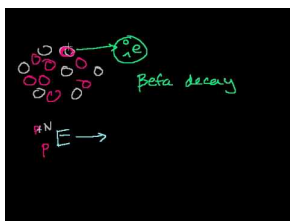

MEDIA

Click image to the left for more content.

Alpha Decay

Alpha decay occurs when an unstable nucleus emits an alpha particle and energy. The diagram in **Figure 11.6** represents alpha decay. An alpha particle contains two protons and two neutrons, giving it a charge of +2. A helium nucleus has two protons and two neutrons, so an alpha particle is represented in nuclear equations by the symbol

${}^4_2\text{He}$. The superscript 4 is the mass number (2 protons + 2 neutrons). The subscript 2 is the charge of the particle as well as the number of protons.

Alpha Decay

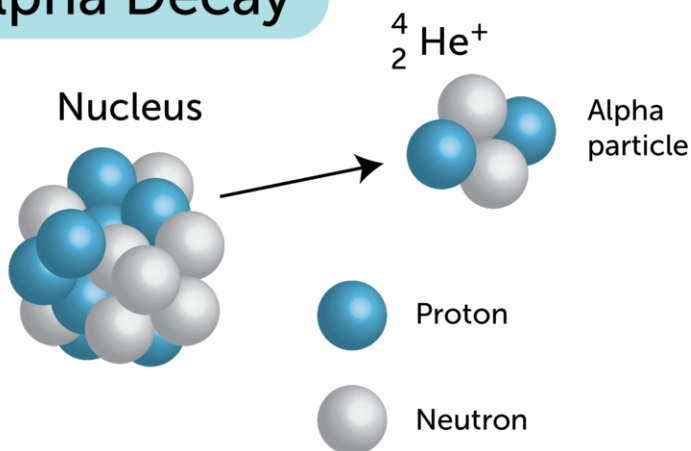
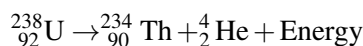

FIGURE 11.6

Alpha decay results in the loss of two protons and two neutrons from a nucleus.

An example of alpha decay is the decay of uranium-238 to thorium-234. In this reaction, uranium loses two protons and two neutrons to become the element thorium. The reaction can be represented by this equation:



If you count the number of protons and neutrons on each side of this equation, you'll see that the numbers are the same on both sides of the arrow. This means that the equation is balanced. The thorium-234 produced in this reaction is unstable, so it will undergo radioactive decay as well. The alpha particle (${}^4_2\text{He}$) produced in the reaction can pick up two electrons to form the element helium. This is how most of Earth's helium formed.

Problem Solving

Problem: Fill in the missing subscript and superscript to balance this nuclear equation: ${}^{208}_{84}\text{Po} \rightarrow ?\text{Pb} + {}^4_2\text{He} + \text{Energy}$

Solution: The subscript is 82, and the superscript is 204.

You Try It!

Problem: Fill in the missing subscript and superscript to balance this nuclear equation: ${}^{222}_{88}\text{Ra} \rightarrow ?\text{Rn} + {}^4_2\text{He} + \text{Energy}$

Beta Decay

Beta decay occurs when an unstable nucleus emits a beta particle and energy. A beta particle is an electron. It has a charge of -1. In nuclear equations, a beta particle is represented by the symbol ${}^0_{-1}e$. The subscript -1 represents the particle's charge, and the superscript 0 shows that the particle has virtually no mass. Nuclei contain only protons and neutrons, so how can a nucleus emit an electron? A neutron first breaks down into a proton and an electron (see **Figure 11.7**). Then the electron is emitted from the nucleus, while the proton stays inside the nucleus. The proton increases the atomic number by one, thus changing one element into another.

An example of beta decay is the decay of thorium-234 to protactinium-234. In this reaction, thorium loses a neutron and gains a proton to become protactinium. The reaction can be represented by this equation:

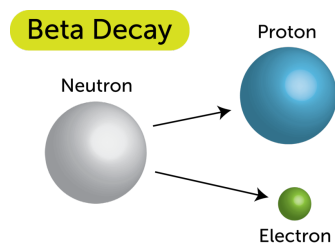
**FIGURE 11.7**

In beta decay, an electron and a proton form from a neutron (another unusual particle, called an antineutrino, is also produced). Only the electron is emitted from the nucleus. How does this change the atomic number and atomic mass of the atom?

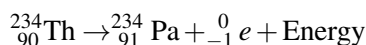

The protactinium-234 produced in this reaction is radioactive and decays to another element. The electron produced in the reaction (plus another electron) can combine with an alpha particle to form helium.

Problem Solving

Problem: Fill in the missing subscript and superscript in this nuclear equation: ${}_{53}^{131}\text{I} \rightarrow ? \text{Xe} + {}_{-1}^0e + \text{Energy}$

Solution: The subscript is 54, and the superscript is 131.

You Try It!

Problem: Fill in the missing subscript and superscript in this nuclear equation: ${}_{7}^{14}\text{C} \rightarrow ? \text{N} + {}_{-1}^0e + \text{Energy}$

Gamma Decay

In alpha and beta decay, both particles and energy are emitted. In gamma decay, only energy is emitted. Gamma decay occurs when an unstable nucleus gives off gamma rays. Gamma rays, like rays of visible light and X-rays, are waves of energy that travel through space at the speed of light. Gamma rays have the greatest amount of energy of all such waves. By itself, gamma decay doesn't cause one element to change into another, but it is released in nuclear reactions that do. Some of the energy released in alpha and beta decay is in the form of gamma rays. You can learn more about gamma radiation at this URL: <http://www.youtube.com/watch?v=okyyBaSOtA> (2:45).



MEDIA

Click image to the left for more content.

Comparing Types of Radiation

The different types of radiation vary in how far they are able to travel and what they can penetrate (see **Figure 11.8** and the URL below).

<http://www.youtube.com/watch?v=ec8iomUS34U> (0:30)

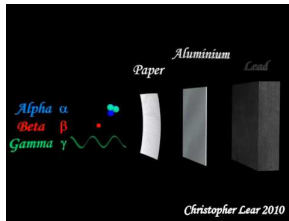

MEDIA

Click image to the left for more content.

- Alpha particles can travel only a few centimeters through air. They cannot pass through a sheet of paper or thin layer of clothing. They may burn the skin but cannot penetrate tissues beneath the skin.
- Beta particles can travel up to a meter through air. They can pass through paper and cloth but not through a sheet of aluminum. They can penetrate and damage tissues beneath the skin.
- Gamma rays can travel thousands of meters through air. They can pass through a sheet of aluminum as well as paper and cloth. They can be stopped only by several centimeters of lead or several meters of concrete. They can penetrate and damage organs deep inside the body.

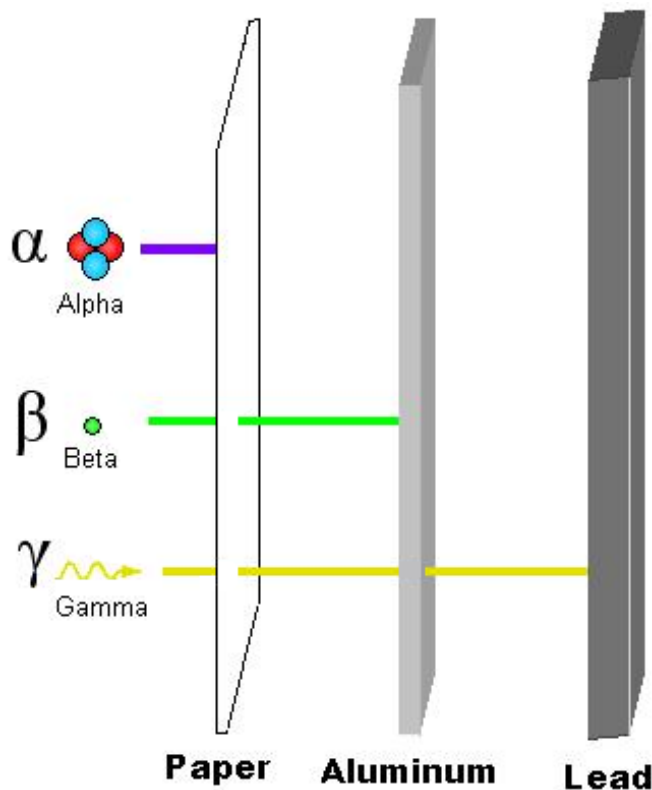

FIGURE 11.8

It's easy to stop alpha particles and even beta particles. However, it's very difficult to stop gamma rays.

Rate of Radioactive Decay

A radioactive isotope decays at a certain constant rate. The rate is measured in a unit called the **half-life**. This is the length of time it takes for half of a given amount of the isotope to decay. The concept of half-life is illustrated in **Figure 11.9** for the beta decay of phosphorus-32 to sulfur-32. The half-life of this radioisotope is 14 days. After

14 days, half of the original amount of phosphorus-32 has decayed. After another 14 days, half of the remaining amount (or one-quarter of the original amount) has decayed, and so on.

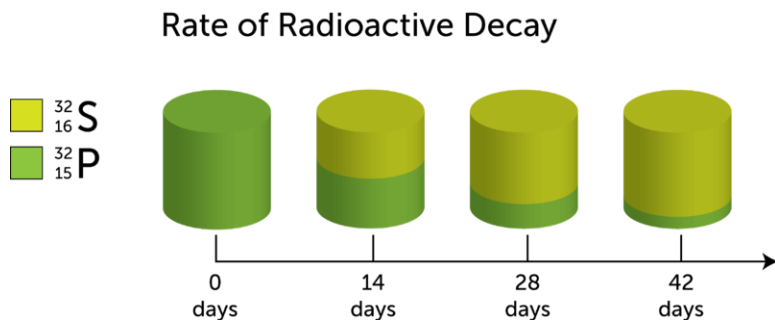
**FIGURE 11.9**

This diagram models the rate of decay of phosphorus-32 to sulfur-32.

Different radioactive isotopes vary greatly in their rate of decay. As you can see from the examples in **Table 11.1**, the half-life of a radioisotope can be as short as a split second or as long as several billion years. You can simulate radioactive decay of radioisotopes with different half-lives at the URL below.

http://www.colorado.edu/physics/2000/isotopes/radioactive_decay3.html

Some radioisotopes decay much more quickly than others.

TABLE 11.1: Half-Life of Some Radioisotopes

Isotope	Half-life
Uranium-238	4.47 billion years
Potassium-40	1.28 billion years
Carbon-14	5,730 years
Hydrogen-3	12.3 years
Radon-222	3.82 days
Polonium-214	0.00016 seconds

Problem Solving

Problem: If you had a gram of carbon-14, how many years would it take for radioactive decay to reduce it to one-quarter of a gram?

Solution: One gram would decay to one-quarter of a gram in 2 half-lives ($\frac{1}{2} \times \frac{1}{2} = \frac{1}{4}$), or $2 \times 5,730$ years = 11,460 years.

You Try It!

Problem: What fraction of a given amount of hydrogen-3 would be left after 36.9 years of decay?

Radioactive Dating

Radioactive isotopes can be used to estimate the ages of fossils and rocks. The method is called **radioactive dating**. Carbon-14 dating is an example of radioactive dating. It is illustrated in the video at this URL: <http://www.youtube.com/watch?v=udkQwW6aLik> (11:00).

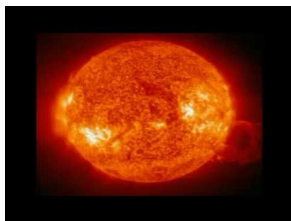

MEDIA

Click image to the left for more content.

How Carbon-14 Dating Works

Carbon-14 forms naturally in Earth's atmosphere when cosmic rays strike atoms of nitrogen-14. Living things take in and use carbon-14, just as they do carbon-12. The carbon-14 in living things gradually decays to nitrogen-14. However, it is constantly replaced because living things keep taking in carbon-14. As a result, there is a fixed ratio of carbon-14 to carbon-12 in organisms as long as they are alive. This is illustrated in the top part of **Figure 11.10**.

After organisms die, the carbon-14 they already contain continues to decay, but it is no longer replaced (see bottom part of **Figure 11.10**). Therefore, the carbon-14 in a dead organism constantly declines at a fixed rate equal to the half-life of carbon-14. Half of the remaining carbon-14 decays every 5,730 years. If you measure how much carbon-14 is left in a fossil, you can determine how many half-lives (and how many years) have passed since the organism died.

Carbon-14 and Living Things

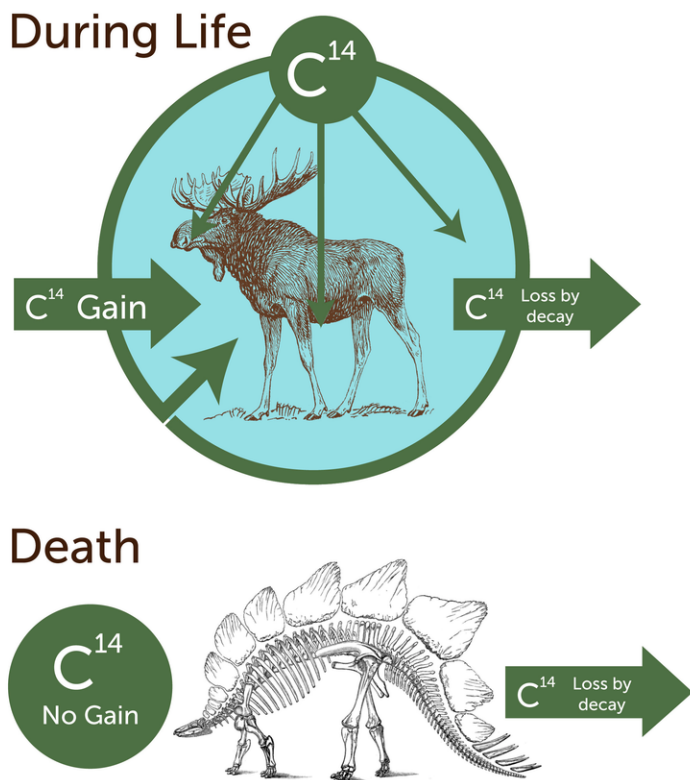

FIGURE 11.10

After organisms die, the carbon-14 they contain is lost at a constant rate.

Limit on Carbon-14 Dating

Carbon-14 has a relatively short half-life (see **Table 11.1**). After about 50,000 years, too little carbon-14 is left in a fossil to be measured. Therefore, carbon-14 dating can only be used to date fossils that are less than 50,000 years old. Radioisotopes with a longer half-life, such as potassium-40, must be used to date older fossils and rocks.

Lesson Summary

- Radioactive decay is the process in which unstable nuclei become stable by emitting particles and energy and changing to different elements. There are three types of radioactive decay: alpha, beta, and gamma decay. Each differs in what is emitted, how far it can travel, and what it can penetrate.
- The rate of radioactive decay varies from one radioisotope to another. The rate is measured by the half-life. This is the length of time it takes for half of a given amount of a radioisotope to decay.
- Radioactive dating is the use of radioactive decay to estimate the ages of fossils and rocks. An example is carbon-14 dating.

Lesson Review Questions

Recall

1. What is radioactive decay?
2. Define half-life.
3. Which type of radioactive decay is represented by each of the following nuclear equations?
 - a. ${}_{27}^{60}\text{Co} \rightarrow {}_{28}^{60}\text{Ni} + {}_{-1}^0e + \text{Energy}$
 - b. ${}_{106}^{263}\text{Sg} \rightarrow {}_{104}^{259}\text{Rf} + {}_2^4\text{He} + \text{Energy}$

Apply Concepts

4. Complete the following nuclear equation. First add the missing subscript. Then use the periodic table in **Figure 11.2** to identify the unknown element (X). ${}_{85}^{211}\text{At} \rightarrow {}_7^{207}\text{X} + {}_2^4\text{He} + \text{Energy}$
5. Create a model to demonstrate the concept of the half-life of a radioisotope.
6. Assume that a fossil contains one-eighth of the carbon-14 that was present in the organism when it was alive. How long has it been since the organism died?

Think Critically

7. Compare and contrast alpha, beta, and gamma decay.

Points to Consider

Radioactive decay releases energy. Other types of nuclear reactions also release energy.

- What other types of reactions might the nucleus undergo?
- What might be the pros and cons of using nuclear reactions for energy?

11.3 Nuclear Energy

Lesson Objectives

- Describe nuclear fission and how it is used for energy.
- Describe nuclear fusion and challenges to its use for energy.
- Relate nuclear energy to Einstein's equation, $E = mc^2$.

Lesson Vocabulary

- nuclear energy
- nuclear fission
- nuclear fusion

Introduction

Nuclear energy is the energy released in nuclear reactions. Two types of reactions that release huge amounts of energy are nuclear fission and nuclear fusion.

Energy from Nuclear Fission

Nuclear fission is the splitting of the nucleus of an atom into two smaller nuclei. This type of reaction releases a great deal of energy from a very small amount of matter. For example, nuclear fission of a tiny pellet of uranium-235, like the one pictured in **Figure 11.11**, can release as much energy as burning 1,000 kilograms of coal!

Nuclear fission of uranium-235 can be represented by this equation:

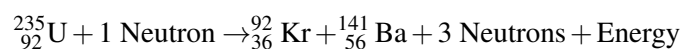

As shown in **Figure 11.12**, the reaction begins when a nucleus of uranium-235 absorbs a neutron. This can happen naturally or when a neutron is deliberately crashed into a uranium nucleus in a nuclear power plant. In either case, the nucleus of uranium becomes very unstable and splits in two. In this example, it forms krypton-92 and barium-141. The reaction also releases three neutrons and a great deal of energy.

Nuclear Chain Reaction

The neutrons released in this nuclear fission reaction may be captured by other uranium nuclei and cause them to fission as well. This can start a nuclear chain reaction (see **Figure 11.13**). In a chain reaction, one fission reaction

Uranium-235

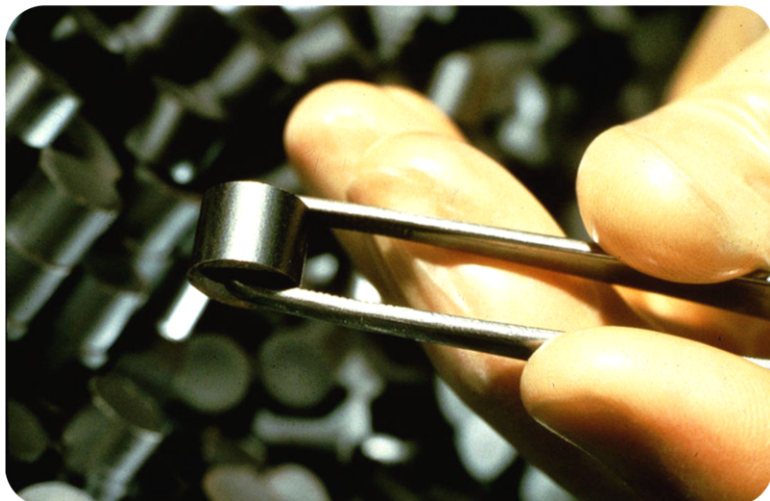

FIGURE 11.11

This pellet of uranium-235 can release a huge amount of energy if it undergoes nuclear fission.

Nuclear Fission

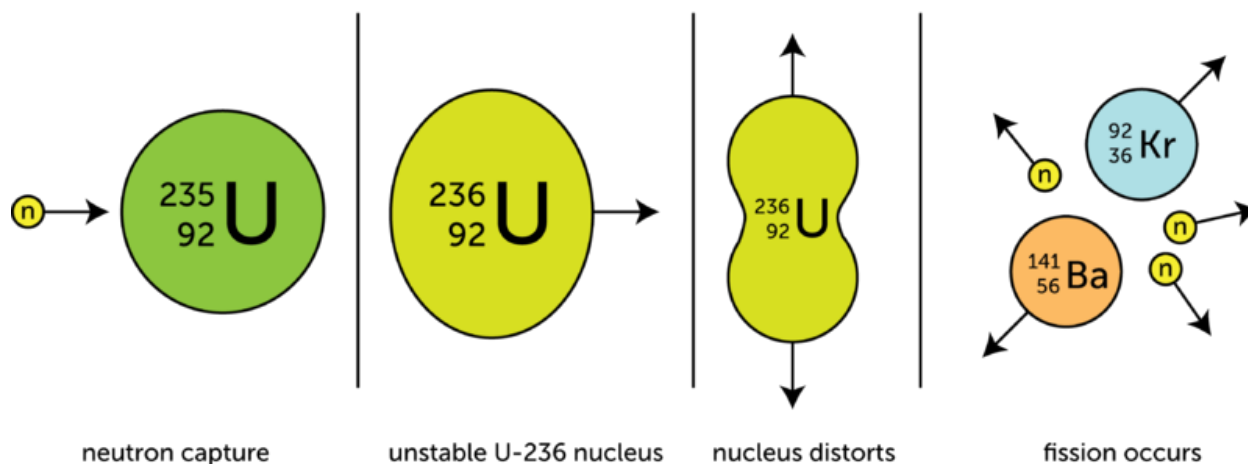

FIGURE 11.12

The fissioning of a nucleus of uranium-235 begins when it captures a neutron.

leads to others, which lead to others, and so on. A nuclear chain reaction is similar to a pile of wood burning. If you start one piece of wood burning, enough heat is produced by the burning wood to start the rest of the pile burning without any further help from you. You can see another example of a chain reaction at this URL: <http://www.youtube.com/watch?v=0v8i4v1mieU> (2:54).

**MEDIA**

Click image to the left for more content.

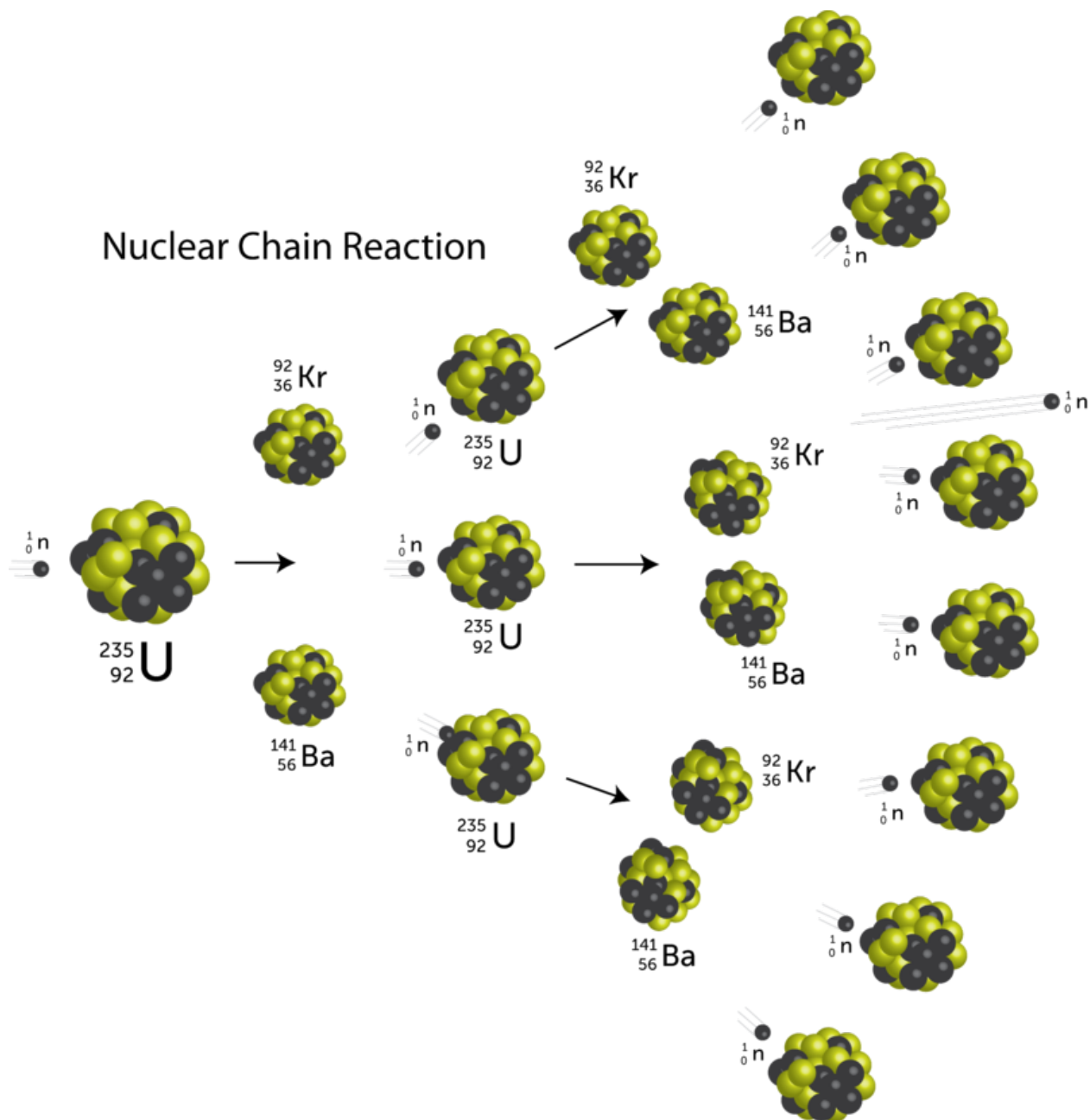
**FIGURE 11.13**

In a nuclear chain reaction, each nuclear reaction leads to more nuclear reactions.

Using Energy from Nuclear Fission

If a nuclear chain reaction is uncontrolled, it produces a lot of energy all at once. This is what happens in an atomic bomb. If a nuclear chain reaction is controlled, it produces energy more slowly. This is what occurs in a nuclear power plant. The reaction may be controlled by inserting rods of material that do not undergo fission into the core of fissioning material (see **Figure 11.14**). The radiation from the controlled fission is used to heat water and turn it to steam. The steam is under pressure and causes a turbine to spin. The spinning turbine runs a generator, which produces electricity.

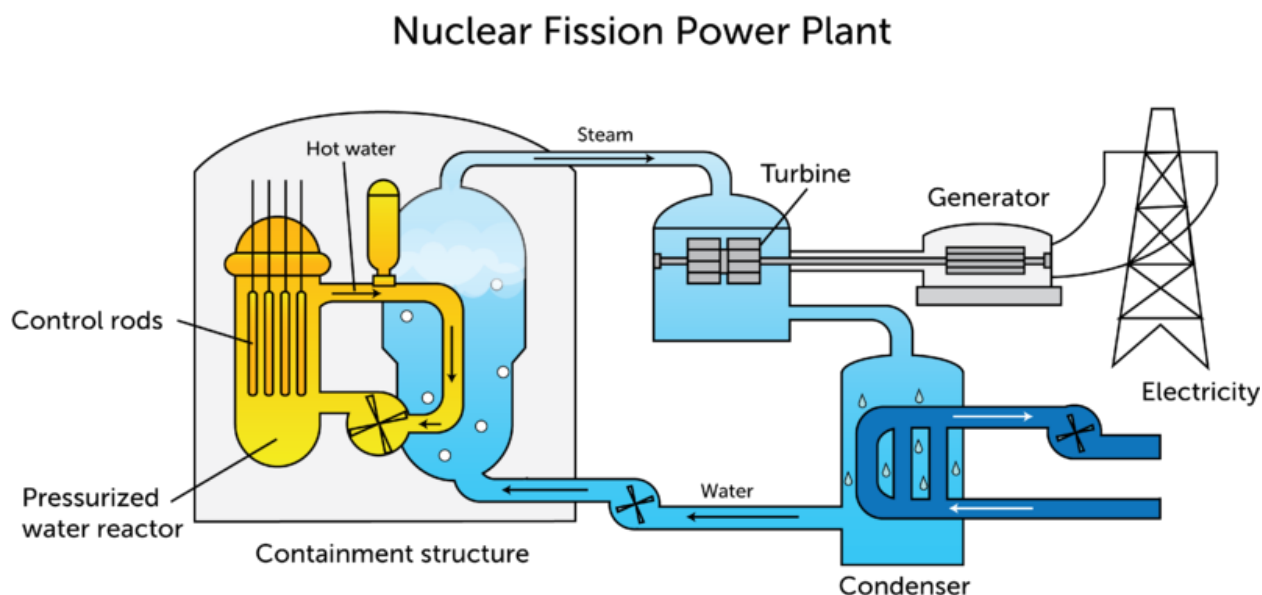

FIGURE 11.14

This diagram shows the main parts of a nuclear power plant.

Pros and Cons of Nuclear Fission

In the U.S., the majority of electricity is produced by burning coal or other fossil fuels. This causes air pollution, acid rain, and global warming. Fossil fuels are also limited and may eventually run out. Like fossil fuels, radioactive elements are limited. In fact, they are relatively rare, so they could run out sooner rather than later. On the other hand, nuclear fission does not release air pollution or cause the other environmental problems associated with burning fossil fuels. This is the major advantage of using nuclear fission as a source of energy.

The main concern over the use of nuclear fission is the risk of radiation. Accidents at nuclear power plants can release harmful radiation that endangers people and other living things. Even without accidents, the used fuel that is left after nuclear fission reactions is still radioactive and very dangerous. It takes thousands of years for it to decay until it no longer releases harmful radiation. Therefore, used fuel must be stored securely to people and other living things. You can learn more about the problem of radioactive waste at this URL: <http://www.youtube.com/watch?v=OPQ97LVRuuM>.

Energy from Nuclear Fusion

Nuclear fusion is the opposite of nuclear fission. In fusion, two or more small nuclei combine to form a single, larger nucleus. An example is shown in **Figure 11.15**. In this example, two hydrogen nuclei fuse to form a helium nucleus. A neutron and a great deal of energy are also released. In fact, fusion releases even more energy than fission does.

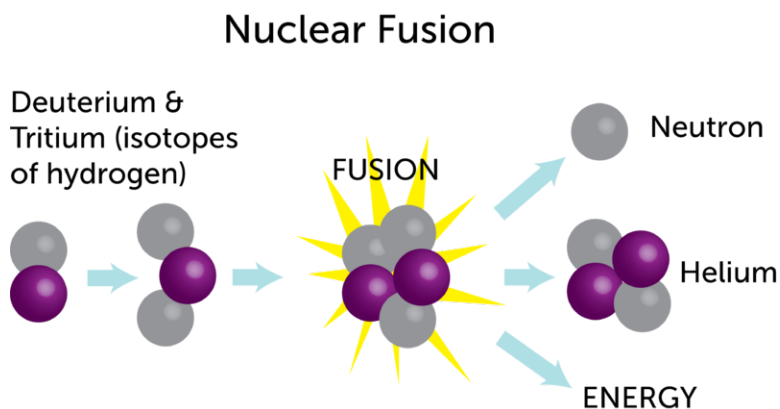

FIGURE 11.15

In this nuclear fusion reaction, nuclei of two hydrogen isotopes (tritium and deuterium) fuse together. They form a helium nucleus, a neutron, and energy.

The Power of Stars

Nuclear fusion of hydrogen to form helium occurs naturally in the sun and other stars. It takes place only at extremely high temperatures. That's because a great deal of energy is needed to overcome the force of repulsion between positively charged nuclei. The sun's energy comes from fusion in its core, where temperatures reach millions of Kelvin (see **Figure 11.16**).

Using Nuclear Fusion

Scientists are searching for ways to create controlled nuclear fusion reactions on Earth. Their goal is develop nuclear fusion power plants, where the energy from fusion of hydrogen nuclei can be converted to electricity. How this might work is shown in **Figure 11.17**.

The use of nuclear fusion for energy has several pros. Unlike nuclear fission, which involves dangerous radioisotopes, nuclear fusion involves hydrogen and helium. These elements are harmless. Hydrogen is also very plentiful. There is a huge amount of hydrogen in ocean water. The hydrogen in just a gallon of water could produce as much energy by nuclear fusion as burning 1,140 liters (300 gallons) of gasoline! The hydrogen in the oceans would generate enough energy to supply all the world's people for a very long time.

Unfortunately, using energy from nuclear fusion is far from a reality. Scientists are a long way from developing the necessary technology. One problem is raising temperatures high enough for fusion to take place. Another problem is that matter this hot exists only in the plasma state. There are no known materials that can contain plasma, although a magnet might be able to do it. That's because plasma consists of ions and responds to magnetism. You can learn more about research on nuclear fusion at the URL below.

<http://www.youtube.com/watch?v=3C5hFQeZCT4>

The Sun

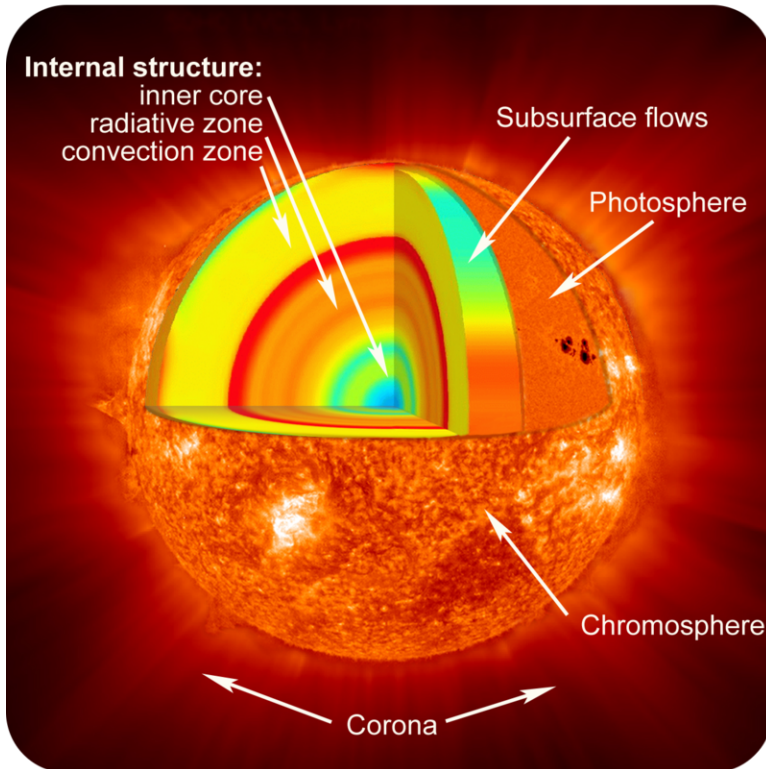

FIGURE 11.16

The extremely hot core of the sun radiates energy from nuclear fusion.

Fusion Reactions

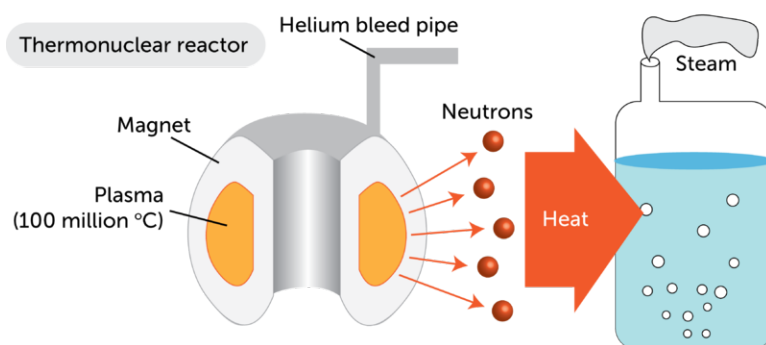

FIGURE 11.17

In the thermonuclear reactor modeled here, radiation from fusion is used to heat water and form steam. The steam can then be used to turn a turbine and generate electricity.

Nuclear Energy and Einstein's Famous Equation

Probably the most famous equation in the world is $E = mc^2$. You may have heard of it. You may have even seen it on a tee shirt or coffee mug. It's a simple equation that was derived in 1905 by the physicist Albert Einstein (see **Figure 11.18**). Although the equation is simple, it is incredibly important. It changed how scientists view two of the most basic concepts in science: matter and energy. The equation shows that matter and energy are two forms of the same thing. It also shows how matter and energy are related. In addition, Einstein's equation explains why nuclear

fission and nuclear fusion produce so much energy.

Albert Einstein

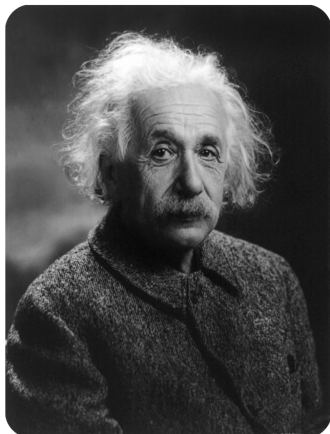
**FIGURE 11.18**

Albert Einstein is considered by many to be the greatest physicist of all time.

You can listen to a recording of Einstein explaining his famous equation at this URL: <http://www.youtube.com/watch?v=CC7Sg41Bp-U> .

What Einstein's Equation Means

In Einstein's equation, the variable E stands for energy and the variable m stands for mass. The c in the equation is a constant. It stands for the speed of light. The speed of light is 300,000 kilometers (186,000 miles) per second, so c^2 is a very big number, no matter what units are used to measure it. Einstein's equation means that the energy in a given amount of matter is equal to its mass times the square of the speed of light. That's a huge amount of energy from even a tiny amount of mass. Suppose, for example, that you have 1 gram of matter. That's about the mass of a paperclip. Multiplying that mass by the square of the speed of light yields enough energy to power 3,600 homes for a year!

Mass and Energy in Nuclear Reactions

When the nucleus of a radioisotope undergoes fission or fusion, it loses a tiny amount of mass. What happens to the lost mass? It isn't really lost at all. It is converted to energy. How much energy? $E = mc^2$. The change in mass is tiny, but it results in a great deal of energy.

What about the laws of conservation of mass and conservation of energy? Do they not apply to nuclear reactions? We don't need to throw out these laws. Instead, we just need to combine them. It is more correct to say that the sum of mass and energy is always conserved in a nuclear reaction. Mass may change to energy, but the amount of mass and energy combined remains the same.

Lesson Summary

- Nuclear fission is the splitting of the nucleus of an atom into two smaller nuclei. This releases a great deal of energy. Nuclear power plants use the energy from nuclear fission to generate electricity.
- Nuclear fusion is the fusing of two or more smaller nuclei to form a single, larger nucleus. Fusion releases even more energy than fission. Researchers are trying to find a way to use the energy from nuclear fusion to generate electricity.

- Einstein's equation, $E = mc^2$, shows that matter and energy are two forms of the same thing. In nuclear fission and nuclear fusion, a tiny amount of matter changes to a huge amount of energy. The amount of energy equals the mass of the "lost" matter times the square of the speed of light.

Lesson Review Questions

Recall

1. Describe how nuclear fission occurs.
2. What is a nuclear chain reaction?
3. Outline what happens during nuclear fusion.
4. What are advantages of using nuclear fusion as opposed to nuclear fission for energy?

Apply Concepts

5. Create a flowchart to show how nuclear fission is used to generate electricity.

Think Critically

6. Relate Einstein's equation, $E = mc^2$, to the energy released in nuclear fission and nuclear fusion.
7. Less than one-quarter of the electricity used in the U.S. is generated from nuclear energy. Some people think we should use more nuclear power. Other people think we should use less or even none at all. Take a stand on this issue, and present facts and logical arguments to support your point of view.

Points to Consider

Einstein's equation is part of a larger theory called the theory of relativity. It is concerned with concepts such as motion and forces as well as mass and energy. Motion and forces are the focus of succeeding chapters.

- Based on your real-world experiences, how would you define motion?
- Forces include gravity and friction. How might these forces be related to motion?

11.4 References

1. Adrian Barnes. <http://www.flickr.com/photos/adrianrbarnes/222098051/> . CC BY 2.0
2. Christopher Auyeung. [CK-12 Foundation](#) . CC BY-NC 3.0
3. Mad House Photography. http://www.flickr.com/photos/mad_house_photography/4426998415/ . CC BY 2.0
4. Tim Vickers. http://commons.wikimedia.org/wiki/File:Geiger_counter_2.jpg . Public Domain
5. Courtesy of Chief Warrant Officer 4 Seth Rossman/US Navy. http://commons.wikimedia.org/wiki/File:US_Navy_030819-N-9593R-151_A_patient_goes_through_Positron_Emission_Tomography,_%28PET%29_at_the_National_Naval_Medical_Center_in_Bethesda,_Maryland.jpg . Public Domain
6. Christopher Auyeung. [CK-12 Foundation](#) . CC BY-NC 3.0
7. Christopher Auyeung. [CK-12 Foundation](#) . CC BY-NC 3.0
8. User:Penubag/Wikimedia Commons. <http://commons.wikimedia.org/wiki/File:RadiationPenetration2-pn.png> . Public Domain
9. Christopher Auyeung. [CK-12 Foundation](#) . CC BY-NC 3.0
10. Laura Guerin. [CK-12 Foundation](#) . CC BY-NC 3.0
11. Courtesy of the US Nuclear Regulatory Commission. <http://www.nrc.gov/images/reading-rm/photo-gallery/20071114-022.jpg> . Public Domain
12. Christopher Auyeung. [CK-12 Foundation](#) . CC BY-NC 3.0
13. Christopher Auyeung. [CK-12 Foundation](#) . CC BY-NC 3.0
14. Christopher Auyeung. [CK-12 Foundation](#) . CC BY-NC 3.0
15. Christopher Auyeung. [CK-12 Foundation](#) . CC BY-NC 3.0
16. Courtesy of NASA. http://www.nasa.gov/mission_pages/hinode/solar_020.html . Public Domain
17. Christopher Auyeung. [CK-12 Foundation](#) . CC BY-NC 3.0
18. Photograph by Oren Jack Turner, Princeton, N.J., cleaned by User:Jaakobou/Wikimedia Commons. http://commons.wikimedia.org/wiki/File:Albert_Einstein_Head_cleaned.jpg . Public Domain

CHAPTER 12

Motion

Chapter Outline

- 12.1 DISTANCE AND DIRECTION
- 12.2 SPEED AND VELOCITY
- 12.3 ACCELERATION
- 12.4 REFERENCES



A frog flicks out its long tongue to catch insects. In this photo, you can't actually see the frog's tongue moving. But even if you were to witness it in person, you still wouldn't be able to see it. That's because a frog's tongue moves incredibly fast. It travels out and back in about 0.15 seconds, too fast for the human eye to detect. Other organisms can also move at very high speeds. For example, the fastest land animal, the cheetah, can sprint at an amazing 120 kilometers (75 miles) per hour. Speed is one way of measuring motion. What is motion, and what are other ways of measuring it? In this chapter, you'll find out.

Opening image copyright Cathy Keifer, 2013. www.shutterstock.com. Used under license from Shutterstock.com.

12.1 Distance and Direction

Lesson Objectives

- Define motion, and relate it to frame of reference.
- Describe how to measure distance.
- Explain how to represent direction.

Lesson Vocabulary

- distance
- frame of reference
- motion
- vector

Introduction

You can see several examples of people or things in motion in **Figure 12.1**. You can probably think of many other examples. You know from experience what motion is, so it may seem like a straightforward concept. **Motion** can also be defined simply, as a change in position. But if you think about examples of motion in more depth, you'll find that the idea of motion is not quite as simple and straightforward as it seems.

Frame of Reference

Assume that a school bus, like the one in **Figure 12.2**, passes by as you stand on the sidewalk. It's obvious to you that the bus is moving. It is moving relative to you and the trees across the street. But what about to the children inside the bus? They aren't moving relative to each other. If they look only at the other children sitting near them, they will not appear to be moving. They may only be able to tell that the bus is moving by looking out the window and seeing you and the trees whizzing by.

This example shows that how we perceive motion depends on our frame of reference. **Frame of reference** refers to something that is not moving with respect to an observer that can be used to detect motion. For the children on the bus, if they use other children riding the bus as their frame of reference, they do not appear to be moving. But if they use objects outside the bus as their frame of reference, they can tell they are moving. What is your frame of reference if you are standing on the sidewalk and see the bus go by? How can you tell the bus is moving? The video at the URL below illustrates other examples of how frame of reference is related to motion.

<http://www.youtube.com/watch?v=7FYBG5GskIU> (6:45)



FIGURE 12.1

These are just a few examples of people or things in motion. If you look around, you're likely to see many more.



When a bus passes someone standing on the sidewalk, it momentarily blocks the person's view of objects across the street. This helps the outside observer detect the bus's motion.

If the ride is smooth enough, this child may not even realize that the bus is moving unless he looks out the windows.

FIGURE 12.2

To a person outside the bus, the bus's motion is obvious. To children riding the bus, its motion may not be as obvious.



MEDIA

Click image to the left for more content.

Distance

Did you ever go to a track meet like the one pictured in **Figure 12.3**? Running events in track include 100-meter sprints and 2000-meter races. Races are named for their distance. **Distance** is the length of the route between two points. The length of the route in a race is the distance between the starting and finishing lines. In a 100-meter sprint, for example, the distance is 100 meters.



FIGURE 12.3

These students are running a 100-meter sprint.

SI Unit for Distance

The SI unit for distance is the meter ($1 \text{ m} = 3.28 \text{ ft}$). Short distances may be measured in centimeters ($1 \text{ cm} = 0.01 \text{ m}$). Long distances may be measured in kilometers ($1 \text{ km} = 1000 \text{ m}$). For example, you might measure the distance a frog's tongue moves in centimeters and the distance a cheetah moves in kilometers.

Using Maps to Measure Distance

Maps can often be used to measure distance. Look at the map in **Figure 12.4**. Find Mia's house and the school. You can use the map key to directly measure the distance between these two points. The distance is 2 kilometers. Measure it yourself to see if you agree.

Direction

Things don't always move in straight lines like the route from Mia's house to the school. Sometimes they change direction as they move. For example, the route from Mia's house to the post office changes from west to north at the school (see **Figure 12.4**). To find the total distance of a route that changes direction, you must add up the distances traveled in each direction. From Mia's house to the school, for example, the distance is 2 kilometers. From the school to the post office, the distance is 1 kilometer. Therefore, the total distance from Mia's house to the post office is 3 kilometers.

You Try It!

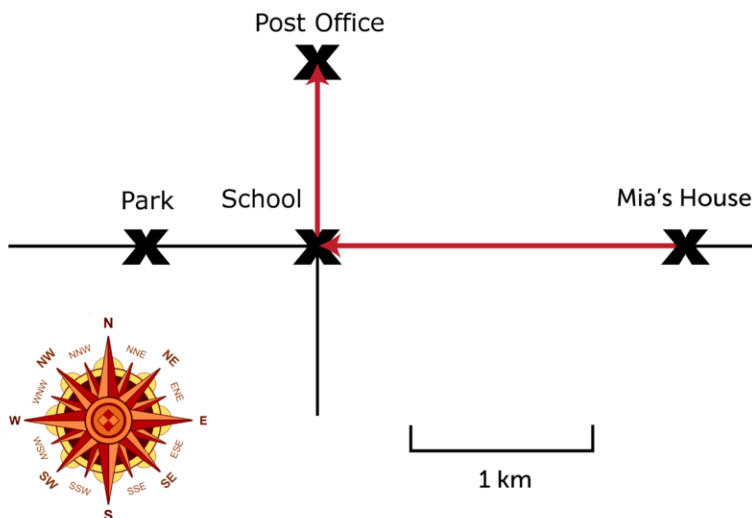

FIGURE 12.4

This map shows the routes from Mia's house to the school, post office, and park.

Problem: What is the distance from the post office to the park in **Figure 12.4**?

Direction is just as important as distance in describing motion. For example, if Mia told a friend how to reach the post office from her house, she couldn't just say, "go 3 kilometers." The friend might end up at the park instead of the post office. Mia would have to be more specific. She could say, "go west for 2 kilometers and then go north for 1 kilometer." When both distance and direction are considered, motion is a vector. A **vector** is a quantity that includes both size and direction. A vector is represented by an arrow. The length of the arrow represents distance. The way the arrow points shows direction. The red arrows in **Figure 12.4** are vectors for Mia's route to the school and post office. If you want to learn more about vectors, watch the videos at these URLs:

- <http://www.youtube.com/watch?v=B-iBbcFwFOk> (5:27)

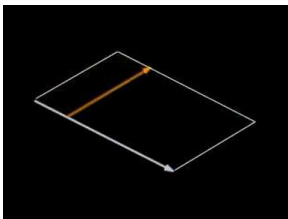

MEDIA

Click image to the left for more content.

- <http://www.youtube.com/watch?v=tSOz3xaHKLs>

You Try It!

Problem: Draw vectors to represent the route from the post office to the park in **Figure 12.4**.

Lesson Summary

- Motion is a change of position. The perception of motion depends on a person's frame of reference.
- Distance is the length of the route between two points. The SI unit for distance is the meter (m).
- Direction is just as important as distance in describing motion. A vector is a quantity that has both size and direction. It can be used to represent the distance and direction of motion.

Lesson Review Questions

Recall

1. Define motion.
2. What is distance?
3. Describe how a vector represents distance and direction.

Apply Concepts

4. In **Figure 12.4**, what is the distance from Mia's house to the park?
5. Draw vectors to represent the following route from point A to point B:
 - a. Starting at point A, go 2 km east.
 - b. Then go 1 km south.
 - c. Finally, go 3 km west to point B.

Think Critically

6. Explain how frame of reference is related to motion.

Points to Consider

A snail might travel 2 centimeters in a minute. A cheetah might travel 2 kilometers in the same amount of time. The distance something travels in a given amount of time is its speed.

- How could you calculate the speed of a snail or cheetah?
- Speed just takes distance and time into account. How might direction be considered as well?

12.2 Speed and Velocity

Lesson Objectives

- Outline how to calculate the speed of a moving object.
- Explain how velocity differs from speed.

Lesson Vocabulary

- speed
- velocity

Introduction

Did you ever play fast-pitch softball? If you did, then you probably have some idea of how fast the pitcher throws the ball. For a female athlete, like the one in **Figure 12.5**, the ball may reach a speed of 120 km/h (about 75 mi/h). For a male athlete, the ball may travel even faster. The speed of the ball makes it hard to hit. If the ball changes course, the batter may not have time to adjust the swing to meet the ball.



FIGURE 12.5

In fast-pitch softball, the pitcher uses a "windmill" motion to throw the ball. This is a different technique than other softball pitches. It explains why the ball travels so fast.

Speed

Speed is an important aspect of motion. It is a measure of how fast or slow something moves. It depends on how far something travels and how long it takes to travel that far. Speed can be calculated using this general formula:

$$\text{speed} = \frac{\text{distance}}{\text{time}}$$

A familiar example is the speed of a car. In the U.S., this is usually expressed in miles per hour (see **Figure 12.6**). If your family makes a car trip that covers 120 miles and takes 3 hours, then the car's speed is:

$$\text{speed} = \frac{120 \text{ mi}}{3 \text{ h}} = 40 \text{ mi/h}$$

The speed of a car may also be expressed in kilometers per hour (km/h). The SI unit for speed is meters per second (m/s).



FIGURE 12.6

Speed limit signs like this one warn drivers to reduce their speed on dangerous roads.

Instantaneous vs. Average Speed

When you travel by car, you usually don't move at a constant speed. Instead you go faster or slower depending on speed limits, traffic, traffic lights, and many other factors. For example, you might travel 65 miles per hour on a highway but only 20 miles per hour on a city street (see **Figure 12.7**). You might come to a complete stop at traffic lights, slow down as you turn corners, and speed up to pass other cars. The speed of a moving car or other object at a given instant is called its instantaneous speed. It may vary from moment to moment, so it is hard to calculate.

It's easier to calculate the average speed of a moving object than the instantaneous speed. The average speed is the total distance traveled divided by the total time it took to travel that distance. To calculate the average speed, you can use the general formula for speed that was given above. Suppose, for example, that you took a 75-mile car trip with your family. Your instantaneous speed would vary throughout the trip. If the trip took a total of 1.5 hours, your average speed for the trip would be:



FIGURE 12.7

Cars race by in a blur of motion on an open highway but crawl at a snail's pace when they hit city traffic.

$$\text{average speed} = \frac{75 \text{ mi}}{1.5 \text{ h}} = 50 \text{ mi/h}$$

You can see a video about instantaneous and average speed and how to calculate them at this URL: <http://www.youtube.com/watch?v=a8tIBrj84II> (7:18).

EQUATION for AVERAGE SPEED

- **average speed** $= v_{av}$ — is the total distance divided by the total time for the trip
- Therefore speed v is distance, d , divided by the time t .

$$v_{av} = \frac{\Delta d}{\Delta t}$$

v_{av} = "average speed"
 Δd = "change in distance"
 Δt = "change in time"

MEDIA

Click image to the left for more content.

You Try It!

Problem: Terri rode her bike very slowly to the top of a big hill. Then she coasted back down the hill at a much faster speed. The distance from the bottom to the top of the hill is 3 kilometers. It took Terri 15 minutes to make the round trip. What was her average speed for the entire trip?

Distance-Time Graphs

The motion of an object can be represented by a distance-time graph like the one in **Figure 12.8**. A distance-time graph shows how the distance from the starting point changes over time. The graph in **Figure 12.8** represents a bike trip. The trip began at 7:30 AM (A) and ended at 12:30 PM (F). The rider traveled from the starting point to a destination and then returned to the starting point again.

Slope Equals Speed

In a distance-time graph, the speed of the object is represented by the slope, or steepness, of the graph line. If the line is straight, like the line between A and B in **Figure 12.8**, then the speed is constant. The average speed can be calculated from the graph. The change in distance (represented by Δd) divided by the change in time (represented by Δt):

$$\text{speed} = \frac{\Delta d}{\Delta t}$$

For example, the speed between A and B in **Figure 12.8** is:

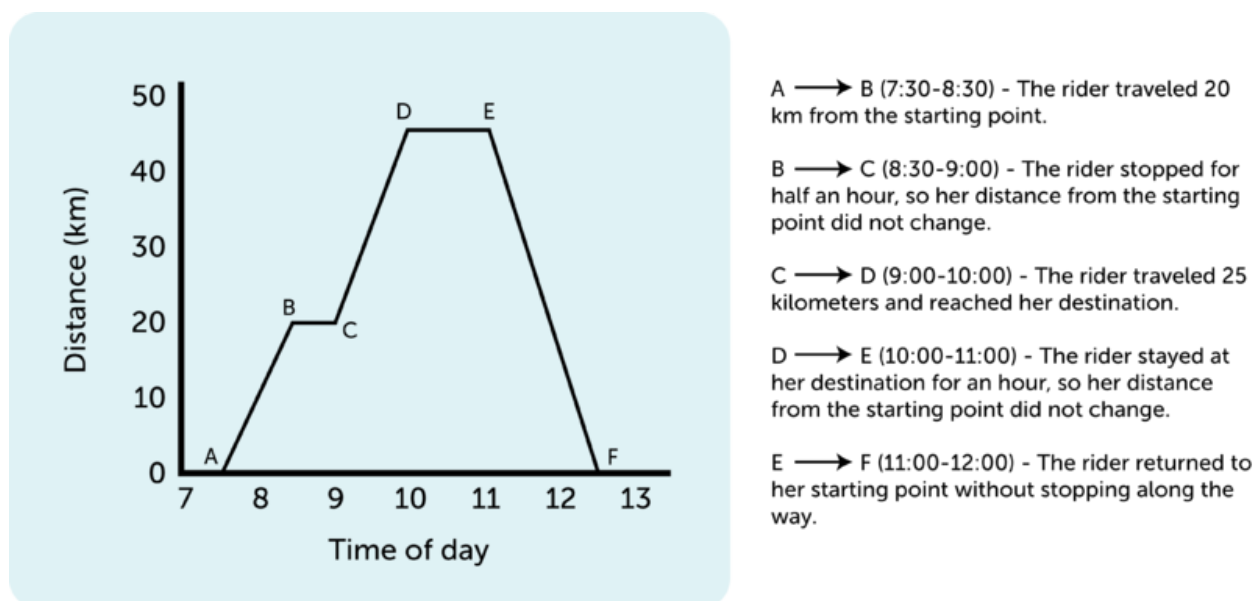

FIGURE 12.8

This graph shows how far a bike rider is from her starting point at 7:30 AM until she returned at 12:30 PM.

$$\text{speed} = \frac{\Delta d}{\Delta t} = \frac{20 \text{ km} - 0 \text{ km}}{8:30 - 7:30 \text{ h}} = \frac{20 \text{ km}}{1 \text{ h}} = 20 \text{ km/h}$$

If the graph line is horizontal, as it is between B and C, then the slope and the speed are zero:

$$\text{speed} = \frac{\Delta d}{\Delta t} = \frac{20 \text{ km} - 20 \text{ km}}{9:00 - 8:30 \text{ h}} = \frac{0 \text{ km}}{0.5 \text{ h}} = 0 \text{ km/h}$$

You Try It!

Problem: In **Figure 12.8**, calculate the speed of the rider between C and D.

Calculating Distance from Speed and Time

If you know the speed of a moving object, you can also calculate the distance it will travel in a given amount of time. To do so, you would use this version of the general speed formula:

$$\text{distance} = \text{speed} \times \text{time}$$

For example, if a car travels at a speed of 60 km/h for 2 hours, then the distance traveled is:

$$\text{distance} = 60 \text{ km/h} \times 2 \text{ h} = 120 \text{ km}$$

You Try It!

Problem: If Maria runs at a speed of 2 m/s, how far will she run in 60 seconds?

Velocity

Speed tells you only how fast an object is moving. It doesn't tell you the direction the object is moving. The measure of both speed and direction is called **velocity**. Velocity is a vector that can be represented by an arrow. The length of the arrow represents speed, and the way the arrow points represents direction. The three arrows in **Figure 12.9** represent the velocities of three different objects. Vectors A and B are the same length but point in different directions. They represent objects moving at the same speed but in different directions. Vector C is shorter than vector A or B but points in the same direction as vector A. It represents an object moving at a slower speed than A or B but in the same direction as A. If you're still not sure of the difference between speed and velocity, watch the cartoon at this URL: <http://www.youtube.com/watch?v=mDcaeOOWxBI> (2:10).

**MEDIA**

Click image to the left for more content.

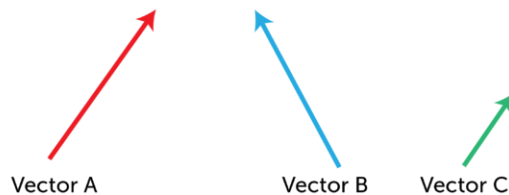
**FIGURE 12.9**

These vectors show both the speed and direction of motion.

In general, if two objects are moving at the same speed and in the same direction, they have the same velocity. If two objects are moving at the same speed but in different directions (like A and B in **Figure 12.9**), they have different velocities. If two objects are moving in the same direction but at a different speed (like A and C in **Figure 12.9**), they have different velocities. A moving object that changes direction also has a different velocity, even if its speed does not change.

Lesson Summary

- Speed is a measure of how fast or slow something moves. It depends on the distance traveled and how long it takes to travel that distance. The average speed of an object is calculated as the change in distance divided by the change in time.
- Velocity is a measure of both speed and direction. It is a vector that can be represented by an arrow. Velocity changes with a change in speed, a change in direction, or both.

Lesson Review Questions

Recall

1. What is speed? How is it calculated?
2. Define velocity.

Apply Concepts

3. Sam ran a 2000-meter race. He started at 9:00 AM and finished at 9:05 AM. He started out fast but slowed down toward the end. Calculate Sam's average speed during the race.
4. Create a distance-time graph to represent a typical trip from your home to school or some other route you travel often. You may estimate distances and times.

Think Critically

5. Explain how a distance-time graph represents speed.
6. Compare and contrast speed and velocity.
7. Is speed a vector? Why or why not?

Points to Consider

In this chapter, you read that the speed of a moving object equals the distance traveled divided by the time it takes to travel that distance. Speed may vary from moment to moment as an object speeds up or slows down. In the next lesson, "Acceleration," you will learn how to measure changes in speed over time.

- Do you know what a change in speed or direction is called?
- Why might measuring changes in speed or direction be important?

12.3 Acceleration

Lesson Objectives

- Define acceleration.
- Explain how to calculate acceleration.
- Describe velocity-time graphs.

Lesson Vocabulary

- acceleration

Introduction

Imagine the thrill of riding on a roller coaster like the one in **Figure 12.10**. The coaster crawls to the top of the track and then flies down the other side. It also zooms around twists and turns at breakneck speeds. These changes in speed and direction are what make a roller coaster ride so exciting. Changes in speed or direction are called **acceleration**.



FIGURE 12.10

Did you ever ride on a roller coaster like this one? It's called the "Blue Streak" for a reason. As it speeds around the track, it looks like a streak of blue.

Defining Acceleration

Acceleration is a measure of the change in velocity of a moving object. It shows how quickly velocity changes. Acceleration may reflect a change in speed, a change in direction, or both. Because acceleration includes both a size (speed) and direction, it is a vector.

People commonly think of acceleration as an increase in speed, but a decrease in speed is also acceleration. In this case, acceleration is negative. Negative acceleration may be called deceleration. A change in direction without a change in speed is acceleration as well. You can see several examples of acceleration in **Figure 12.11**.

Riding a Carousel



Falling Freely



Crossing a Finish Line



Spinning a Basketball



Launching a Model Rocket

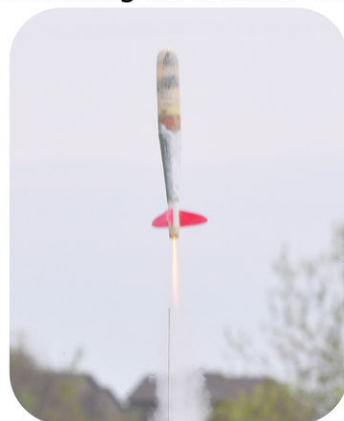

Hitting a Baseball



FIGURE 12.11

How is velocity changing in each of these pictures?

If you are accelerating, you may be able to feel the change in velocity. This is true whether you change your speed or your direction. Think about what it feels like to ride in a car. As the car speeds up, you feel as though you are being pressed against the seat. The opposite occurs when the car slows down, especially if the change in speed is sudden. You feel yourself thrust forward. If the car turns right, you feel as though you are being pushed to the left. With a left turn, you feel a push to the right. The next time you ride in a car, notice how it feels as the car accelerates in each of these ways. For an interactive simulation about acceleration, go to this URL: <http://phet.colorado.edu/en/simulation/moving-man> .

Calculating Acceleration

Calculating acceleration is complicated if both speed and direction are changing. It's easier to calculate acceleration when only speed is changing. To calculate acceleration without a change in direction, you just divide the change in velocity (represented by Δv) by the change in time (represented by Δt). The formula for acceleration in this case is:

$$\text{Acceleration} = \frac{\Delta v}{\Delta t}$$

Consider this example. The cyclist in **Figure 12.12** speeds up as he goes downhill on this straight trail. His velocity changes from 1 meter per second at the top of the hill to 6 meters per second at the bottom. If it takes 5 seconds for him to reach the bottom, what is his acceleration, on average, as he flies down the hill?

$$\text{Acceleration} = \frac{\Delta v}{\Delta t} = \frac{6 \text{ m/s} - 1 \text{ m/s}}{5 \text{ s}} = \frac{5 \text{ m/s}}{5 \text{ s}} = \frac{1 \text{ m/s}}{1 \text{ s}} = 1 \text{ m/s}^2$$

In words, this means that for each second the cyclist travels downhill, his velocity increases by 1 meter per second (on average). The answer to this problem is expressed in the SI unit for acceleration: m/s^2 ("meters per second squared").



FIGURE 12.12

Gravity helps this cyclist increase his downhill velocity.

You Try It!

Problem: Tranh slowed his skateboard as he approached the street. He went from 8 m/s to 2 m/s in a period of 3 seconds. What was his acceleration?

Velocity-Time Graphs

The acceleration of an object can be represented by a velocity–time graph like the one in **Figure 12.13**. A velocity–time graph shows how velocity changes over time. It is similar to a distance–time graph except the y -axis represents

velocity instead of distance. The graph in **Figure 12.13** represents the velocity of a sprinter on a straight track. The runner speeds up for the first 4 seconds of the race, then runs at a constant velocity for the next 3 seconds, and finally slows to a stop during the last 3 seconds of the race.

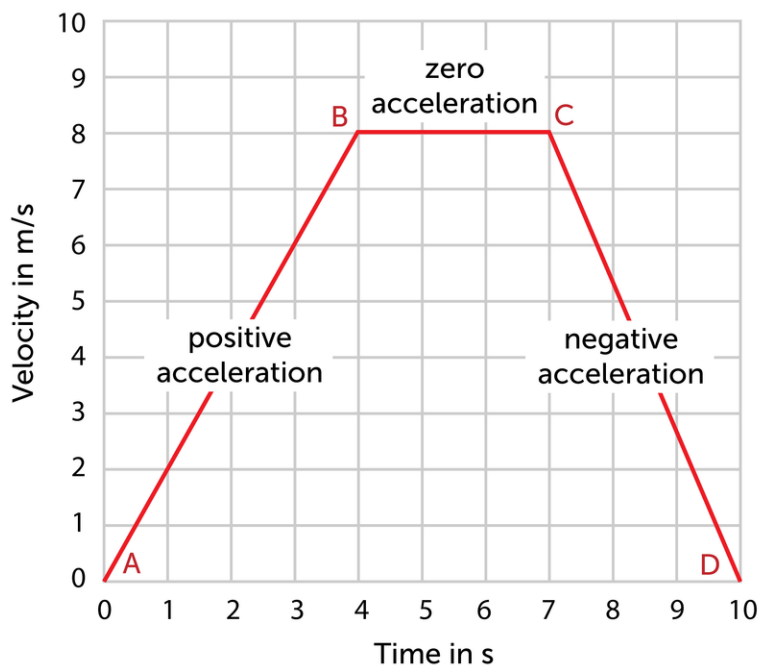

FIGURE 12.13

This graph shows how the velocity of a runner changes during a 10-second sprint.

In a velocity-time graph, acceleration is represented by the slope of the graph line. If the line slopes upward, like the line between A and B in **Figure 12.13**, velocity is increasing, so acceleration is positive. If the line is horizontal, as it is between B and C, velocity is not changing, so acceleration is zero. If the line slopes downward, like the line between C and D, velocity is decreasing, so acceleration is negative. You can review the concept of acceleration as well as other chapter concepts by watching the musical video at this URL: <http://www.youtube.com/watch?v=4CWlNoNpXCc> .

Lesson Summary

- Acceleration is a measure of the change in velocity of a moving object. It shows how quickly velocity changes and whether the change is positive or negative. It may reflect a change in speed, a change in direction, or both.
- To calculate acceleration without a change in direction, divide the change in velocity by the change in time.
- The slope of a velocity-time graph represents acceleration.

Lesson Review Questions

Recall

1. What is acceleration?
2. How is acceleration calculated?
3. What does the slope of a velocity-time graph represent?

Apply Concepts

4. The velocity of a car on a straight road changes from 0 m/s to 6 m/s in 3 seconds. What is its acceleration?

Think Critically

5. Because of the pull of gravity, a falling object accelerates at 9.8 m/s^2 . Create a velocity-time graph to represent this motion.

Points to Consider

Acceleration occurs when a force is applied to a moving object.

- What is force? What are some examples of forces?
- What forces might change the velocity of a moving object? (*Hint*: Read the caption to **Figure 12.12**.)

12.4 References

1. Train: John H. Gray; Cyclist: Flickr:DieselDemon; Inchworm: Clinton Charles Robertson; Hummingbird: Kevin Cole; Cartwheeler: Clemens v. Vogelsang (Flickr:vauvau); Meteor: Ed Sweeney (Flickr:Navicore).
Train: <http://www.flickr.com/photos/8391775@N05/3494460809/>; Cyclist: <http://www.flickr.com/photos/28096801@N05/3530472429/>; Inchworm: http://www.flickr.com/photos/dad_and_clint/3571033947/; Hummingbird: <http://www.flickr.com/photos/kevcote/2840250013/>; Cartwheeler: <http://www.flickr.com/photos/vauvau/8057026163/>; Meteor: <http://www.flickr.com/photos/edsweeney/4111291263/> . CC BY 2.0
2. Bus: Flickr:torbakhopper; Children: Flickr:woodleywonderworks. Bus: <http://www.flickr.com/photos/gazeronly/6904946218/>; Children: <http://www.flickr.com/photos/wwworks/2970993575/> . CC BY 2.0
3. Flickr:Blrframes. http://commons.wikimedia.org/wiki/File:Boys_track_and_field_in_Bangalore_India.jpg . CC BY 2.0
4. Christopher Auyeung (CK-12 Foundation); Compass: Seamus McGill. Compass: http://commons.wikimedia.org/wiki/File:Compass_rose_browns_00.png . CC BY-NC 3.0; Compass: Public Domain
5. Stuart Seeger. http://commons.wikimedia.org/wiki/File:Pitching_3.jpg . CC BY 2.0
6. User:Overpush/Wikimedia Commons. http://commons.wikimedia.org/wiki/File:MDSHA_W13-3.svg . Public Domain
7. Left: Flickr:äquinoktium; Right: Mario Roberto Duran Ortiz (Wikimedia: Mariordo). Left: <http://www.flickr.com/photos/44080248@N03/4053247185/>; Right: http://commons.wikimedia.org/wiki/File:Traffic_Congestion_Brasilia.jpg . Left: CC BY 2.0; Right: CC BY 3.0
8. Christopher Auyeung. [CK-12 Foundation](#) . CC BY-NC 3.0
9. Christopher Auyeung (CK-12 Foundation); Compass: Seamus McGill. Compass: http://commons.wikimedia.org/wiki/File:Compass_rose_browns_00.png . CC BY-NC 3.0; Compass: Public Domain
10. Flickr:daveynin. <http://www.flickr.com/photos/daveynin/7578666866/> . CC BY 2.0
11. Carousel: Jef Fisher; Skydiver: User:Degrer/Wikimedia Commons; Runner: Mike Spille; Basketball: Maurice Dayao/U.S. Navy; Model rocket: Flickr:kansasphoto; Baseball: Flickr:MyBiggestFan. Carousel: <http://www.flickr.com/photos/jeffisher/4839746434/>; Skydiver: <http://commons.wikimedia.org/wiki/File:SkydiveroverEslövSweden.jpg>; Runner: http://commons.wikimedia.org/wiki/File:NOLA_Marathon_2010_Crossing_Finish_Line.jpg; Basketball: [http://commons.wikimedia.org/wiki/File:US_Navy_080616-N-3581D-208_Ensign_Ian_Hochstein,_assigned_to_the_frigate_USS_Ford_\(FFG_54\),_teaches_a_young_girl_to_spin_a_basketball_at_the_Ban_Kao_Chan_Primary_School_in_Sattahip.jpg](http://commons.wikimedia.org/wiki/File:US_Navy_080616-N-3581D-208_Ensign_Ian_Hochstein,_assigned_to_the_frigate_USS_Ford_(FFG_54),_teaches_a_young_girl_to_spin_a_basketball_at_the_Ban_Kao_Chan_Primary_School_in_Sattahip.jpg); Model rocket: <http://www.flickr.com/photos/34022876@N06/3509029796/>; Baseball: <http://www.flickr.com/photos/msciba/210081711/> . Carousel: CC BY 2.0; Skydiver: Public Domain; Runner: CC BY 2.0; Basketball: Public Domain; Model rocket: CC BY 2.0; Baseball: CC BY 2.0
12. Neil Cain. <http://www.flickr.com/photos/pimpmasterjazz/2601898276/> . CC BY 2.0
13. Christopher Auyeung. [CK-12 Foundation](#) . CC BY-NC 3.0

CHAPTER 13

Forces

Chapter Outline

- 13.1 WHAT IS FORCE?
- 13.2 FRICTION
- 13.3 GRAVITY
- 13.4 ELASTIC FORCE
- 13.5 REFERENCES



Each of these basketball players is trying to push the ball. One player is trying to push it into the basket, and the other player is trying to push it away from the basket. If both players push the ball at the same time, where will it go? It depends on which player pushes the ball with greater force. Forces like this come into play in every sport, whether it's kicking a soccer ball, throwing a baseball, or spiking a volleyball. Forces are involved not only in sports such as these but in every motion in our daily lives. In this chapter, you'll see how forces affect the motion of everything from basketballs to planets.

Image copyright S.Pytel, 2013. www.shutterstock.com. Used under license from Shutterstock.com.

13.1 What Is Force?

Lesson Objectives

- Define force, and give examples of forces.
- Describe how forces combine and affect motion.

Lesson Vocabulary

- force
- net force
- newton (N)

Introduction

Any time the motion of an object changes, a force has been applied. Force can cause a stationary object to start moving or a moving object to accelerate. The moving object may change its speed, its direction, or both. How much an object's motion changes when a force is applied depends on the strength of the force and the object's mass. You can explore the how force, mass, and acceleration are related by doing the activity at the URL <http://www.harcourtschool.com/activity/newton/> . This will provide you with a good hands-on introduction to the concept of force in physics.

Defining Force

Force is defined as a push or a pull acting on an object. Examples of forces include friction and gravity. Both are covered in detail later in this chapter. Another example of force is applied force. It occurs when a person or thing applies force to an object, like the girl pushing the swing in **Figure 13.1**. The force of the push causes the swing to move.



FIGURE 13.1

When this girl pushes the swing away from her, it causes the swing to move in that direction.

Force as a Vector

Force is a vector because it has both size and direction. For example, the girl in **Figure 13.1** is pushing the swing away from herself. That's the direction of the force. She can give the swing a strong push or a weak push. That's the size, or strength, of the force. Like other vectors, forces can be represented with arrows. **Figure 13.2** shows some examples. The length of each arrow represents the strength of the force, and the way the arrow points represents the direction of the force. How could you use an arrow to represent the girl's push on the swing in **Figure 13.1**?

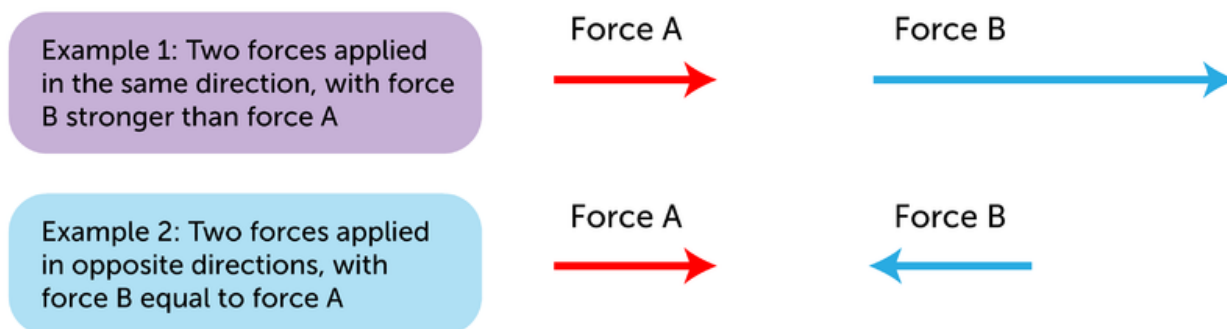

FIGURE 13.2

Forces can vary in both strength and direction.

SI Unit of Force

The SI unit of force is the newton (N). One newton is the amount of force that causes a mass of 1 kilogram to accelerate at 1 m/s^2 . Thus, the newton can also be expressed as $\text{kg}\cdot\text{m/s}^2$. The newton was named for the scientist Sir Isaac Newton, who is famous for his law of gravity. You'll learn more about Sir Isaac Newton later in the chapter.

Combining Forces

More than one force may act on an object at the same time. In fact, just about all objects on Earth have at least two forces acting on them at all times. One force is gravity, which pulls objects down toward the center of Earth. The other force is an upward force that may be provided by the ground or other surface.

Consider the example in **Figure 13.3**. A book is resting on a table. Gravity pulls the book downward with a force of 20 newtons. At the same time, the table pushes the book upward with a force of 20 newtons. The combined forces acting on the book—or any other object—are called the **net force**. This is the overall force acting on an object that takes into account all of the individual forces acting on the object. You can learn more about the concept of net force at this URL: <http://www.mansfieldct.org/schools/mms/staff/hand/lawsunbalancedforce.htm> .

Forces Acting in Opposite Directions

When two forces act on an object in opposite directions, like the book on the table, the net force is equal to the difference between the two forces. In other words, one force is subtracted from the other to calculate the net force.

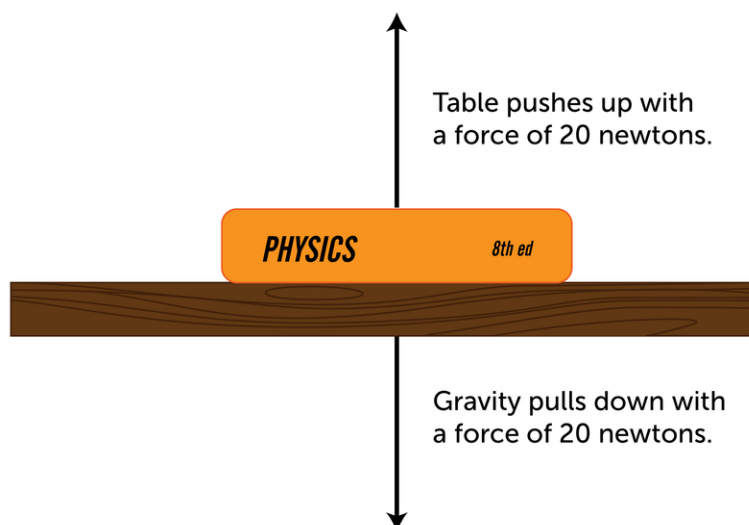

FIGURE 13.3

A book resting on a table is acted on by two opposing forces.

If the opposing forces are equal in strength, the net force is zero. That's what happens with the book on the table. The upward force minus the downward force equals zero ($20\text{ N up} - 20\text{ N down} = 0\text{ N}$). Because the forces on the book are balanced, the book remains on the table and doesn't move.

In addition to these downward and upward forces, which generally cancel each other out, forces may push or pull an object in other directions. Look at the dogs playing tug-of-war in **Figure 13.4**. One dog is pulling on the rope with a force of 10 newtons to the left. The other dog is pulling on the rope with a force of 12 newtons to the right. These opposing forces are not equal in strength, so they are unbalanced. When opposing forces are unbalanced, the net force is greater than zero. The net force on the rope is 2 newtons to the right, so the rope will move to the right.

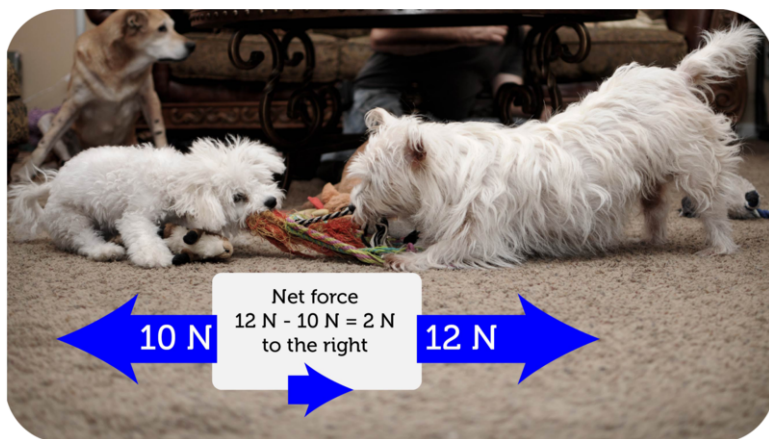

FIGURE 13.4

When unbalanced forces are applied to an object in opposite directions, the smaller force is subtracted from the larger force to yield the net force.

Forces Acting in the Same Direction

Two forces may act on an object in the same direction. You can see an example of this in **Figure 13.5**. After the man on the left lifts up the couch, he will push the couch to the right with a force of 25 newtons. At the same time, the man to the right is pulling the couch to the right with a force of 20 newtons. When two forces act in the same direction, the net force is equal to the sum of the forces. This always results in a stronger force than either of the

individual forces alone. In this case, the net force on the couch is 45 newtons to the right, so the couch will move to the right.

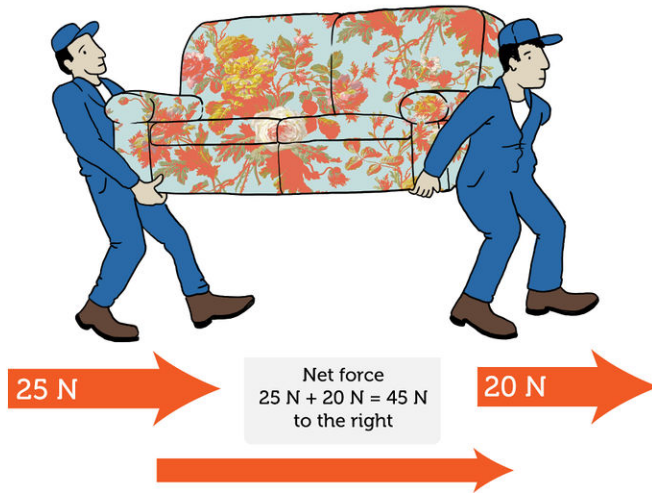
FIGURE 13.5

When two forces are applied to an object in the same direction, the two forces are added to yield the net force.

You Try It!

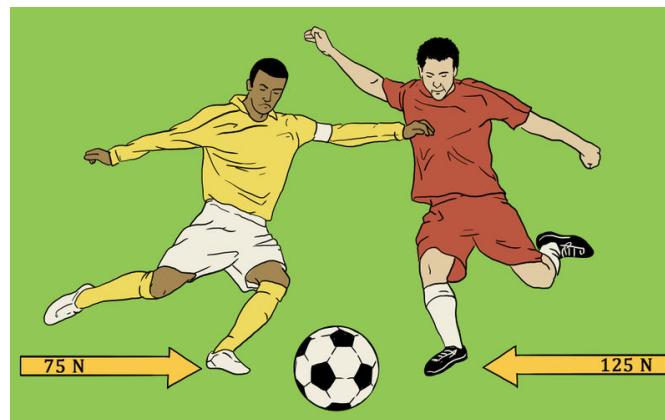

Problem: The boys in the drawing above are about to kick the soccer ball in opposite directions. What will be the net force on the ball? In which direction will the ball move?

If you need more practice calculating net force, go to this URL: <http://www.physicsclassroom.com/class/newtlaws/U2L2d.cfm> .

Lesson Summary

- Force is a push or a pull acting on an object. Examples of force include friction and gravity. Force is a vector because it has both size and direction. The SI unit of force is the newton (N).
- The combined forces acting on an object are called the net force. When forces act in opposite directions, they are subtracted to yield the net force. When they act in the same direction, they are added to yield the net force.

Lesson Review Questions

Recall

1. Define force. Give an example of a force.
2. What is a newton?
3. What is net force?
4. Describe an example of balanced forces and an example of unbalanced forces.

Apply Concepts

5. What is the net force acting on the block in each diagram below?

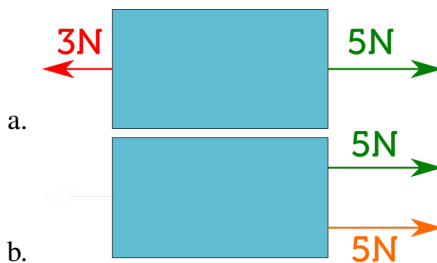

Think Critically

6. Explain how forces are related to motion.

Points to Consider

In the next lesson, "Friction," you will read about the force of friction. You experience this force every time you walk. It prevents your feet from slipping out from under you.

- How would you define friction?
- What do you think causes this force?

13.2 Friction

Lesson Objectives

- Describe friction and how it opposes motion.
 - Identify types of friction.
-

Lesson Vocabulary

- fluid
 - friction
-

Introduction

Did you ever rub your hands together to warm them up, like the girl in **Figure 13.6**? Why does this make your hands warmer? The answer is friction.



FIGURE 13.6

This girl is using friction to make her hands warmer.

What Is Friction?

Friction is a force that opposes motion between two surfaces that are touching. Friction can work for or against us. For example, putting sand on an icy sidewalk increases friction so you are less likely to slip. On the other hand,

too much friction between moving parts in a car engine can cause the parts to wear out. Other examples of friction are illustrated in **Figure 13.7**. You can see an animation showing how friction opposes motion at this URL: <http://www.darvill.clara.net/enforcemot/friction.htm> .

These photos show two ways that friction is useful:

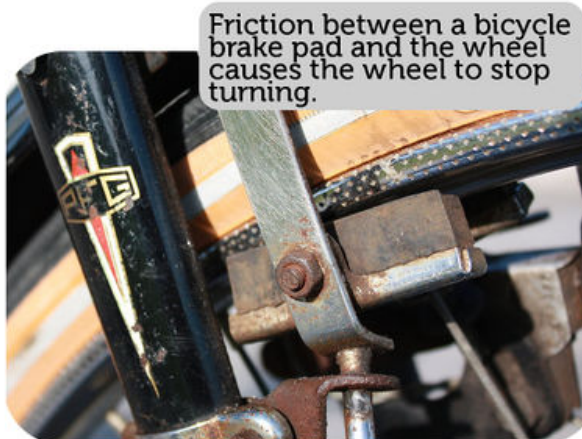
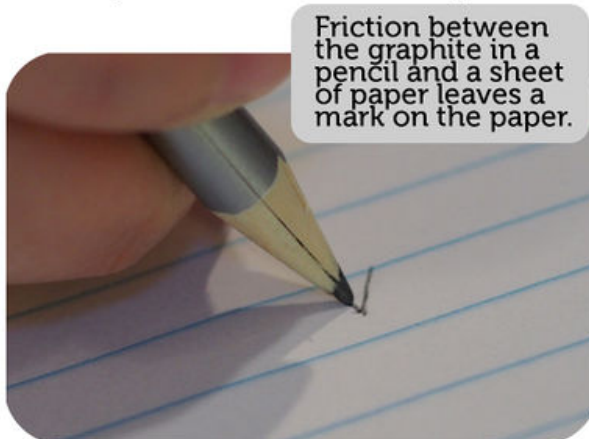

These photos show two ways that friction can cause problems:

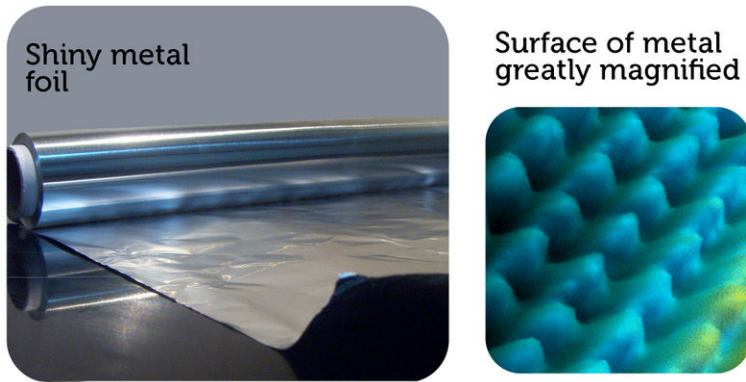

FIGURE 13.7

Sometimes friction is useful. Sometimes it's not.

Why Friction Occurs

Friction occurs because no surface is perfectly smooth. Even surfaces that look smooth to the unaided eye appear rough or bumpy when viewed under a microscope. Look at the metal surfaces in **Figure 13.8**. The metal foil is so smooth that it is shiny. However, when highly magnified, the surface of metal appears to be very bumpy. All those mountains and valleys catch and grab the mountains and valleys of any other surface that contacts the metal. This creates friction.

**FIGURE 13.8**

The surface of metal looks very smooth unless you look at it under a high-powered microscope.

Factors that Affect Friction

Rougher surfaces have more friction between them than smoother surfaces. That's why we put sand on icy sidewalks and roads. Increasing the area of surfaces that are touching also increases the friction between them. That's why you can't slide as far across ice with shoes as you can with skates (see **Figure 13.9**). The greater surface area of shoes causes more friction and slows you down. Heavier objects also have more friction because they press together with greater force. Did you ever try to push boxes or furniture across the floor? It's harder to overcome friction between heavier objects and the floor than it is between lighter objects and the floor.

**FIGURE 13.9**

The knife-like blades of speed skates minimize friction with the ice.

Friction Produces Heat

You know that friction produces heat. That's why rubbing your hands together makes them warmer. But do you know why the rubbing produces heat? Friction causes the molecules on rubbing surfaces to move faster, so they have more heat energy. Heat from friction can be useful. It not only warms your hands. It also lets you light a match (see **Figure 13.10**). On the other hand, heat from friction can be a problem inside a car engine. It can cause the car to overheat. To reduce friction, oil is added to the engine. Oil coats the surfaces of moving parts and makes them slippery so there is less friction.

**FIGURE 13.10**

When you rub the surface of a match head across the rough striking surface on the matchbox, the friction produces enough heat to ignite the match.

Types of Friction

There are different ways you could move heavy boxes. You could pick them up and carry them. You could slide them across the floor. Or you could put them on a dolly like the one in **Figure 13.11** and roll them across the floor. This example illustrates three types of friction: static friction, sliding friction, and rolling friction. Another type of friction is fluid friction. All four types of friction are described below. In each type, friction works opposite the direction of the force applied to a move an object. You can see a video demonstration of the different types of friction at this URL: <http://www.youtube.com/watch?v=0bXpYblzkR0> (1:07).

**FIGURE 13.11**

A dolly with wheels lets you easily roll boxes across the floor.

Static Friction

Static friction acts on objects when they are resting on a surface. For example, if you are walking on a sidewalk, there is static friction between your shoes and the concrete each time you put down your foot (see **Figure 13.12**). Without this static friction, your feet would slip out from under you, making it difficult to walk. Static friction also allows you to sit in a chair without sliding to the floor. Can you think of other examples of static friction?



FIGURE 13.12

Static friction between shoes and the sidewalk makes it possible to walk without slipping.

Sliding Friction

Sliding friction is friction that acts on objects when they are sliding over a surface. Sliding friction is weaker than static friction. That's why it's easier to slide a piece of furniture over the floor after you start it moving than it is to get it moving in the first place. Sliding friction can be useful. For example, you use sliding friction when you write with a pencil and when you put on your bike's brakes.

Rolling Friction

Rolling friction is friction that acts on objects when they are rolling over a surface. Rolling friction is much weaker than sliding friction or static friction. This explains why it is much easier to move boxes on a wheeled dolly than by carrying or sliding them. It also explains why most forms of ground transportation use wheels, including cars, 4-wheelers, bicycles, roller skates, and skateboards. Ball bearings are another use of rolling friction (see **Figure 13.13**). They allow parts of a wheel or other machine to roll rather than slide over one another.

Fluid Friction

Fluid friction is friction that acts on objects that are moving through a fluid. A **fluid** is a substance that can flow and take the shape of its container. Fluids include liquids and gases. If you've ever tried to push your open hand through the water in a tub or pool, then you've experienced fluid friction between your hand and the water. When a skydiver is falling toward Earth with a parachute, fluid friction between the parachute and the air slows the descent (see **Figure 13.14**). Fluid pressure with the air is called air resistance. The faster or larger a moving object is, the

Ball Bearings in a Wheel

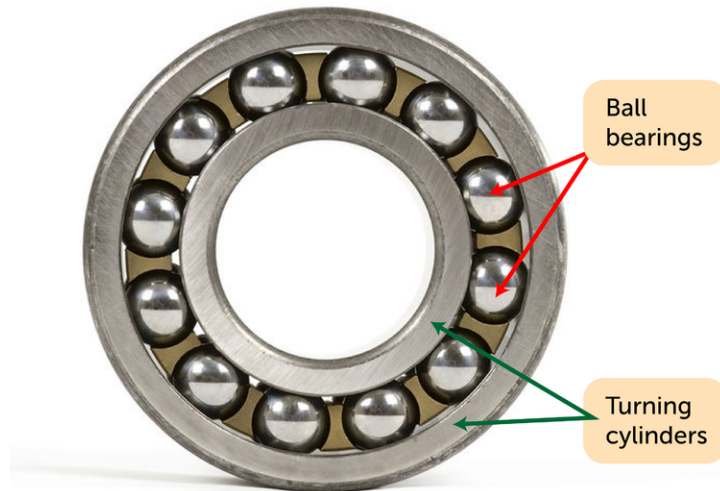
**FIGURE 13.13**

The ball bearings in this wheel reduce friction between the inner and outer cylinders when they turn.

greater is the fluid friction resisting its motion. The very large surface area of a parachute, for example, has greater air resistance than a skydiver's body.

Lesson Summary

- Friction is a force that opposes motion between two surfaces that are touching. Friction occurs because no surface is perfectly smooth. Friction is greater when objects have rougher surfaces, have more surface area that is touching, or are heavier so they press together with greater force.
- Types of friction include static friction, sliding friction, rolling friction, and fluid friction. Fluid friction with air is called air resistance.

Lesson Review Questions

Recall

1. What is friction?
2. List factors that affect friction.
3. How does friction produce heat?

Apply Concepts

4. Identify two forms of friction that oppose the motion of a moving car.

**FIGURE 13.14**

Fluid friction of the parachute with the air slows this skydiver as he falls.

Think Critically

5. Explain why friction occurs.
6. Compare and contrast the four types of friction described in this lesson.

Points to Consider

A skydiver like the one in **Figure 13.14** falls to the ground despite the fluid friction of his parachute with the air. Another force pulls him toward Earth. That force is gravity, which is the topic of the next lesson.

- What do you already know about gravity?
- What do you think causes gravity?

13.3 Gravity

Lesson Objectives

- Define gravity.
- State Newton's law of universal gravitation.
- Explain how gravity affects the motion of objects.

Lesson Vocabulary

- gravity
- law of universal gravitation
- orbit
- projectile motion

Introduction

Long, long ago, when the universe was still young, an incredible force caused dust and gas particles to pull together to form the objects in our solar system (see **Figure 13.15**). From the smallest moon to our enormous sun, this force created not only our solar system, but all the solar systems in all the galaxies of the universe. The force is gravity.

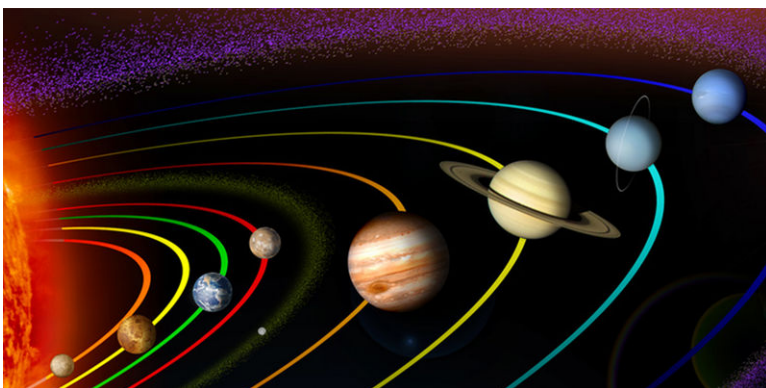

FIGURE 13.15

Gravity helped to form our solar system and all the other solar systems in the universe.

Defining Gravity

Gravity has traditionally been defined as a force of attraction between two masses. According to this conception of gravity, anything that has mass, no matter how small, exerts gravity on other matter. The effect of gravity is that objects exert a pull on other objects. Unlike friction, which acts only between objects that are touching, gravity also acts between objects that are not touching. In fact, gravity can act over very long distances.

Earth's Gravity

You are already very familiar with Earth's gravity. It constantly pulls you toward the center of the planet. It prevents you and everything else on Earth from being flung out into space as the planet spins on its axis. It also pulls objects above the surface, from meteors to skydivers, down to the ground. Gravity between Earth and the moon and between Earth and artificial satellites keeps all these objects circling around Earth. Gravity also keeps Earth moving around the sun.

Gravity and Weight

Weight measures the force of gravity pulling on an object. Because weight measures force, the SI unit for weight is the **newton (N)**. On Earth, a mass of 1 kilogram has a weight of about 10 newtons because of the pull of Earth's gravity. On the moon, which has less gravity, the same mass would weigh less. Weight is measured with a scale, like the spring scale in **Figure 13.16**. The scale measures the force with which gravity pulls an object downward.

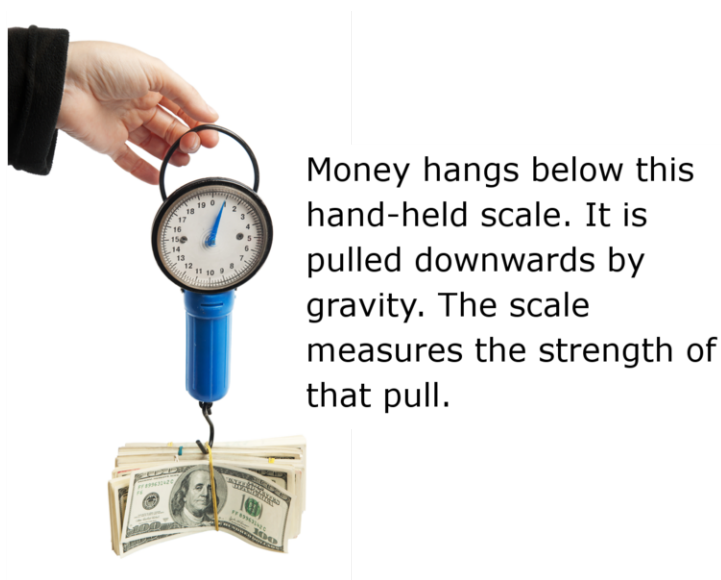

Money hangs below this hand-held scale. It is pulled downwards by gravity. The scale measures the strength of that pull.

FIGURE 13.16

A scale measures the pull of gravity on an object.

Law of Gravity

People have known about gravity for thousands of years. After all, they constantly experienced gravity in their daily lives. They knew that things always fall toward the ground. However, it wasn't until Sir Isaac Newton developed his law of gravity in the late 1600s that people really began to understand gravity. Newton is pictured in **Figure 13.17**.

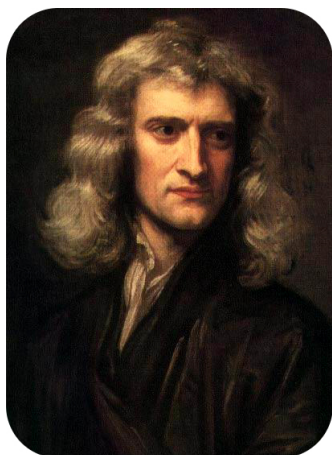
**FIGURE 13.17**

Sir Isaac Newton discovered that gravity is universal.

Newton's Law of Universal Gravitation

Newton was the first one to suggest that gravity is universal and affects all objects in the universe. That's why his law of gravity is called the **law of universal gravitation**. Universal gravitation means that the force that causes an apple to fall from a tree to the ground is the same force that causes the moon to keep moving around Earth. Universal gravitation also means that while Earth exerts a pull on you, you exert a pull on Earth. In fact, there is gravity between you and every mass around you —your desk, your book, your pen. Even tiny molecules of gas are attracted to one another by the force of gravity.

Newton's law had a huge impact on how people thought about the universe. It explains the motion of objects not only on Earth but in outer space as well. You can learn more about Newton's law of gravity in the video at this URL: <http://www.youtube.com/watch?v=O-p8yZYxNGc> .

Factors that Influence the Strength of Gravity

Newton's law also states that the strength of gravity between any two objects depends on two factors: the masses of the objects and the distance between them.

- Objects with greater mass have a stronger force of gravity. For example, because Earth is so massive, it attracts you and your desk more strongly than you and your desk attract each other. That's why you and the desk remain in place on the floor rather than moving toward one another.
- Objects that are closer together have a stronger force of gravity. For example, the moon is closer to Earth than it is to the more massive sun, so the force of gravity is greater between the moon and Earth than between the moon and the sun. That's why the moon circles around Earth rather than the sun. This is illustrated in **Figure 13.18**.

You can apply these relationships among mass, distance, and gravity by designing your own roller coaster at this URL: <http://www.learner.org/interactives/parkphysics/coaster/> .

Einstein's Theory of Gravity

Newton's idea of gravity can predict the motion of most but not all objects. In the early 1900s, Albert Einstein came up with a theory of gravity that is better at predicting how all objects move. Einstein showed mathematically that gravity is not really a force in the sense that Newton thought. Instead, gravity is a result of the warping, or curving,

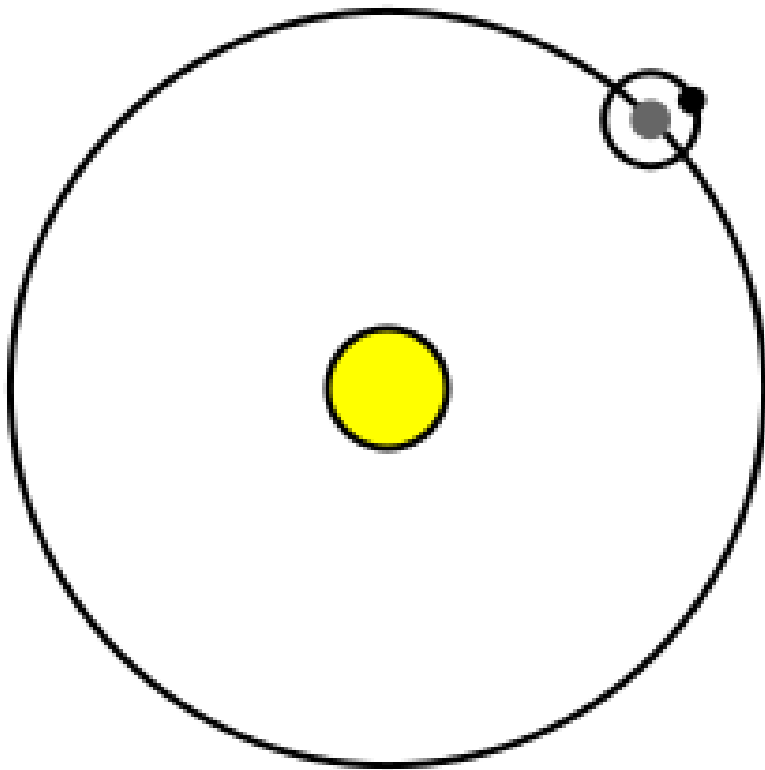
**FIGURE 13.18**

The moon keeps moving around Earth rather than the sun because it is much closer to Earth.

of space and time. Imagine a bowling ball pressing down on a trampoline. The surface of the trampoline would curve downward instead of being flat. Einstein theorized that Earth and other very massive bodies affect space and time around them in a similar way. This idea is represented in **Figure 13.19**. According to Einstein, objects curve toward one another because of the curves in space and time, not because they are pulling on each other with a force of attraction as Newton thought. You can see an animation of Einstein's theory of gravity at this URL: http://einstein.stanford.edu/Media/Einsteins_Universe_Anima-Flash.html . To learn about recent research that supports Einstein's theory of gravity, go to this URL: <http://www.universetoday.com/85401/gravity-probe-b-confirms-two-of-einsteins-space-time-theories/> .

Gravity and Motion

Regardless of what gravity is—a force between masses or the result of curves in space and time—the effects of gravity on motion are well known. You already know that gravity causes objects to fall down to the ground. Gravity affects the motion of objects in other ways as well.

Acceleration Due to Gravity

When gravity pulls objects toward the ground, it causes them to accelerate. Acceleration due to gravity equals 9.8 m/s^2 . In other words, the velocity at which an object falls toward Earth increases each second by 9.8 m/s . Therefore, after 1 second, an object is falling at a velocity of 9.8 m/s . After 2 seconds, it is falling at a velocity of 19.6 m/s ($9.8 \text{ m/s} \times 2$), and so on. This is illustrated in **Figure 13.20**. You can compare the acceleration due to gravity on Earth, the moon, and Mars with the interactive animation called "Freefall" at this URL: <http://jersey.uoregon.edu/vlab/> .

You might think that an object with greater mass would accelerate faster than an object with less mass. After all, its

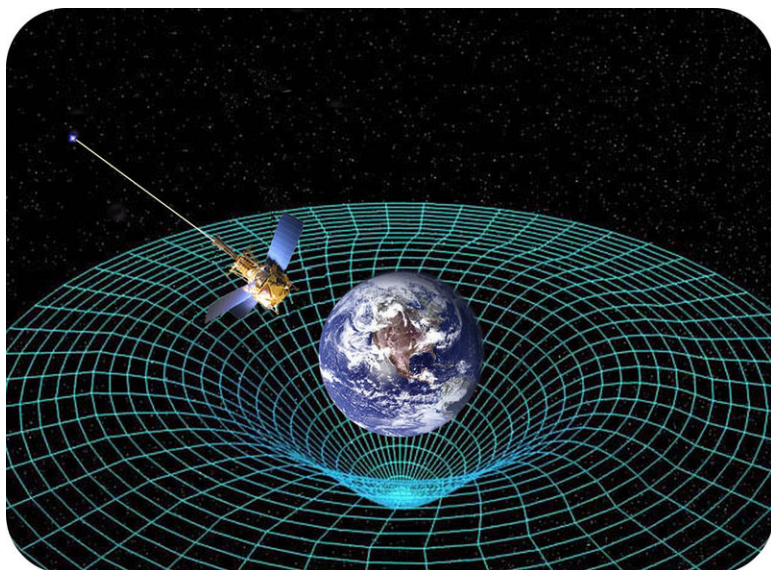

FIGURE 13.19

Einstein thought that gravity is the effect of curves in space and time around massive objects such as Earth. He proposed that the curves in space and time cause nearby objects to follow a curved path. How does this differ from Newton's idea of gravity?

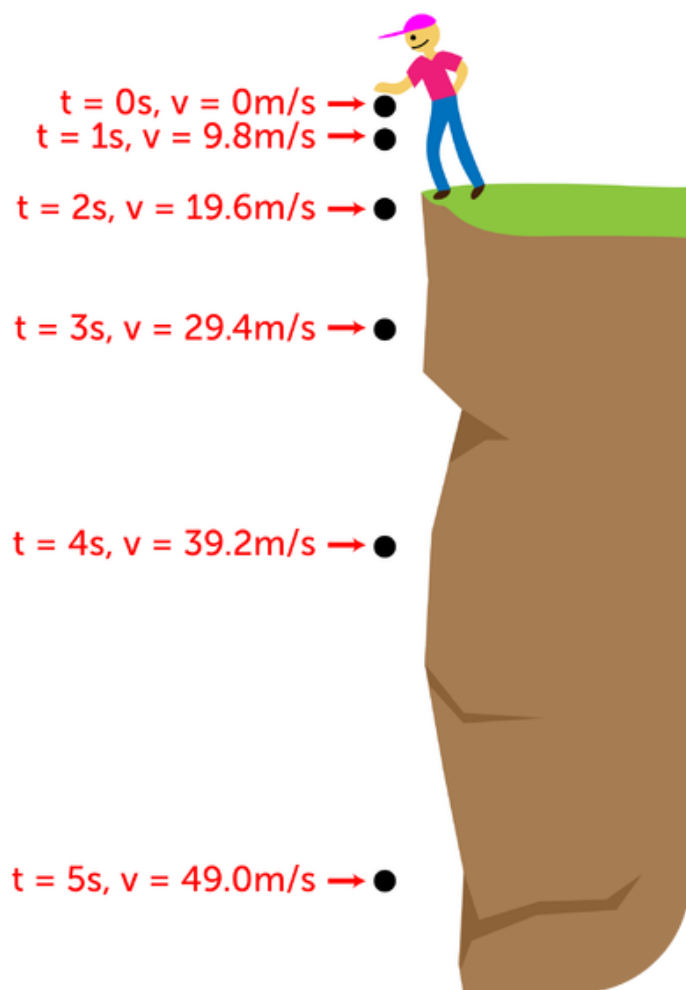

FIGURE 13.20

A boy drops an object at time $t = 0$ s. At time $t = 1$ s, the object is falling at a velocity of 9.8 m/s. What is its velocity by time $t = 5$?

greater mass means that it is pulled by a stronger force of gravity. However, a more massive object accelerates at the same rate as a less massive object. The reason? The more massive object is harder to move because of its greater mass. As a result, it ends up moving at the same acceleration as the less massive object.

Consider a bowling ball and a basketball. The bowling ball has greater mass than the basketball. However, if you were to drop both balls at the same time from the same distance above the ground, they would reach the ground together. This is true of all falling objects, unless air resistance affects one object more than another. For example, a falling leaf is slowed down by air resistance more than a falling acorn because of the leaf's greater surface area. However, if the leaf and acorn were to fall in the absence of air (that is, in a vacuum), they would reach the ground at the same time.

Projectile Motion

Earth's gravity also affects the acceleration of objects that start out moving horizontally, or parallel to the ground. Look at **Figure 13.21**. A cannon shoots a cannon ball straight ahead, giving the ball horizontal motion. At the same time, gravity pulls the ball down toward the ground. Both forces acting together cause the ball to move in a curved path. This is called **projectile motion**.

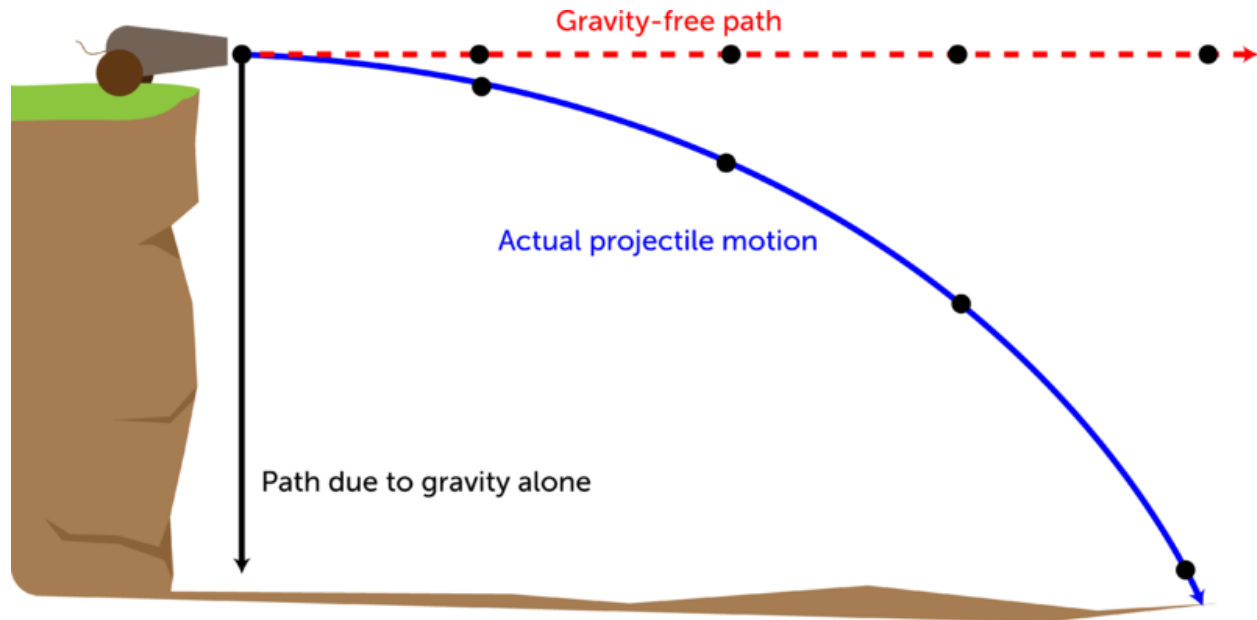

FIGURE 13.21

The cannon ball moves in a curved path because of the combined horizontal and downward forces.

Projectile motion also applies to other moving objects, such as arrows shot from a bow. To hit the bull's eye of a target with an arrow, you actually have to aim for a spot above the bull's eye. That's because by the time the arrow reaches the target, it has started to curve downward toward the ground. **Figure 13.22** shows what happens if you aim at the bull's eye instead of above it. You can access interactive animations of projectile motion at these URLs:

- <http://phet.colorado.edu/en/simulation/projectile-motion>
- <http://jersey.uoregon.edu/vlab/> (Select the applet entitled "Cannon.")

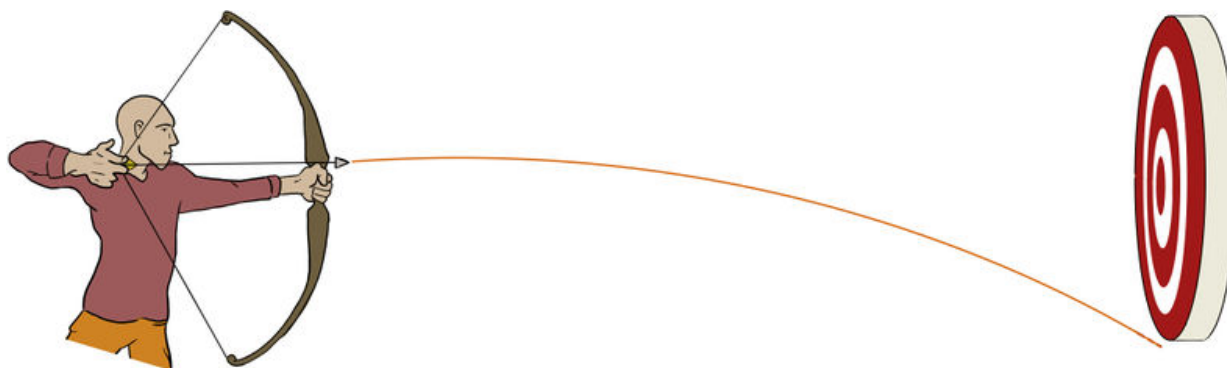

FIGURE 13.22

Aiming at the center of a target is likely to result in a hit below the bull's eye.

Orbital Motion

The moon moves around Earth in a circular path called an **orbit**. Why doesn't Earth's gravity pull the moon down to the ground instead? The moon has enough forward velocity to partly counter the force of Earth's gravity. It constantly falls toward Earth, but it stays far enough away from Earth so that it actually falls around the planet. As a result, the moon keeps orbiting Earth and never crashes into it. The diagram in **Figure 13.23** shows how this happens. You can explore gravity and orbital motion in depth with the animation at this URL: <http://phet.colorado.edu/en/simulation/gravity-and-orbits> .

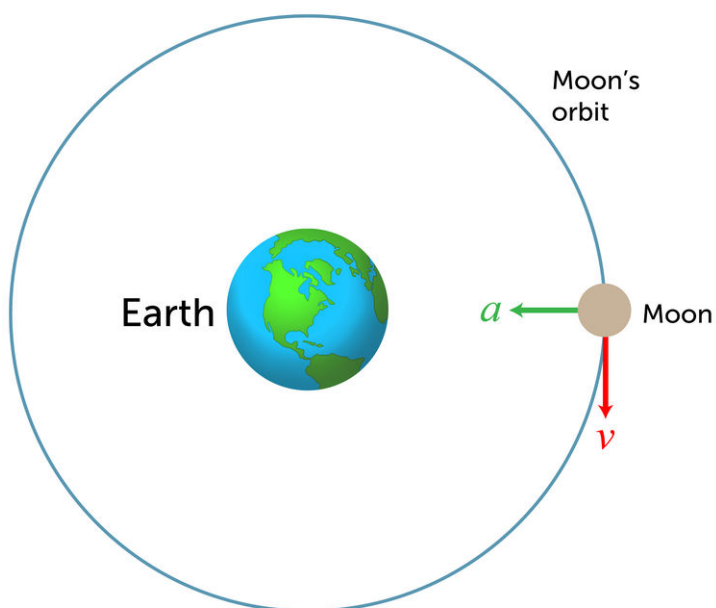

FIGURE 13.23

In this diagram, "v" represents the forward velocity of the moon, and "a" represents the acceleration due to gravity. The line encircling Earth shows the moon's actual orbit, which results from the combination of "v" and "a."

You can see an animated version of this diagram at: http://en.wikipedia.org/wiki/File:Orbital_motion.gif .

Lesson Summary

- Gravity is traditionally defined as a force of attraction between two masses. Weight measures the force of gravity and is expressed in newtons (N).
- According to Newton's law of universal gravitation, gravity is a force of attraction between all objects in the universe, and the strength of gravity depends on the masses of the objects and the distance between them. Einstein's theory of gravity states that gravity is an effect of curves in space and time around massive objects such as Earth.
- Gravity causes falling objects to accelerate at 9.8 m/s^2 . Gravity also causes projectile motion and orbital motion.

Lesson Review Questions

Recall

1. What is the traditional definition of gravity?
2. How is weight related to gravity?
3. Summarize Newton's law of universal gravitation.
4. Describe Einstein's idea of gravity.

Apply Concepts

5. Create a poster to illustrate the concept of projectile motion.

Think Critically

6. In the absence of air, why does an object with greater mass fall toward Earth at the same acceleration as an object with less mass?
7. Explain why the moon keeps orbiting Earth.

Points to Consider

The scale you saw in **Figure 13.16** contains a spring. When an object hangs from the scale, the spring exerts an upward force that partly counters the downward force of gravity. The type of force exerted by a spring is called elastic force, which is the topic of the next lesson.

- Besides springs, what other objects do you think might exert elastic force?
- What other ways might you use elastic force?

13.4 Elastic Force

Lesson Objectives

- Define elasticity and elastic force.
- Describe uses of elastic force.

Lesson Vocabulary

- elastic force
- elasticity

Introduction

The boy in **Figure 13.24** has a newspaper route. Every morning, he rolls up newspapers for his customers and puts rubber bands around them. The rubber bands keep the newspapers tightly rolled up so it is easy to toss them onto porches and driveways as the boy rides by on his bike. Rubber bands are useful for this purpose because they are elastic.

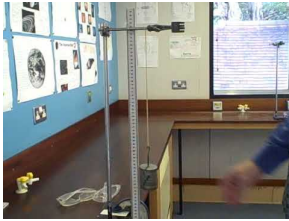

FIGURE 13.24

A stretchy rubber band holds this newspaper in a tight roll.

Elasticity and Elastic Force

Something that is elastic can return to its original shape after being stretched or compressed. This property is called **elasticity**. As you stretch or compress an elastic material, it resists the change in shape. It exerts a counter force in the opposite direction. This force is called **elastic force**. Elastic force causes the material to spring back to its original shape as soon as the stretching or compressing force is released. You can watch a demonstration of elastic force at this URL: <http://www.youtube.com/watch?v=fFtM9JznLh8> (3:57).



MEDIA

Click image to the left for more content.

Using Elastic Force

Elastic force can be very useful. You probably use it yourself every day. A few common uses of elastic force are pictured in **Figure 13.25**. Did you ever use a resistance band like the one in the figure? When you pull on the band, it stretches but doesn't break. The resistance you feel when you pull on it is elastic force. The resistance of the band to stretching is what gives your muscles a workout. After you stop pulling on the band, it returns to its original shape, ready for the next workout.

Springs like the ones in **Figure 13.26** also have elastic force when they are stretched or compressed. And like stretchy materials, they return to their original shape when the stretching or compressing force is released. Because of these properties, springs are used in scales to measure weight. They also cushion the ride in a car and provide springy support beneath a mattress. Can you think of other uses of springs?

Lesson Summary

- Elasticity is the ability of a material to return to its original shape after being stretched or compressed. Elastic force is the counter force that resists the stretching or compressing of an elastic material.
- Elastic force is very useful. It is used in rubber bands, bungee cords, and bed springs, to name just a few uses.

Lesson Review Questions

Recall

1. What is elasticity?
2. Describe elastic force.
3. Identify uses of elastic force.

**FIGURE 13.25**

All these items are useful because they can be stretched and then return to their original shape.

**FIGURE 13.26**

Springs are useful because they return to their original shape after being stretched or compressed.

Apply Concepts

- Think of a way you could demonstrate elastic force to a younger student. Describe the procedure you would follow and the materials you would use.

Think Critically

5. Explain how springs are used in scales to measure weight.

Points to Consider

In this chapter, you read about Newton's law of universal gravitation. Newton developed several other laws as well. In the next chapter, "Newton's Laws of Motion," you'll read about his three laws of motion. Recall what you already know about motion.

- What is motion? What are examples of motion?
- What causes changes in motion? What are changes in motion called?

13.5 References

1. Flickr:techlah. <http://www.flickr.com/photos/techlah/67146616/> . CC BY 2.0
2. Christopher Auyeung. [CK-12 Foundation](#) . CC BY-NC 3.0
3. Christopher Auyeung. [CK-12 Foundation](#) . CC BY-NC 3.0
4. Mathew Cerasoli, modified by CK-12 Foundation. <http://www.flickr.com/photos/mcerasoli/6484117955/> . CC BY 2.0
5. Laura Guerin. [CK-12 Foundation](#) . CC BY-NC 3.0
6. Image copyright Leah-Anne Thompson, 2013. <http://www.shutterstock.com> . Used under license from Shutterstock.com
7. Pencil: Joy Sheng; Brake pad: Jeremy Burgin; Slide: David Amsler (Flickr:amslerPIX); Scrape: Daniel Oines (Flickr:dno1967b). Pencil: [CK-12 Foundation](#); Brake pad: http://commons.wikimedia.org/wiki/File:Fongers_-_brake_pad.jpg; Slide: <http://www.flickr.com/photos/amslerpix/8131034392/>; Scrape: <http://www.flickr.com/photos/dno1967b/8600409871/> . Pencil: CC BY-NC 3.0; Brake pad, Slide, Scrape: CC BY 2.0
8. Foil: User:MdeVicente/Wikimedia Commons; Magnified surface: Courtesy of NIST. Foil: <http://commons.wikimedia.org/wiki/File:Aluminio.jpg>; Magnified surface: <http://www.nist.gov/pml/general/stm/index.cfm> . Public Domain
9. Vincent Baas. http://commons.wikimedia.org/wiki/File:Skate_shorttrack.jpg . CC BY 2.5
10. LASZLO ILYES (Flickr:laszlo-photo). www.flickr.com/photos/laszlo-photo/1752196179/ . CC BY 2.0
11. Image copyright trekandshoot, 2013. <http://www.shutterstock.com> . Used under license from Shutterstock.com
12. Beatrice Murch (Flickr:blmurch). <http://www.flickr.com/photos/blmurch/2196978992/> . CC BY 2.0
13. Image copyright Ramona Heim, 2013, modified by CK-12 Foundation. <http://www.shutterstock.com> . Used under license from Shutterstock.com
14. New Zealand Defence Force. <http://www.flickr.com/photos/nzdefenceforce/7458368740/> . CC BY 2.0
15. Flickr: Image Editor. <http://www.flickr.com/photos/11304375@N07/2818891443/> . CC BY 2.0
16. Handheld scale image copyright Dja65, 2013; modified by CK-12 Foundation. <http://www.shutterstock.com> . Used under license from Shutterstock.com
17. Sir Godfrey Kneller. <http://commons.wikimedia.org/wiki/File:GodfreyKneller-IsaacNewton-1689.jpg> . Public Domain
18. User:Tó campos/Wikipedia. http://commons.wikimedia.org/wiki/File:Sun_earth_moon.svg . Public Domain
19. Courtesy of NASA. http://commons.wikimedia.org/wiki/File:GPB_circling_earth.jpg . Public Domain
20. Christopher Auyeung. [CK-12 Foundation](#) . CC BY-NC 3.0
21. Christopher Auyeung. [CK-12 Foundation](#) . CC BY-NC 3.0
22. Laura Guerin. [CK-12 Foundation](#) . CC BY-NC 3.0
23. Christopher Auyeung and Laura Guerin. [CK-12 Foundation](#) . CC BY-NC 3.0
24. Laura Guerin. [CK-12 Foundation](#) . CC BY-NC 3.0
25. Hair scrunchies: Elisa Xyz; Elastic waistband: Maegan Tintari; Bungee cords: User:Jmb/Wikipedia; Resistance band: Photo by Dijon Nichelle Rolle, USAG Baden-Wuerttemberg. Hair scrunchies: <http://www.publicdomainpictures.net/view-image.php?image=3184&picture=color-scrunchies>; Elastic waistband: <http://www.flickr.com/photos/lovemaegan/3939126292/>; Bungee cords: http://commons.wikimedia.org/wiki/File:Bungee_Cord_PICT6882a.jpg; Resistance band: <http://www.flickr.com/photos/familymwr/5032496501/> . Hair scrunchies: Public Domain; Elastic waistband: CC BY 2.0; Bungee cords: CC BY 2.5; Resistance band: CC BY 2.0
26. User:Batholith/Jp.Wikipedia. http://commons.wikimedia.org/wiki/File:Compression_springs_20101109.jpg . Public Domain

CHAPTER

14

Newton's Laws of Motion

Chapter Outline

- 14.1 NEWTON'S FIRST LAW
- 14.2 NEWTON'S SECOND LAW
- 14.3 NEWTON'S THIRD LAW
- 14.4 REFERENCES



The sprinter in this photo is pushing off from the blocks at the start of a race. The blocks provide a counter force so she can take off in a hurry. With great effort, she will go from motionless to top speed in just a few seconds. She won't slow down until she crosses the finish line. By then, she will be going so fast that it will take her almost as much time to come to a full stop as it did to run the race.

No doubt you've experienced motions like these, even if you've never run a race. But do you know what explains these motions? For example, do you know why it's as hard to stop running as it is to start? These and other aspects of motion are explained by three laws of motion. The laws were developed by Sir Isaac Newton in the late 1600s. You'll learn about Newton's laws of motion in this chapter and how and why objects move as they do.

Flickr:tableatny. www.flickr.com/photos/53370644@N06/4976491750/. CC BY 2.0.

14.1 Newton's First Law

Lesson Objectives

- State Newton's first law of motion.
- Define inertia, and explain its relationship to mass.

Lesson Vocabulary

- inertia
- Newton's first law of motion

Introduction

The amusement park ride pictured in **Figure 14.1** keeps changing direction as it zooms back and forth. Each time it abruptly switches direction, the riders are forced to the opposite side of the car. What force causes this to happen? In this lesson, you'll find out.



FIGURE 14.1

Amusement park rides like this one are exciting because of the strong forces the riders feel.

Force and Motion

Newton's first law of motion states that an object's motion will not change unless an unbalanced force acts on the object. If the object is at rest, it will stay at rest. If the object is in motion, it will stay in motion and its velocity will remain the same. In other words, neither the direction nor the speed of the object will change as long as the net force acting on it is zero. You can watch a video about Newton's first law at this URL: <http://videos.howstuffworks.com/discovery/29382-assignment-discovery-newtons-first-law-video.htm> .

Look at the pool balls in **Figure 14.2**. When a pool player pushes the pool stick against the white ball, the white ball is set into motion. Once the white ball is rolling, it rolls all the way across the table and stops moving only after it crashes into the cluster of colored balls. Then, the force of the collision starts the colored balls moving. Some may roll until they bounce off the raised sides of the table. Some may fall down into the holes at the edges of the table. None of these motions will occur, however, unless that initial push of the pool stick is applied. As long as the net force on the balls is zero, they will remain at rest.



Force from the moving pool stick starts the white ball rolling. Force from the moving white ball sets the other balls into motion.



FIGURE 14.2

Pool balls remain at rest until an unbalanced force is applied to them. After they are in motion, they stay in motion until another force opposes their motion.

Inertia

Newton's first law of motion is also called the law of inertia. **Inertia** is the tendency of an object to resist a change in its motion. If an object is already at rest, inertia will keep it at rest. If the object is already moving, inertia will keep it moving.

Think about what happens when you are riding in a car that stops suddenly. Your body moves forward on the seat. Why? The brakes stop the car but not your body, so your body keeps moving forward because of inertia. That's why it's important to always wear a seat belt. Inertia also explains the amusement park ride in **Figure 14.1**. The car

keeps changing direction, but the riders keep moving in the same direction as before. They slide to the opposite side of the car as a result. You can see an animation of inertia at this URL: <http://www.physicsclassroom.com/mmedia/newtlaws/cci.cfm> .

Inertia and Mass

The inertia of an object depends on its mass. Objects with greater mass also have greater inertia. Think how hard it would be to push a big box full of books, like the one in **Figure 14.3**. Then think how easy it would be to push the box if it was empty. The full box is harder to move because it has greater mass and therefore greater inertia.



FIGURE 14.3

The tendency of an object to resist a change in its motion depends on its mass. Which box has greater inertia?

Overcoming Inertia

To change the motion of an object, inertia must be overcome by an unbalanced force acting on the object. Until the soccer player kicks the ball in **Figure 14.4**, the ball remains motionless on the ground. However, when the ball is kicked, the force on it is suddenly unbalanced. The ball starts moving across the field because its inertia has been overcome.



FIGURE 14.4

Force must be applied to overcome the inertia of a soccer ball at rest.

Once objects start moving, inertia keeps them moving without any additional force being applied. In fact, they won't stop moving unless another unbalanced force opposes their motion. What if the rolling soccer ball is not kicked by another player or stopped by a fence or other object? Will it just keep rolling forever? It would if another unbalanced force did not oppose its motion. Friction—in this case rolling friction with the ground—will oppose the motion of the rolling soccer ball. As a result, the ball will eventually come to rest. Friction opposes the motion of all moving objects, so, like the soccer ball, all moving objects eventually come to a stop even if no other forces oppose their motion.

Lesson Summary

- Newton's first law of motion states that an object's motion will not change unless an unbalanced force acts on the object. If the object is at rest, it will stay at rest. If the object is in motion, it will stay in motion.
- Inertia is the tendency of an object to resist a change in its motion. The inertia of an object depends on its mass. Objects with greater mass have greater inertia. To overcome inertia, an unbalanced force must be applied to an object.

Lesson Review Questions

Recall

1. State Newton's first law of motion.
2. Define inertia.
3. How does an object's mass affect its inertia?

Apply Concepts

4. Assume you are riding a skateboard and you run into a curb. Your skateboard suddenly stops its forward motion. Apply the concept of inertia to this scenario, and explain what happens next.

Think Critically

5. Why is Newton's first law of motion also called the law of inertia?

Points to Consider

In this lesson, you read that the mass of an object determines its inertia. You also learned that an unbalanced force must be applied to an object to overcome its inertia, whether it is moving or at rest. An unbalanced force causes an object to accelerate.

- Predict how the mass of an object affects its acceleration when an unbalanced force is applied to it.
- How do you think the acceleration of an object is related to the strength of the unbalanced force acting on it?

14.2 Newton's Second Law

Lesson Objectives

- State Newton's second law of motion.
- Identify the relationship between acceleration and weight.

Lesson Vocabulary

- Newton's second law of motion

Introduction

A car's gas pedal, like the one in **Figure 14.5**, is sometimes called the accelerator. That's because it controls the acceleration of the car. Pressing down on the gas pedal gives the car more gas and causes the car to speed up. Letting up on the gas pedal gives the car less gas and causes the car to slow down. Whenever an object speeds up, slows down, or changes direction, it accelerates. Acceleration is a measure of the change in velocity of a moving object. Acceleration occurs whenever an object is acted upon by an unbalanced force.



FIGURE 14.5

The car pedal on the right controls the amount of gas the engine gets. How does this affect the car's acceleration?

Acceleration, Force, and Mass

Newton determined that two factors affect the acceleration of an object: the net force acting on the object and the object's mass. The relationships between these two factors and motion make up **Newton's second law of motion**. This law states that the acceleration of an object equals the net force acting on the object divided by the object's mass. This can be represented by the equation:

$$\text{Acceleration} = \frac{\text{Net force}}{\text{Mass}}, \text{ or}$$

$$a = \frac{F}{m}$$

You can watch a video about how Newton's second law of motion applies to football at this URL: <http://science360.gov/obj/video/58e62534-e38d-430b-bfb1-c505e628a2d4> .

Direct and Inverse Relationships

Newton's second law shows that there is a direct relationship between force and acceleration. The greater the force that is applied to an object of a given mass, the more the object will accelerate. For example, doubling the force on the object doubles its acceleration. The relationship between mass and acceleration, on the other hand, is an inverse relationship. The greater the mass of an object, the less it will accelerate when a given force is applied. For example, doubling the mass of an object results in only half as much acceleration for the same amount of force.

Consider the example of a batter, like the boy in **Figure 14.6**. The harder he hits the ball, the greater will be its acceleration. It will travel faster and farther if he hits it with more force. What if the batter hits a baseball and a softball with the same amount of force? The softball will accelerate less than the baseball because the softball has greater mass. As a result, it won't travel as fast or as far as the baseball.



FIGURE 14.6

Hitting a baseball with greater force gives it greater acceleration. Hitting a softball with the same amount of force results in less acceleration. Can you explain why?

Calculating Acceleration

The equation for acceleration given above can be used to calculate the acceleration of an object that is acted on by an unbalanced force. For example, assume you are pushing a large wooden trunk, like the one shown in **Figure 14.7**. The trunk has a mass of 10 kilograms, and you are pushing it with a force of 20 newtons. To calculate the acceleration of the trunk, substitute these values in the equation for acceleration:

$$a = \frac{F}{m} = \frac{20 \text{ N}}{10 \text{ kg}} = \frac{2 \text{ N}}{\text{kg}}$$

Recall that one newton (1 N) is the force needed to cause a 1-kilogram mass to accelerate at 1 m/s^2 . Therefore, force can also be expressed in the unit $\text{kg}\cdot\text{m/s}^2$. This way of expressing force can be substituted for newtons in the solution to the problem:

$$a = \frac{2 \text{ N}}{\text{kg}} = \frac{2 \text{ kg}\cdot\text{m/s}^2}{\text{kg}} = 2 \text{ m/s}^2$$

Why are there no kilograms in the final answer to this problem? The kilogram units in the numerator and denominator of the fraction cancel out. As a result, the answer is expressed in the correct units for acceleration: m/s^2 .

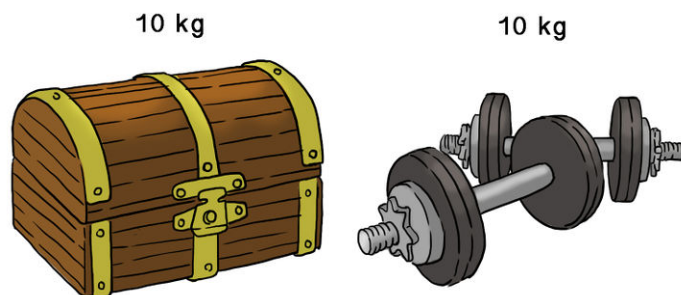
FIGURE 14.7

This empty trunk has a mass of 10 kilograms. The weights also have a mass of 10 kilograms. If the weights are placed in the trunk, what will be its mass? How will this affect its acceleration?

You Try It!

Problem: Assume that you add the weights to the trunk in **Figure 14.7**. If you push the trunk and weights with a force of 20 N, what will be the trunk's acceleration?

Need more practice? You can find additional problems at this URL: <http://www.auburnschools.org/ajhs/lmcrowe/Week%2014/WorksheetPracticeProblemsforNewtons2law.pdf> .

Acceleration and Weight

Newton's second law of motion explains the weight of objects. Weight is a measure of the force of gravity pulling on an object of a given mass. It's the force (F) in the acceleration equation that was introduced above:

$$a = \frac{F}{m}$$

This equation can also be written as:

$$F = m \times a$$

The acceleration due to gravity of an object equals 9.8 m/s^2 , so if you know the mass of an object, you can calculate its weight as:

$$F = m \times 9.8 \text{ m/s}^2$$

As this equation shows, weight is directly related to mass. As an object's mass increases, so does its weight. For example, if mass doubles, weight doubles as well. You can learn more about weight and acceleration at this URL: http://www.nasa.gov/mov/192448main_018_force_equals_mass_time.mov .

Problem Solving

Problem: Daisy has a mass of 35 kilograms. How much does she weigh?

Solution: Use the formula: $F = m \times 9.8 \text{ m/s}^2$.

$$F = 35 \text{ kg} \times 9.8 \text{ m/s}^2 = 343.0 \text{ kg} \cdot \text{m/s}^2 = 343.0 \text{ N}$$

You Try It!

Problem: Daisy's dad has a mass is 70 kg, which is twice Daisy's mass. Predict how much Daisy's dad weighs. Then calculate his weight to see if your prediction is correct.

Helpful Hints

The equation for calculating weight ($F = m \times a$) works only when the correct units of measurement are used.

- Mass must be in kilograms (kg).
- Acceleration must be in m/s^2 .
- Weight (F) is expressed in $\text{kg} \cdot \text{m/s}^2$ or in newtons (N).

Lesson Summary

- Newton's second law of motion states that the acceleration of an object equals the net force acting on the object divided by the object's mass.
- Weight is a measure of the force of gravity pulling on an object of a given mass. It equals the mass of the object (in kilograms) times the acceleration due to gravity (9.8 m/s^2).

Lesson Review Questions

Recall

1. State Newton's second law of motion.
2. Describe how the net force acting on an object is related to its acceleration.
3. If the mass of an object increases, how is its acceleration affected, assuming the net force acting on the object remains the same?
4. What is weight?

Apply Concepts

5. Tori applies a force of 20 newtons to move a bookcase with a mass of 40 kg. What is the acceleration of the bookcase?
6. Ollie has a mass of 45 kilograms. What is his weight in newtons?

Think Critically

7. If you know your weight in newtons, how could you calculate your mass in kilograms? What formula would you use?

Points to Consider

Assume that a 5-kilogram skateboard and a 50-kilogram go-cart start rolling down a hill. Both are moving at the same speed. You and a friend want to stop before they plunge into a pond at the bottom of the hill.

- Which will be harder to stop: the skateboard or the go-cart?
- Can you explain why?

14.3 Newton's Third Law

Lesson Objectives

- State Newton's third law of motion.
- Describe momentum and the conservation of momentum.

Lesson Vocabulary

- law of conservation of momentum
- momentum
- Newton's third law of motion

Introduction

Look at the skateboarders in **Figure 14.8**. When they push against each other, it causes them to move apart. The harder they push together, the farther apart they move. This is an example of Newton's third law of motion.

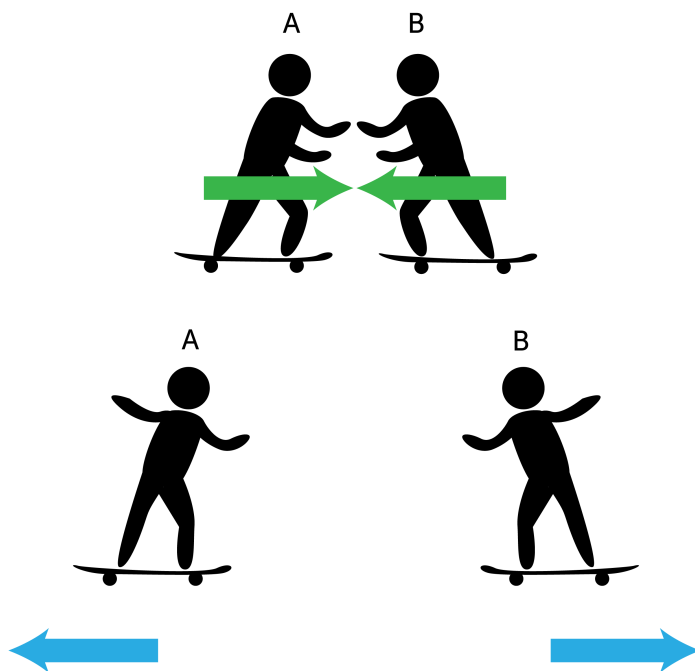

FIGURE 14.8

A and B move apart by first pushing together.

Action and Reaction

Newton's third law of motion states that every action has an equal and opposite reaction. This means that forces always act in pairs. First an action occurs, such as the skateboarders pushing together. Then a reaction occurs that is equal in strength to the action but in the opposite direction. In the case of the skateboarders, they move apart, and the distance they move depends on how hard they first pushed together. You can see other examples of actions and reactions in **Figure 14.9**. You can watch a video about actions and reactions at this URL: http://www.nasa.gov/mov/192449main_019_law_of_action.mov .



FIGURE 14.9

Each example shown here includes an action and reaction.

You might think that actions and reactions would cancel each other out like balanced forces do. Balanced forces, which are also equal and opposite, cancel each other out because they act on the same object. Action and reaction forces, in contrast, act on different objects, so they don't cancel each other out and, in fact, often result in motion. For example, in **Figure 14.9**, the kangaroo's action acts on the ground, but the ground's reaction acts on the kangaroo. As a result, the kangaroo jumps away from the ground. One of the action-reaction examples in the **Figure 14.9** does not result in motion. Do you know which one it is?

Momentum

What if a friend asked you to play catch with a bowling ball, like the one pictured in **Figure 14.10**? Hopefully, you would refuse to play! A bowling ball would be too heavy to catch without risk of injury —assuming you could even throw it. That's because a bowling ball has a lot of mass. This gives it a great deal of momentum. **Momentum** is a property of a moving object that makes the object hard to stop. It equals the object's mass times its velocity. It can be represented by the equation:

$$\text{Momentum} = \text{Mass} \times \text{Velocity}$$

This equation shows that momentum is directly related to both mass and velocity. An object has greater momentum if it has greater mass, greater velocity, or both. For example, a bowling ball has greater momentum than a softball when both are moving at the same velocity because the bowling ball has greater mass. However, a softball moving at a very high velocity—say, 100 miles an hour—would have greater momentum than a slow-rolling bowling ball. If an object isn't moving at all, it has no momentum. That's because its velocity is zero, and zero times anything is zero.

FIGURE 14.10

A bowling ball and a softball differ in mass. How does this affect their momentum?

Calculating Momentum

Momentum can be calculated by multiplying an object's mass in kilograms (kg) by its velocity in meters per second (m/s). For example, assume that a golf ball has a mass of 0.05 kg. If the ball is traveling at a velocity of 50 m/s, its momentum is:

$$\text{Momentum} = 0.05 \text{ kg} \times 50 \text{ m/s} = 2.5 \text{ kg} \cdot \text{m/s}$$

Note that the SI unit for momentum is kg·m/s.

Problem Solving

Problem: What is the momentum of a 40-kg child who is running straight ahead with a velocity of 2 m/s?

Solution: The child has momentum of: $40 \text{ kg} \times 2 \text{ m/s} = 80 \text{ kg} \cdot \text{m/s}$.

You Try It!

Problem: Which football player has greater momentum?

Player A: mass = 60 kg; velocity = 2.5 m/s

Player B: mass = 65 kg; velocity = 2.0 m/s

Conservation of Momentum

When an action and reaction occur, momentum is transferred from one object to the other. However, the combined momentum of the objects remains the same. In other words, momentum is conserved. This is the **law of conservation of momentum**.

Consider the example of a truck colliding with a car, which is illustrated in **Figure 14.11**. Both vehicles are moving in the same direction before and after the collision, but the truck is moving faster than the car before the collision occurs. During the collision, the truck transfers some of its momentum to the car. After the collision, the truck is moving slower and the car is moving faster than before the collision occurred. Nonetheless, their combined momentum is the same both before and after the collision. You can see an animation showing how momentum is conserved in a head-on collision at this URL: <http://www.physicsclassroom.com/mmedia/momentum/cthoi.cfm> .

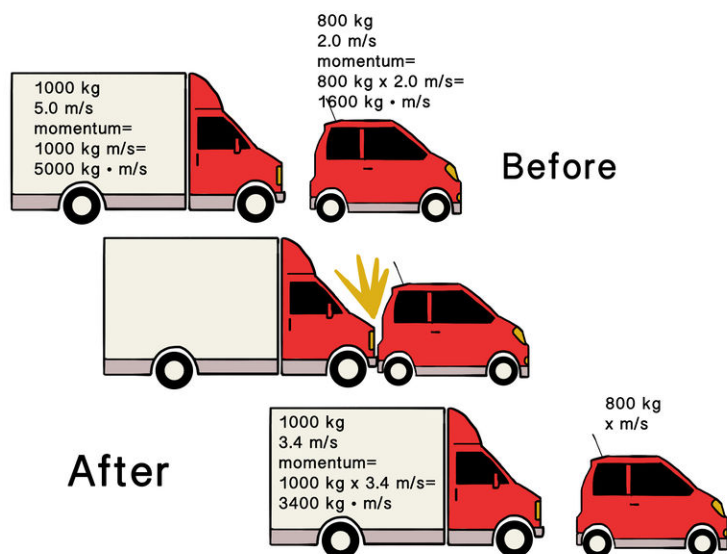

FIGURE 14.11

How can you tell momentum has been conserved in this collision?

Lesson Summary

- Newton's third law of motion states that every action has an equal and opposite reaction.
- Momentum is a property of a moving object that makes it hard to stop. It equals the object's mass times its velocity. When an action and reaction occur, momentum may be transferred from one object to another, but their combined momentum remains the same. This is the law of conservation of momentum.

Lesson Review Questions

Recall

1. State Newton's third law of motion.
2. Define momentum.

3. If you double the velocity of a moving object, how is its momentum affected?

Apply Concepts

4. A large rock has a mass of 50 kg and is rolling downhill at 3 m/s. What is its momentum?
5. Create a diagram to illustrate the transfer and conservation of momentum when a moving object collides with a stationary object.

Think Critically

6. The reaction to an action is an equal and opposite force. Why doesn't this yield a net force of zero?
7. Momentum is a property of an object, but it is different than a physical or chemical property, such as boiling point or flammability. How is momentum different?

Points to Consider

In this chapter, you learned about forces and motions of solid objects, such as balls and cars. In the next chapter, "Fluid Forces," you will learn about forces in fluids, which include liquids and gases.

- How do fluids differ from solids?
- What might be examples of forces in fluids? For example, what force allows some objects to float in water?

14.4 References

1. Image copyright Juriah Mosin, 2013. <http://www.shutterstock.com> . Used under license from Shutterstock.com
2. Top image copyright oorka, 2013; bottom image copyright attila, 2013. <http://www.shutterstock.com> . Used under licenses from Shutterstock.com
3. Laura Guerin. [CK-12 Foundation](#) . CC BY-NC 3.0
4. Bob Mical (Flickr:Small_Realm). http://www.flickr.com/photos/small_realm/6973964105/ . CC BY 2.0
5. Ray Sawhill. <http://www.flickr.com/photos/raysawhill/8306059830/> . CC BY 2.0
6. Flickr:Ron B. <http://www.flickr.com/photos/clamcake/4528602078/> . CC BY 2.0
7. Laura Guerin. [CK-12 Foundation](#) . CC BY-NC 3.0
8. Christopher Auyeung. [CK-12 Foundation](#) . CC BY-NC 3.0
9. Kangaroo: Chris Samuel; Kayaker: Mike Baird; Break dancer: angelo (Flickr:yapsnaps); Space shuttle: Courtesy of NASA. Kangaroo: <http://www.flickr.com/photos/chrissamuel/5366854530/>; Kayaker: <http://www.flickr.com/photos/mikebaird/6201271669/>; Break dancer: <http://www.flickr.com/photos/maladjusted/130569375/>; Space shuttle: http://commons.wikimedia.org/wiki/File:Space_Shuttle_Columbia_launching.jpg . Kangaroo, Kayaker, Break dancer: CC BY 2.0; Space shuttle: Public Domain
10. Bowling ball: Casey Fleaser (Flickr:somegeekintn); Softball: KT King. Bowling ball: <http://www.flickr.com/photos/somegeekintn/3899126494/>; Softball: <http://www.flickr.com/photos/xtrah/5660012808/> . CC BY 2.0
11. Laura Guerin. [CK-12 Foundation](#) . CC BY-NC 3.0

CHAPTER 15

Fluid Forces

Chapter Outline

- 15.1 PRESSURE OF FLUIDS
- 15.2 BUOYANCY OF FLUIDS
- 15.3 REFERENCES



This massive supertanker is one of the biggest ships ever to sail the ocean. Filled to capacity with oil, it weighs more than half a million metric tonnes. That's well over a billion pounds! How can such a tremendous weight float on water? Why doesn't it sink to the bottom of the ocean instead? In this chapter you'll find out.

Dan Tremper and the U.S. Coast Guard. commons.wikimedia.org/wiki/File:Hellespont_Alhambra-223713_v2.jpg. Public Domain.

15.1 Pressure of Fluids

Lesson Objectives

- Describe pressure and how to calculate it.
- Relate fluid depth and density to pressure.
- State Pascal's and Bernoulli's laws.

Lesson Vocabulary

- Bernoulli's law
- pascal (Pa)
- Pascal's law

Introduction

Did you ever use a bicycle pump like the one in **Figure 15.1**? The pump forces air into a tire through a small hole. Like other fluids (both liquids and gases), air can flow and take the shape of its container. The air that enters the tire from the pump quickly spreads out to fill the entire tire evenly. As the tire fills with air, it feels firmer. That's because the air exerts pressure against the inside surface of the tire.

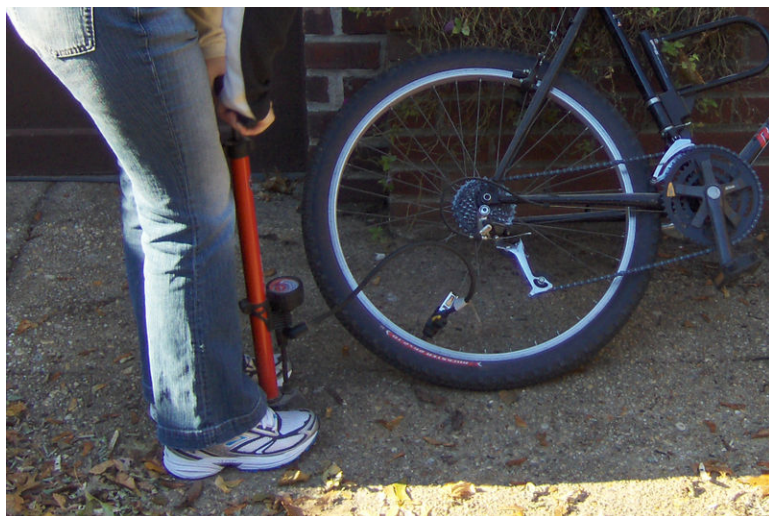

FIGURE 15.1

You can use a bicycle pump to force air into a tire.

What Is Pressure?

All fluids exert pressure like the air inside a tire. The particles of fluids are constantly moving in all directions at random. As the particles move, they keep bumping into each other and into anything else in their path. These collisions cause pressure, and the pressure is exerted equally in all directions. When particles are crowded together in one part of their container, they quickly spread out to fill their container. They always move from an area of higher pressure to an area of lower pressure. That's why air entering a tire quickly spreads throughout the tire.

Pressure, Force, and Area

Pressure is the result of force acting on a given area. It can be represented by the equation:

$$\text{Pressure} = \frac{\text{Force}}{\text{Area}}$$

Pressure shows how concentrated the force is on a given area. The smaller the area to which force is applied, the greater the pressure is. Think about pressing a pushpin, like the one in **Figure 15.2**, into a bulletin board. You apply force with your thumb to the broad head of the pushpin. However, the force that the pushpin applies to the bulletin board acts only over the tiny point of the pin. This is a much smaller area, so the pressure the point applies to the bulletin board is much greater than the pressure you apply with your thumb. As a result, the pin penetrates the bulletin board with ease.



FIGURE 15.2

A pushpin concentrates the force you apply to it. Can you explain how?

SI Unit for Pressure

In the equation for pressure, force is expressed in newtons (N) and area is expressed in square meters (m²). Therefore, pressure is expressed in N/m², which is the SI unit for pressure. This unit is also called the **pascal (Pa)**. It is named for the scientist Blaise Pascal, whose discovery about pressure in fluids is described later in this lesson. Pressure may also be expressed in the kilopascal (kPa), which equals 1000 pascals. For example, the correct air pressure inside a mountain bike tire is usually about 200 kPa.

Calculating Pressure or Force

When you know how much force is acting on a given area, you can calculate the pressure that is being applied to the area using the equation for pressure given above. For example, assume that a big rock weighs 500 newtons and is resting on the ground on an area of 0.5 m². The pressure exerted on the ground by the rock is:

$$\text{Pressure} = \frac{500 \text{ N}}{0.5 \text{ m}^2} = 1000 \text{ N/m}^2 = 1000 \text{ Pa, or } 1 \text{ kPa}$$

Sometimes pressure but not force is known. To calculate force, the equation for pressure can be rewritten as:

$$\text{Force} = \text{Pressure} \times \text{Area}$$

For example, suppose another rock exerts 2 kPa of pressure over an area of 0.3 m². How much does the rock weigh? Change 2 kPa to 2000 N/m² and substitute it for pressure in the force equation:

$$\text{Force (Weight)} = 2000 \text{ N/m}^2 \times 0.3 \text{ m}^2 = 600 \text{ N}$$

Problem Solving

Problem: A break dancer has a weight of 450 N. She is balancing on the ground on one hand. The palm of her hand has an area of 0.02 m². How much pressure does her hand exert on the ground?

Solution: Use the equation $\text{Pressure} = \frac{\text{Force}}{\text{Area}}$.

$$\text{Pressure} = \frac{450 \text{ N}}{0.02 \text{ m}^2} = 22500 \text{ Pa, or } 22.5 \text{ kPa}$$

You Try It!

Problem: If the break dancer lies down on the ground on her back, her weight is spread over an area of 0.75 m². How much pressure does she exert on the ground in this position?

Pressure in the Ocean and the Atmosphere

Both the water in the ocean and the air in the atmosphere exert pressure because of their moving particles. The ocean and atmosphere also illustrate two factors that affect pressure in fluids: depth and density.

- A fluid exerts more pressure at greater depths. Deeper in a fluid, all of the fluid above results in more weight pressing down. This causes greater pressure.
- Denser fluids such as water exert more pressure than less dense fluids such as air. The particles of denser fluids are closer together, so there are more collisions in a given area. This is illustrated in **Figure 15.3** for water and air.

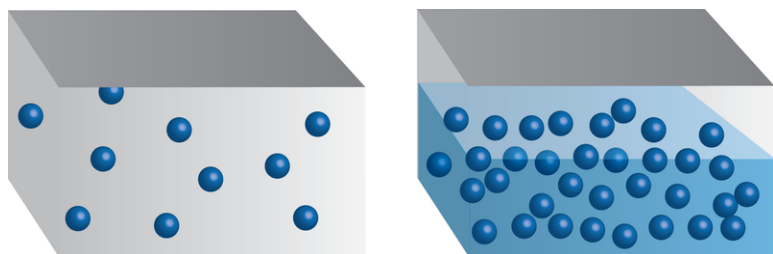

FIGURE 15.3

Differences in density between water and air lead to differences in pressure.

Water Pressure

As you go deeper in the ocean, the pressure exerted by the water increases steadily. The diagram in **Figure 15.4** shows how pressure changes with depth. For every additional meter below the surface, pressure increases by 10 kPa. At 30 meters below the surface, the pressure is double the pressure at the surface. At a depth greater than 500 meters, the pressure is too great for humans to withstand without special equipment to protect them. Around 9000 meters below the surface, in the deepest part of the ocean, the pressure is tremendous. You can see a video demonstration of changes in water pressure with depth at this URL: <http://www.youtube.com/watch?v=dL08xX4IBQg> (0:42).



MEDIA

Click image to the left for more content.

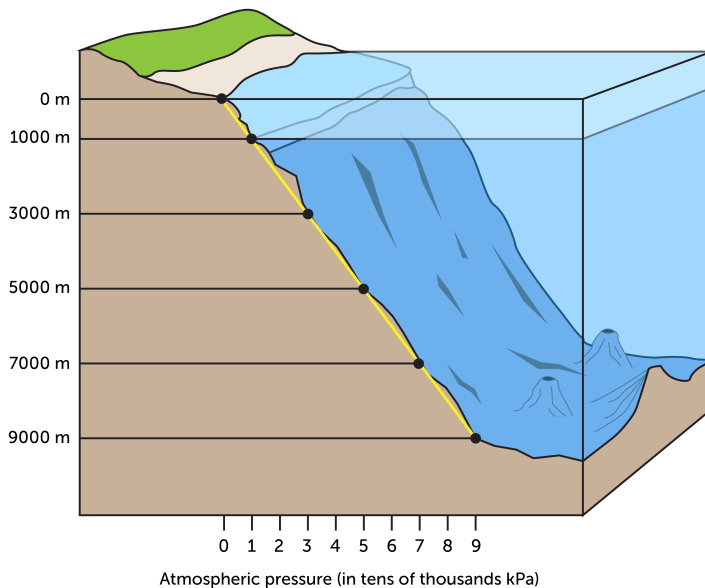

FIGURE 15.4

The pressure of ocean water increases rapidly as the water gets deeper.

Because of the pressure of the water, divers who go deeper than about 40 meters below the surface must return to the surface slowly and stop for several minutes at one or more points in their ascent. That's what the divers in **Figure 15.5** are doing. The stops are needed to let the pressure inside their body adjust to the decreasing pressure of the water as they swim closer to the surface. If they were to rise to the surface too quickly, the gases dissolved in their blood would form bubbles and cause serious health problems.

Air Pressure

Like water in the ocean, air in the atmosphere exerts pressure that increases with depth. Most gas molecules in the atmosphere are pulled close to Earth's surface by gravity. As a result, air pressure decreases quickly at lower altitudes and then more slowly at higher altitudes. This is illustrated in **Figure 15.6**. Air pressure is greatest at sea level, where the depth of the atmosphere is greatest. At higher altitudes, the pressure is less because the depth of

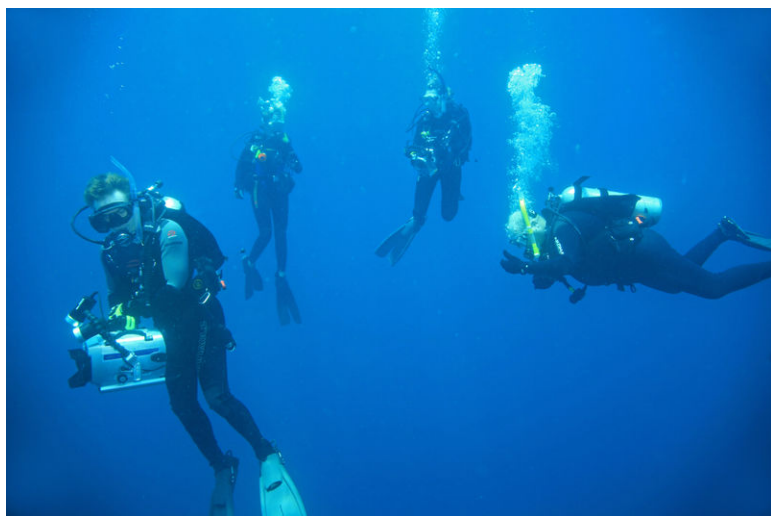
**FIGURE 15.5**

These scuba divers are taking a rest stop on their way up to the surface to adjust to decreasing water pressure.

the atmosphere is less. For example, on top of Mount Everest, the tallest mountain on Earth, air pressure is only about one-third of the pressure at sea level. At such high altitudes, low air pressure makes it hard to breathe and is dangerous to human health.

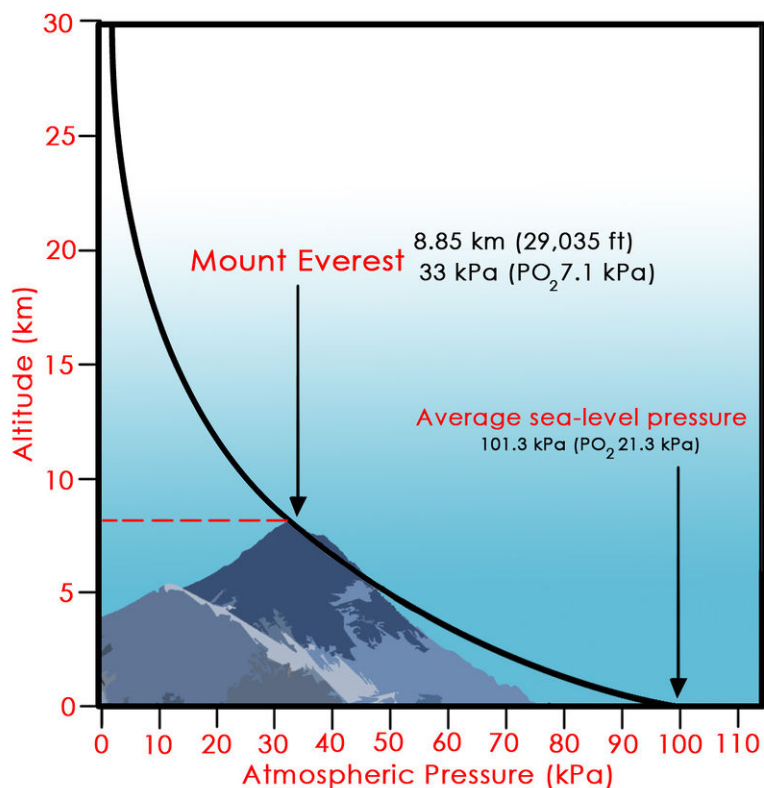
**FIGURE 15.6**

This graph shows how air pressure decreases with increasing altitude.

The pressure of air in the atmosphere allows you to do many things, from sipping through a straw to simply breathing (see **Figure 15.7**).

- When you first suck on a straw, you remove air from the straw, so the air pressure in the straw is lower than

the air pressure on the surface of the drink. Because fluid flows from an area of high to low pressure, the drink moves up the straw and into your mouth.

- When you breathe, a muscle called the diaphragm causes the rib cage and lungs to expand or contract. When they expand, the air in the lungs is under less pressure than the air outside the body, so air flows into the lungs. When the ribs and lungs contract, air in the lungs is under greater pressure than air outside the body, so air flows out of the lungs.

For more examples of how we use air pressure, watch the video at this URL: <http://www.youtube.com/watch?v=ZG29OJyZpyA> (3:06).



MEDIA

Click image to the left for more content.

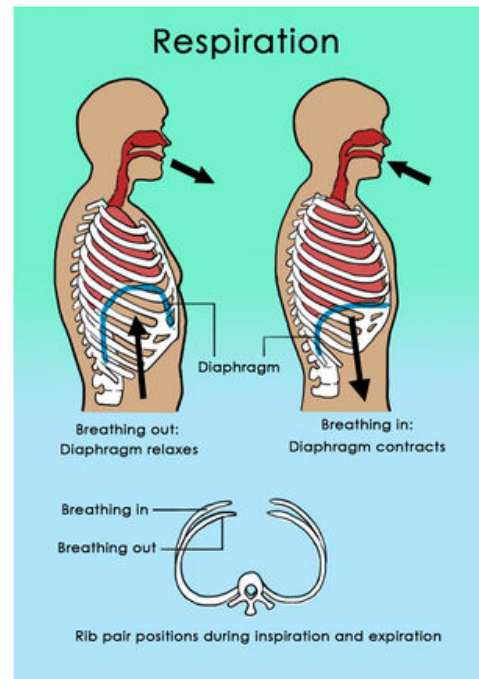

FIGURE 15.7

Both drinking through a straw and moving air into and out of the lungs is possible because of differences in air pressure. Can you think of other ways that differences in air pressure are useful?

Laws of Fluid Pressure

Some of the earliest scientific research on fluids was conducted by a French mathematician and physicist named Blaise Pascal (1623–1662). Pascal was a brilliant thinker. While still a teen, he derived an important theorem in mathematics and also invented a mechanical calculator. One of Pascal’s contributions to our understanding of fluids is known as Pascal’s law.

Pascal’s Law

Pascal’s law states that a change in pressure at any point in an enclosed fluid is transmitted equally throughout the fluid. A simple example may help you understand Pascal’s law. Assume you have a small packet of ketchup, like the one in **Figure 15.8**. If you open one end of the packet and then apply pressure to the other end, what will happen? Ketchup will squirt out the open end. The pressure you exert on the packet is transmitted throughout the ketchup. When the pressure reaches the open end, it forces ketchup out of the packet. To see a video about Pascal’s law, go to this URL: <http://www.youtube.com/watch?v=4uRnPTQxZtw> (2:59).



MEDIA

Click image to the left for more content.



FIGURE 15.8

Ketchup is a fluid, so it transmits pressure from one end of the packet to the other.

The ability of fluids to transmit pressure in this way can be very useful —besides providing ketchup for your French fries! For example, the hydraulic car lift in **Figure 15.9** contains fluid that transmits pressure and raises a car so a mechanic can work on it from below. The fluid used, usually a type of oil, can’t be compressed. Force is placed on the fluid in a narrow cylinder, and the fluid transmits the pressure throughout the hydraulic system. When the pressure reaches the fluid in the wide cylinder, it forces the cylinder upward, along with the car. The force applied to the car is much greater than the force applied to the fluid in the narrow cylinder. Why? When pressure acts over a wider area, it creates a larger force. That’s because force equals pressure multiplied by the area over which it acts, as you saw above in the equation $\text{Force} = \text{Pressure} \times \text{Area}$.



Hydraulic Car Lift

The car on the left was lifted by pressure transmitted through hydraulic fluid. The diagram below shows how a hydraulic lift works. The force applied to the car is greater than the force applied to the fluid in the small cylinder. Can you explain why?

Pressure is applied to hydraulic fluid in the small cylinder.



Pressure is applied by hydraulic fluid to the car.

FIGURE 15.9

Pascal's law explains why fluid can be used to transmit pressure in a car lift.

Besides hydraulic car lifts, other equipment that uses hydraulic fluid to increase force ranges from brakes to bulldozers. Even the controls in airplanes use hydraulics. Because of the force-multiplying effect, a flick of a switch can raise or lower heavy wing flaps or landing gear. You can see animations of hydraulic systems at these URLs:

- <http://science.howstuffworks.com/transport/engines-equipment/hydraulic1.htm>
- http://home.wxs.nl/~brink494/hydr_e.htm

Bernoulli's Law

Another important law about pressure in fluids was described by Daniel Bernoulli, a Swiss mathematician who lived during the 1700s. Bernoulli used mathematics to arrive at his law. **Bernoulli's law** states that pressure in a moving fluid is less when the fluid is moving faster. For an animation of this law, go to the URL below.

http://mitchellscience.com/bernoulli_law_animation

Bernoulli's law explains how the wings of both airplanes and birds create lift that allows flight (see **Figure 15.10**). The shape of the wings causes air to flow more quickly—and air pressure to be lower—above the wings than below them. This allows the wings to lift the plane or bird above the ground against the pull of gravity. A spoiler on a race car, like the one in **Figure 15.10**, works in the opposite way. Its shape causes air to flow more slowly—and air pressure to be greater—above the spoiler than below it. As a result, air pressure pushes the car downward, giving its wheels better traction on the track.

Lesson Summary

- All fluids exert pressure because their particles are constantly moving at random in all directions and bumping into things. Pressure can be represented by the equation: $\text{Pressure} = \frac{\text{Force}}{\text{Area}}$. The SI unit for pressure is the

The wings of airplanes and birds give them lift. This allows the plane to take off the ground and the hawk to soar high in the air without flapping its wings.



FIGURE 15.10

How does Bernoulli's law explain each of these examples?



The spoiler across the back of this car acts like an inverted wing. It causes air pressure to push the car towards the ground. How does this increase friction between the wheels and the road?

pascal (Pa), which equals 1 N/m^2 .

- Two factors that affect the pressure of fluids are depth and density. This explains why water pressure is greater deeper in the ocean and air pressure is greatest at sea level. Denser fluids, such as water, exert more pressure than less dense fluids, such as air.
- Pascal's law states that a change in pressure at any point in an enclosed fluid is transmitted equally throughout the fluid. This law is the basis of hydraulic equipment, such as hydraulic car lifts. Bernoulli's law states that pressure in a moving fluid is less when the fluid is moving faster. This law explains how the wings of both airplanes and birds create lift.

Lesson Review Questions

Recall

1. Define pressure.
2. What is the SI unit for pressure?
3. Identify two factors that affect the pressure of fluids.
4. Describe how pressure changes with depth in fluids.

Apply Concepts

5. Apply Pascal's law to explain why squeezing one end of a toothpaste tube causes toothpaste to squirt out the other end.
6. A box weighing 200 N is resting on the ground on an area of 1 m^2 . How much pressure is the box exerting on the ground?

Think Critically

7. Explain why fluids exert pressure.

8. Relate Bernoulli's law to lift in an airplane.

Points to Consider

If you've ever floated in water, you may have noticed that filling your lungs with air helps to keep you afloat.

- Why do you think having more air in your lungs helps you float in water?
- What other things float in water? What things don't float? How do they differ?

15.2 Buoyancy of Fluids

Lesson Objectives

- Describe the nature of buoyant force.
- State Archimedes' law.

Lesson Vocabulary

- Archimedes' law
- buoyancy
- buoyant force

Introduction

The fishing float in **Figure 15.11** bobs on the surface of the water. The fish in the figure is suspended in the water near the surface. Why do the float and fish stay on or near the surface? Why don't they sink? The answer is buoyancy, another property of fluids.

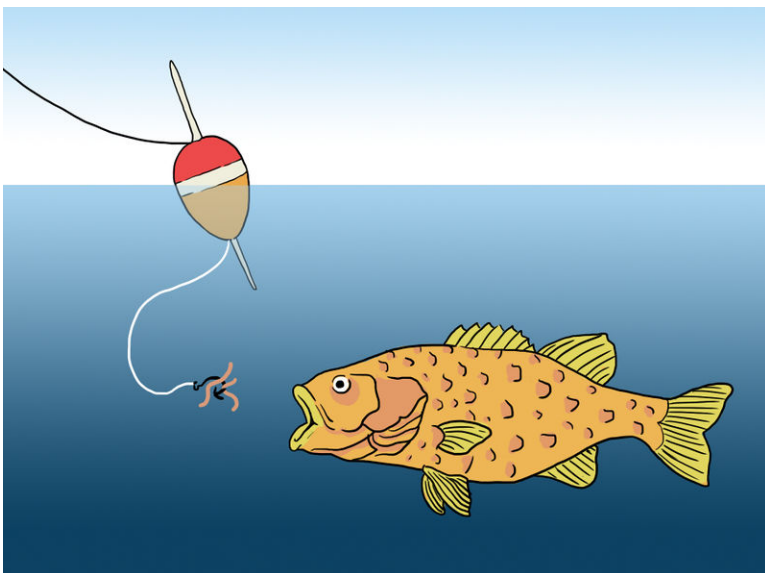

FIGURE 15.11

A fishing float keeps the fishing line near the surface so it doesn't sink to the bottom of the lake.

Buoyant Force

Buoyancy is the ability of a fluid to exert an upward force on any object placed in the fluid. This upward force is called **buoyant force**.

Pressure and Buoyant Force

What explains buoyant force? Recall from the earlier lesson "Pressure of Fluids" that a fluid exerts pressure in all directions but the pressure is greater at greater depth. Therefore, the fluid below an object exerts greater force on the object than the fluid above the object. This is illustrated in **Figure 15.12**. Buoyant force explains why objects may float in water. No doubt you've noticed, however, that some objects do not float in water. If buoyant force applies to all objects in fluids, why do some objects sink instead of float? The answer has to do with their weight.

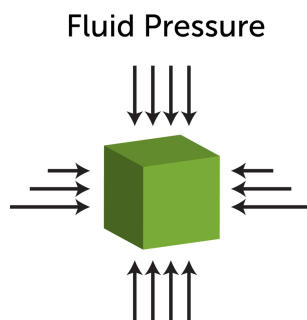

FIGURE 15.12

Fluid pressure exerts force on all sides of this object, but the force is greater at the bottom of the object where the fluid is deeper.

Weight and Buoyant Force

Weight is a measure of the force of gravity pulling down on an object. Buoyant force pushes up on an object. Weight and buoyant force together determine whether an object sinks or floats. This is illustrated in **Figure 15.13**.

- If an object's weight is less than the buoyant force acting on the object, then the object floats. This is the example on the left in **Figure 15.13**.
- If an object's weight is greater than the buoyant force acting on the object, then the object sinks. This is the example on the right in **Figure 15.13**.

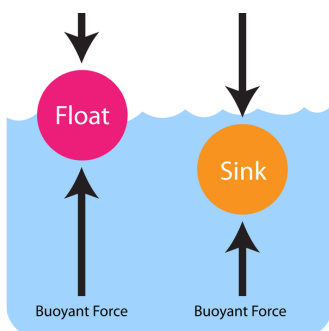

FIGURE 15.13

Whether an object sinks or floats depends on its weight and the strength of the buoyant force acting on it.

Because of buoyant force, objects seem lighter in water. You may have noticed this when you went swimming and could easily pick up a friend or sibling under the water. Some of the person's weight was countered by the buoyant force of the water.

Density and Buoyant Force

Density, or the amount of mass in a given volume, is also related to buoyancy. That's because density affects weight. A given volume of a denser substance is heavier than the same volume of a less dense substance. For example, ice is less dense than liquid water. This explains why ice cubes float in a glass of water. This and other examples of density and buoyant force are illustrated in **Figure 15.14** and in the video at this URL: <http://www.youtube.com/watch?v=VDSYXmvjg6M> (12:08).

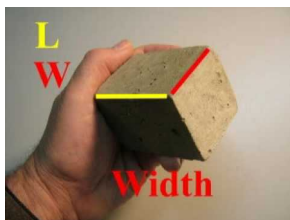

MEDIA

Click image to the left for more content.

Archimedes' Law

Did you ever notice that when you get into a bathtub of water the level of the water rises? More than 2200 years ago, a Greek mathematician named Archimedes noticed the same thing. He observed that both a body and the water in a tub can't occupy the same space at the same time. As a result, some of the water is displaced, or moved out of the way. How much water is displaced? Archimedes determined that the volume of displaced water equals the volume of the submerged object. So more water is displaced by a bigger body than a smaller one.

What does displacement have to do with buoyant force? Everything! Archimedes discovered that the buoyant force acting on an object in a fluid equals the weight of the fluid displaced by the object. This is known as **Archimedes' law** (or Archimedes' Principle).

Archimedes' law explains why some objects float in fluids even though they are very heavy. Remember the oil tanker that opened this chapter? It is extremely heavy, yet it stays afloat. If a steel ball with the same weight as the ship were put into water, it would sink to the bottom (see **Figure 15.15**). That's because the volume of water displaced by the steel ball weighs less than the ball. As a result, the buoyant force is not as great as the force of gravity acting on the ball. The design of the ship's hull, on the other hand, causes it to displace much more water than the ball. In fact, the weight of the displaced water is greater than the weight of the ship, so the buoyant force is greater than the force of gravity acting on the ship. As a result, the ship floats. You can check your understanding of Archimedes' law by doing the brainteaser at this URL: <http://www.pbs.org/wgbh/nova/lasalle/buoyquestion.html> .

For an entertaining video presentation of Archimedes' law, go to this URL: <http://videos.howstuffworks.com/discovery/6540-mythbusters-lets-talk-buoyancy-video.htm> .

Lesson Summary

- Buoyancy is the ability of a fluid to exert an upward force on any object placed in it. The upward force is called buoyant force. An object's weight and the buoyant force acting on it determine whether the object sinks



Unlike most substances, water is less dense in its solid than liquid state. This explains why ice cubes float in water.



If you add oil to water, the oil floats on the water because it is less dense than the water.



Helium balloons have to be weighted down with something heavy to keep them from floating up into the air. That's because helium is less dense than air.

FIGURE 15.14

The substances pictured here float in a fluid because they are less dense than the fluid.

or floats. Less dense objects and fluids float in fluids with greater density.

- The buoyant force acting on an object in a fluid equals the weight of the fluid displaced by the object. This is known as Archimedes' law (or Archimedes' Principle). It explains why some objects float in fluids even though they are very heavy.

Lesson Review Questions

Recall

1. What is buoyancy?
2. Describe how weight and buoyant force determine whether an object sinks or floats.
3. How is density related to buoyancy?

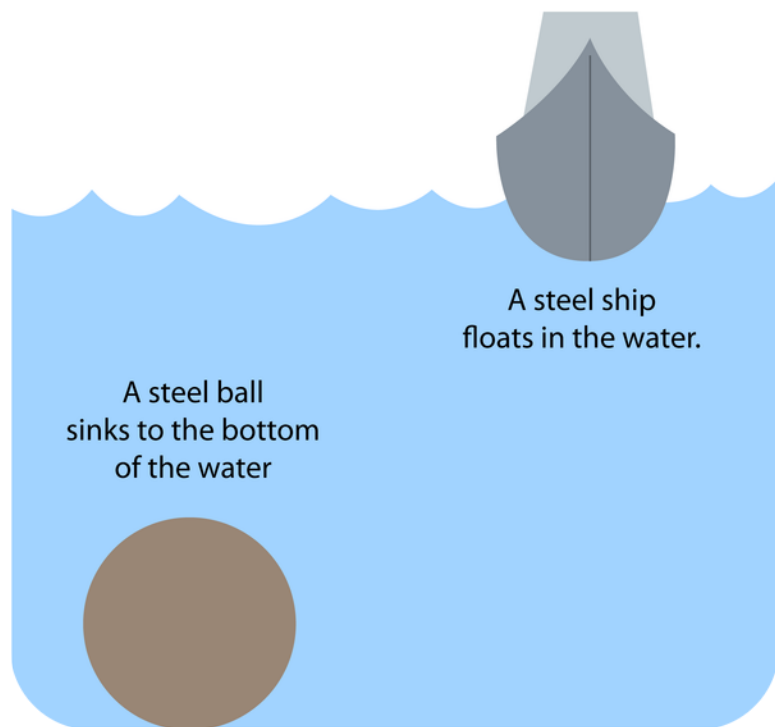
**FIGURE 15.15**

Archimedes' law explains why a heavy ship floats. Its shape causes it to displace more water than a ball of the same weight.

Apply Concepts

4. Apply Archimedes' law to explain why some very heavy objects float in water.

Think Critically

5. Relate displacement of a fluid by an object to the buoyant force acting on the object.

Points to Consider

In this chapter, you saw how pressure and buoyancy of fluids can be used to make work easier—from raising a car on a lift to floating a ship on the ocean. Devices that make work easier are called machines in physics.

- What are some examples of machines?
- How do these machines make work easier?

15.3 References

1. Joe Shlabotnik. <http://www.flickr.com/photos/joeshlabotnik/1856962308/> . CC BY 2.0
2. StockMonkeys.com (www.stockmonkeys.com). <http://www.flickr.com/photos/86530412@N02/7984329008/> . CC BY 2.0
3. Christopher Auyeung. [CK-12 Foundation](#) . CC BY-NC 3.0
4. Christopher Auyeung. [CK-12 Foundation](#) . CC BY-NC 3.0
5. Laszlo Ilyes (Flickr: laszlo-photo). <http://www.flickr.com/photos/laszlo-photo/2062961046/> . CC BY 2.0
6. Laura Guerin. [CK-12 Foundation](#) . CC BY-NC 3.0
7. Drinking: Marco Hamersma; Respiration: Laura Guerin. [Drinking:](#) <http://www.flickr.com/photos/marcohamersma/9380983515/>; [Respiration:](#) [CK-12 Foundation](#) . Drinking: CC BY 2.0; Respiration: CC BY-NC 3.0
8. Justin Taylor (Flickr:Bludgeoner86). <http://www.flickr.com/photos/bludgeoner86/8241144160/> . CC BY 2.0
9. Car (photo): Sean Freese; Car (diagram): Alejandro Tejada; Compiled by CK-12 Foundation. [Car \(photo\):](#) <http://www.flickr.com/photos/seanfreese/8084718707/>; [Car \(diagram\):](#) <http://openclipart.org/detail/23736/skoda-car-by-anonymous-23736> . Car (photo): CC BY 2.0; Car (diagram): Public Domain
10. Airplane: Adrian Pingstone (Wikimedia: Arpingstone); Bird: Matt Tillett; Car: Flickr:The Car Spy; composite by CK-12 Foundation. [Airplane:](#) <http://commons.wikimedia.org/wiki/File:Continental.b757-200.n19117.bristol arp.jpg>; [Bird:](#) http://commons.wikimedia.org/wiki/File:Cooper%27s_Hawk_2.jpg; [Car:](#) http://commons.wikimedia.org/wiki/File:2008_Porsche_911_997_Turbo_RUF_RT_12_-_Flickr_-_The_Car_Spy.jpg . Airplane: Public Domain ; Bird: CC BY 2.0 ; Car: CC BY 2.0
11. Laura Guerin. [CK-12 Foundation](#) . CC BY-NC 3.0
12. Christopher Auyeung. [CK-12 Foundation](#) . CC BY-NC 3.0
13. Christopher Auyeung. [CK-12 Foundation](#) . CC BY-NC 3.0
14. Glass of water: Flickr:alisdair; Oil in water: Flickr:yortw; Balloons: Mark Hillary. [Glass of water:](#) <http://www.flickr.com/photos/alisdair/199520227/>; [Oil in water:](#) <http://www.flickr.com/photos/yortw/5470226807/>; [Balloons:](#) <http://www.flickr.com/photos/markhillary/390974020/> . CC BY 2.0
15. Christopher Auyeung. [CK-12 Foundation](#) . CC BY-NC 3.0

CHAPTER 16

Work and Machines

Chapter Outline

- 16.1 WORK
- 16.2 MACHINES
- 16.3 SIMPLE MACHINES
- 16.4 COMPOUND MACHINES
- 16.5 REFERENCES

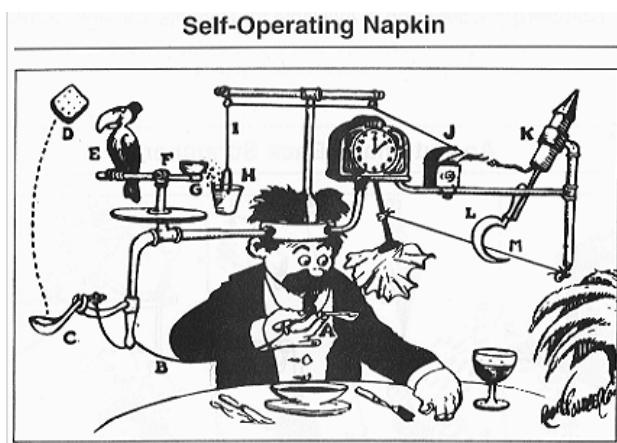

How the Self-Operating Napkin Works:

1. The man raises the soup spoon (A) to his mouth. This movement pulls the string (B), which jerks the ladle (C).
2. The ladle throws the cracker (D) past the parrot (E), which jumps for the cracker, causing the perch (F) to tilt.
3. When the perch tilts, it upsets the seeds (G) into the pail (H). The extra weight in the pail pulls the cord (I), which opens and lights the lighter (J).
4. The lighter sets off the skyrocket (K), which causes the sickle (L) to cut the string (M).
5. When the string is cut, it allows the pendulum with the attached napkin to swing back and forth, thereby wiping the man's chin.

A Rube Goldberg invention, like the "self-operating napkin" pictured here, is a needlessly complex machine that is used to complete a simple task. Rube Goldberg was an engineer and artist. He observed that people tend to find difficult ways to do simple things. He created silly cartoon machines, like the one above, to poke fun at this tendency. You can see some amazing Rube Goldberg-type machines in action by watching the videos at this URL: <http://hhe.wikispaces.com/Rube+Goldberg+Machines> .

In this chapter you'll learn about real machines, which —unlike Rube Goldberg inventions—actually make work easier. However, before learning about machines, you need to know what work means in physics. That's where this chapter begins.

Rube Goldberg. commons.wikimedia.org/wiki/File:Professor_Lucifer_Butts.gif. Public Domain.

16.1 Work

Lesson Objectives

- Define work, and state how to calculate it.
- Explain how power is related to work.

Lesson Vocabulary

- joule (J)
- power
- watt (W)
- work

Introduction

The teen playing tennis in **Figure 16.1** is having fun. The other teen in the same figure is working hard studying for an exam. You can tell by their faces which teen is doing work—or can you? Would it surprise you to learn that the teen who is working is the one who is having fun playing tennis, while the teen who is studying isn't doing any work at all? The reason why has to do with how work is defined in physics.



FIGURE 16.1

Which teen is doing work and which teen isn't?

Defining and Calculating Work

Work is defined differently in physics than in everyday language. In physics, **work** means the use of force to move an object. The teen who is playing tennis in **Figure 16.1** is using force to move her tennis racket, so she is doing work. The teen who is studying isn't moving anything, so she is not doing work.

Not all force that is used to move an object does work. For work to be done, the force must be applied in the same direction that the object moves. If a force is applied in a different direction than the object moves, no work is done. **Figure 16.2** illustrates this point. The stick person applies an upward force on the box when raising it from the ground to chest height. Work is done because the force is applied in the same direction as the box is moving. However, as the stick person walks from left to right while holding the box at chest height, no more work is done by the person's arms holding the box up. That's because the force supporting the box acts in a different direction than the box is moving. A small amount of work in the horizontal direction is performed when the person is accelerating during the first step of the walk across the room. But other than that, there is no work, because there is no net force acting on the box horizontally.

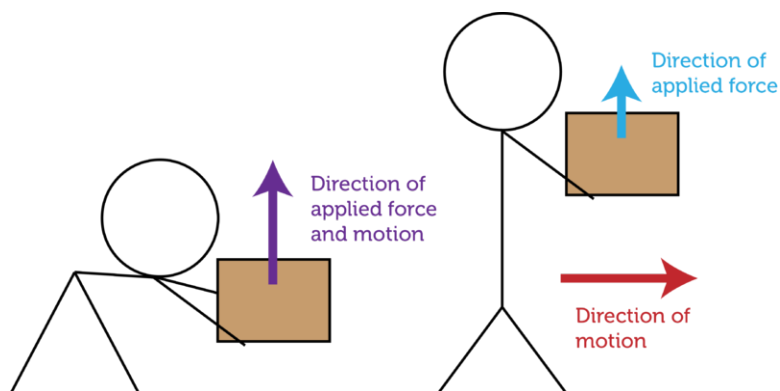

FIGURE 16.2

Carrying a box while walking does not result in work being done. Work is done only when the box is first lifted up from the ground. Can you explain why?

Work, Force, and Distance

Work is directly related to both the force applied to an object and the distance the object moves. It can be represented by the equation:

$$\text{Work} = \text{Force} \times \text{Distance}$$

This equation shows that the greater the force that is used to move an object or the farther the object is moved, the more work that is done. You can see a short video introduction to work as the product of force and distance at this link: <http://www.schooltube.com/video/85de91bb7097c101fbda/Eureka-Episode-8-Work> .

To see the effects of force and distance on work, compare the weight lifters in **Figure 16.3**. The two weight lifters on the left are lifting the same amount of weight, but the bottom weight lifter is lifting the weight a longer distance. Therefore, this weight lifter is doing more work. The two weight lifters on the bottom right are both lifting the weight the same distance, but the weight lifter on the left is lifting a heavier weight. Therefore, this weight lifter is doing more work.

Calculating Work

The equation for work given above can be used to calculate the amount of work that is done if force and distance are known. For example, assume that one of the weight lifters in **Figure 16.2** lifts a weight of 400 newtons over his head to a height of 2.2 meters off the ground. The amount of work he does is:

$$\text{Work} = 400 \text{ N} \times 2.2 \text{ m} = 880 \text{ N} \cdot \text{m}$$



◀ On the left, the bottom weight lifter is doing more work by lifting the weight a longer distance.

Below, the weight lifter on the left is doing more work by lifting a heavier weight.

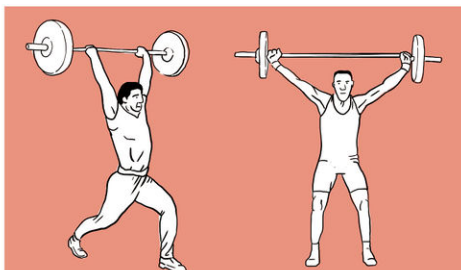

FIGURE 16.3

Weight lifters do more work when they move weights a longer distance or move heavier weights.

Notice that the unit for work is the newton · meter. This is the SI unit for work, also called the **joule (J)**. One joule equals the amount of work that is done when 1 newton of force moves an object over a distance of 1 meter.

Problem Solving

Problem: Todd pushed a 500 N box 4 meters across the floor. How much work did he do?

Solution: Use the equation $\text{Work} = \text{Force} \times \text{Distance}$.

$$\text{Work} = 500 \text{ N} \times 4 \text{ m} = 2000 \text{ N} \cdot \text{m}, \text{ or } 2000 \text{ J}$$

You Try It!

Problem: Lara lifted a 100 N box 1.5 meters above the floor. How much work did she do?

Work and Power

Did you ever rake leaves, like the woman in **Figure 16.4**? It can take a long time to do all that work. But if you use an electric leaf blower, like the man in the figure, the job gets done much sooner. Both the leaf blower and the rake do the work of removing leaves from the yard, but the leaf blower has more power. That's why it can do the same amount of work in less time.

What Is Power?

Power is a measure of the amount of work that can be done in a given amount of time. Power can be represented by the equation:

$$\text{Power} = \frac{\text{Work}}{\text{Time}}$$



FIGURE 16.4

Which way of removing leaves would take less effort on your part?

In this equation, work is measured in joules and time is measured in seconds, so power is expressed in joules per second (J/s). This is the SI unit for work, also known as the **watt (W)**. A watt equals 1 joule of work per second. The watt is named for James Watt, a Scottish inventor you will read about below.

You may already be familiar with watts. That's because light bulbs and small appliances such as hair dryers are labeled with the watts of power they provide. For example, the hair dryer in **Figure 16.5** is labeled "2000 watts." This amount of power could also be expressed kilowatts. A kilowatt equals 1000 watts, so the 2000-watt hair dryer produces 2 kilowatts of power.



FIGURE 16.5

Hair dryers vary in power. How do you think this affects drying time?

Compared with a less powerful device, a more powerful device can either do more work in the same time or do the same work in less time. For example, compared with a low-power microwave, a high-power microwave can cook more food in the same time or the same amount of food in less time.

Calculating Power or Work

Power can be calculated using the formula above, if the amount of work and time are known. For example, assume that a small engine does 3000 joules of work in 2 seconds. Then the power of the motor is:

$$\text{Power} = \frac{3000 \text{ J}}{2 \text{ s}} = 1500 \text{ J/s, or } 1500 \text{ W}$$

You can also calculate work if you know power and time by rewriting the power equation above as:

$$\text{Work} = \text{Power} \times \text{Time}$$

For example, if you use a 2000-watt hair dryer for 30 seconds, how much work is done? First express 2000 watts in J/s and then substitute this value for power in the work equation:

$$\text{Work} = 2000 \text{ J/s} \times 30 \text{ s} = 60,000 \text{ J}$$

For a video presentation on calculating power and work, go to this link: <http://www.brightstorm.com/science/physics/energy-and-momentum/power/> .

Problem Solving

Problem: An electric mixer does 2500 joules of work in 5 seconds. What is its power?

Solution: Use the equation: $\text{Power} = \frac{\text{Work}}{\text{Time}}$.

$$\text{Power} = \frac{2500 \text{ J}}{5 \text{ s}} = 500 \text{ J/s, or } 500 \text{ W}$$

You Try It!

Problem: How much work can be done in 30 seconds by a 1000-watt microwave?

Horsepower

Sometimes power is measured in a unit called the horsepower. One horsepower is the amount of work a horse can do in 1 minute. It equals 745 watts of power. The horsepower was introduced by James Watt, who invented the first powerful steam engine in the 1770s. Watt's steam engine led to a revolution in industry and agriculture because of its power. Watt wanted to impress people with the power of his steam engine, so he compared it with something familiar to people of his time: the power of workhorses, like those pictured in **Figure 16.6**. Watt said his steam engine could produce the power of 20 horses, or 20 horsepower. The most powerful engines today may produce more than 100,000 horsepower! How many watts of power is that?

Two horses supply 2 horsepower of power.



This tractor supplies up to 150 horsepower of power.



FIGURE 16.6

The horses and the tractor are both pulling a plow. The horses provide less horsepower than the tractor. Which do you think will get the job done faster?

Lesson Summary

- Work is the use of force to move an object. It can be calculated as the product of force and distance. The SI unit for work is the joule (J).

- Power is a measure of the amount of work that can be done in a given amount of time. The SI unit for power is the watt (W).

Lesson Review Questions

Recall

1. How is work defined in physics?
2. What does power measure?
3. Identify the SI units for work and power.

Apply Concepts

4. Jana lifted a 200-newton weight over her head to a distance of 2 meters above the ground. How much work did she do?
5. Pieter picked up a 20-newton book from the floor. Then he passed it to Ahmad, who carried it for 20 meters. How much work did Ahmad do?
6. If an electric mixer does 10,000 joules of work in 10 seconds, what is its power?

Think Critically

7. Explain how power is related to work.

Points to Consider

Machines such as the tractor and leaf blower you read about in this lesson help people do work.

- What are other examples of machines?
- What do all these machines have in common?

16.2 Machines

Lesson Objectives

- Explain how machines help us do work.
- Define efficiency, and state how it is calculated.
- Define mechanical advantage, and state how it is calculated.

Lesson Vocabulary

- efficiency
- machine
- mechanical advantage

Introduction

When you hear the word "machine," do you think of large appliances, power tools, factory machines, or construction equipment, like the examples pictured in **Figure 16.7**? While all of these examples are machines, you might be surprised to learn that devices as simple as hammers and screws are also machines. Why are these simple tools considered machines? Read on to find out.



FIGURE 16.7

Do you know what type of work each of these machines does?

How Machines Help Us Do Work

A **machine** is any device that makes work easier by changing a force. When you use a machine, you apply force to the machine. This force is called the input force. The machine, in turn, applies force to an object. This force is called the output force. Recall that work equals force multiplied by distance:

$$\text{Work} = \text{Force} \times \text{Distance}$$

The force you apply to a machine is applied over a given distance, called the input distance. The force applied by the machine to the object is also applied over a distance, called the output distance. The output distance may or may not be the same as the input distance.

Machines make work easier by increasing the amount of force that is applied, increasing the distance over which the force is applied, or changing the direction in which the force is applied. Contrary to popular belief, machines do not increase the amount of work that is done. They just change how the work is done. So if a machine increases the force applied, it must apply the force over a shorter distance. Similarly, if a machine increases the distance over which the force is applied, it must apply less force.

Increasing Force

Examples of machines that increase force are doorknobs and nutcrackers. **Figure 16.8** explains how these machines work. In each case, the force applied by the user is less than the force applied by the machine, but the machine applies the force over a shorter distance.

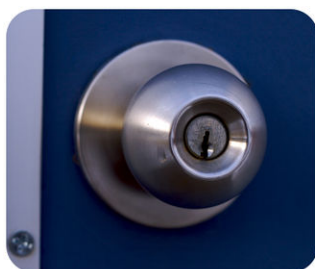

When you turn the large, wheel-like handle of the doorknob, it causes the slender central shaft of the doorknob to turn. The shaft turns a shorter distance but with more force. When it turns, it causes a small bar to move out of or into a slot in the doorframe, thus allowing the door to open or close.



When you press together the two handles of the nutcracker, it causes the other ends of the handles to squeeze the nut. The squeezing ends move a shorter distance but with greater force. This results in the nutshell cracking so you can get at the tasty nutmeat inside.

FIGURE 16.8

Both of these machines increase the force applied by the user, while reducing the distance over which the force is applied.

Increasing Distance

Examples of machines that increase the distance over which force is applied are paddles and hammers. **Figure 16.9** explains how these machines work. In each case, the machine increases the distance over which the force is applied, but it reduces the strength of the applied force.



When the boater pulls the handle ends of the paddles a short distance with strong force, the other ends of the paddles move a greater distance through the water, though with less force. To cover the greater distance, the paddle ends move faster than the handle ends. The water pushes back against the fast-moving paddles, causing the canoe to shoot forward.

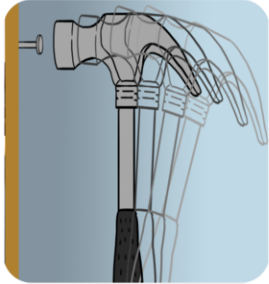

When a carpenter moves the handle of the hammer back and forth a short distance with strong force, the head of the hammer moves a greater distance back and forth against the nail, though with less force. By repeatedly hitting the nail, the hammer drives the nail into the board.

FIGURE 16.9

Both of these machines increase the distance over which force applied, while reducing the strength of the force.

Changing the Direction of Force

Some machines change the direction of the force applied by the user. They may or may not also change the strength of the force or the distance over which it is applied. Two examples of machines that work in this way are claw hammers and the rope systems (pulleys) that raise or lower flags on flagpoles. **Figure 16.10** explains how these machines work. In each case, the direction of the force applied by the user is reversed by the machine. How does this make it easier to do the job?



When the user of the hammer pushes down on the handle, the claw of the hammer pulls up on the nail. The hammer changes the direction of the force. It also applies greater force over a smaller distance.



The rope system on a flagpole wraps around a wheel called a pulley. When you pull down on one end of the rope, the other end of the rope pulls the flag upward.

FIGURE 16.10

Both of these machines change the direction over which force is applied. The claw hammer also increases the strength of the force.

Efficiency of Machines

You read above that machines do not increase the work done on an object. In other words, you can't get more work out of a machine than you put into it. In fact, machines always do less work on the object than the user does on the machine. That's because all machines must use some of the work put into them to overcome friction. How much work? It depends on the efficiency of the machine. **Efficiency** is the percent of input work that becomes output work. It is a measure of how well a machine reduces friction.

An Example: Efficiency of a Ramp

Consider the ramp in **Figure 16.11**. It's easier to push the heavy piece of furniture up the ramp to the truck than to lift it straight up off the ground. However, pushing the furniture over the surface of the ramp creates a lot of friction. Some of the force applied to moving the furniture must be used to overcome the friction. It would be more efficient to use a dolly on wheels to roll the furniture up the ramp. That's because rolling friction is much less than sliding friction. As a result, the efficiency of the ramp would be greater with a dolly.



FIGURE 16.11

A ramp is a machine because it makes work easier by changing a force. How does it change force?

Calculating Efficiency

Efficiency can be calculated with the equation:

$$\text{Efficiency} = \frac{\text{Output work}}{\text{Input work}} \times 100\%$$

Consider a machine that puts out 6000 joules of work. To produce that much work from the machine requires the user to put in 8000 joules of work. To find the efficiency of the machine, substitute these values into the equation for efficiency:

$$\text{Efficiency} = \frac{6000 \text{ J}}{8000 \text{ J}} \times 100\% = 75\%$$

You Try It!

Problem: Rani puts 10,000 joules of work into a car jack. The car jack, in turn, puts out 7000 joules of work to raise up the car. What is the efficiency of the jack?

Mechanical Advantage of Machines

Another measure of the effectiveness of a machine is its mechanical advantage. **Mechanical advantage** is the number of times a machine multiplies the input force. It can be calculated with the equation:

$$\text{Mechanical Advantage} = \frac{\text{Output force}}{\text{Input force}}$$

This equation computes the actual mechanical advantage of a machine. It takes into account the reduction in output force that is due to friction. It shows how much a machine actually multiplies force when it used in the real world.

Ideal Mechanical Advantage

It can be difficult to measure the input and output forces needed to calculate actual mechanical advantage. It's usually much easier to measure the input and output distances. These measurements can then be used to calculate the ideal mechanical advantage. The ideal mechanical advantage represents the multiplication of input force that would be achieved in the absence of friction. Therefore, it is greater than the actual mechanical advantage because all machines use up some work in overcoming friction. Ideal mechanical advantage is calculated with the equation:

$$\text{Ideal Mechanical Advantage} = \frac{\text{Input distance}}{\text{Output distance}}$$

Compare this equation with the equation above for actual mechanical advantage. Notice how the input and output values are switched. This makes sense when you recall that when a machine increases force, it decreases distance—and vice versa. You can watch a video about actual and ideal mechanical advantage at this link: <http://video.google.com/videoplay?docid=8517358537561483069#> .

Consider the simple ramp in **Figure 16.12**. A ramp can be used to raise an object up off the ground. The input distance is the length of the sloped surface of the ramp. The output distance is the height of the ramp, or the vertical distance the object is raised. Therefore, the ideal mechanical advantage of the ramp is:

$$\text{Ideal Mechanical Advantage} = \frac{6 \text{ m}}{2 \text{ m}} = 3$$

An ideal mechanical advantage of 3 means that the ramp ideally (in the absence of friction) multiplies the output force by a factor of 3.

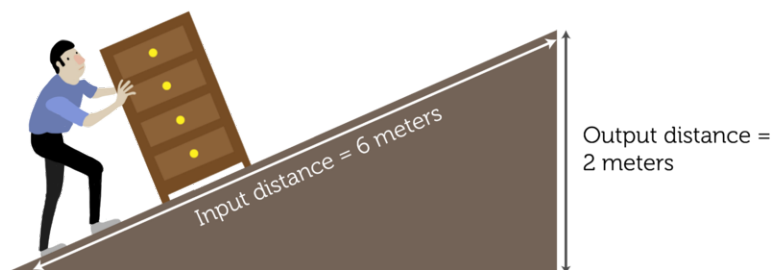
**FIGURE 16.12**

The input force is applied along the length of the sloping ramp surface. The output force is applied along the height of the ramp. The input distance is greater than the output distance. This means that the input force is less than the output force.

Mechanical Advantage and Type of Machine

As you read above, some machines increase the force put into the machine, while other machines increase the distance over which the force is applied. Still other machines change only the direction of the force. Which way a machine works affects its mechanical advantage.

- For machines that increase force—including ramps, doorknobs, and nutcrackers—the output force is greater than the input force. Therefore, the mechanical advantage is greater than 1.
- For machines that increase the distance over which force is applied, such as paddles and hammers, the output force is less than the input force. Therefore, the mechanical advantage is less than 1.
- For machines that change only the direction of the force, such as the rope systems on flagpoles, the output force is the same as the input force. Therefore, the mechanical advantage is equal to 1.

Lesson Summary

- A machine is any device that makes work easier by changing a force. A machine may increase force, increase the distance over which force is applied, or change the direction of force.
- The efficiency of a machine is a measure of how well it reduces friction. It is calculated as the percent of input work that becomes output work.
- The mechanical advantage of a machine is the number of times it multiplies the input force. The ideal mechanical advantage is the multiplication of force that would be achieved in the absence of friction. It is calculated as the input distance divided by the output distance.

Lesson Review Questions

Recall

1. What is a machine?
2. Identify three different ways that machines may change force.
3. What does efficiency measure?
4. Define actual mechanical advantage.
5. How does ideal mechanical advantage differ from actual mechanical advantage? How is ideal mechanical advantage calculated?

Apply Concepts

6. In the picture below, a screwdriver is being used to pry the lid off a paint can. The tip of the screwdriver is resting on the top edge of the can. When the handle of the screwdriver is pushed down, the tip of the screwdriver pushes up on the edge of the lid. Draw a simple labeled sketch to show the input and output distances involved in this work. How does the input distance compare with the output distance? Is the ideal mechanical advantage of the screwdriver greater than, less than, or equal to 1?



7. Assume that a machine puts out 8000 joules of work when the user puts in 10,000 joules of work. What is the efficiency of the machine?

Think Critically

8. The mechanical advantage of a machine is related to how it changes force. Explain this relationship.

Points to Consider

The canoe paddles, nutcracker, and hammer that you read about in this lesson have something in common. All three are examples of a type of simple machine called a lever.

- Based on these three examples, how would you describe a lever?
- How do you think a lever changes the force applied to it?

16.3 Simple Machines

Lesson Objectives

- Explain how an inclined plane changes force.
- List common examples of wedges and screws.
- Compare and contrast the three classes of levers.
- Describe two ways that a wheel and axle can be used.
- Identify three types of pulleys.

Lesson Vocabulary

- inclined plane
- lever
- pulley
- screw
- wedge
- wheel and axle

Introduction

Look at the axe head and the foot of the "doorstop man" in **Figure 16.13**. Do you see anything similar about them? What do you think they have in common? The answer is that both devices are a type of simple machine called a wedge. A wedge is just one of six types of simple machines. The others are the inclined plane, screw, lever, wheel and axle, and pulley. These six types of simple machines are the basis of all machines. More complex machines consist of two or more simple machines. In this lesson you'll learn how all six types of simple machines make work easier. You can explore animations of all six types at this link: <http://www.cosi.org/files/Flash/simpMach/sm1.swf> .



FIGURE 16.13

The axe head and the doorstop are both examples of a wedge, a type of simple machine.

Inclined Plane

The man in **Figure 16.14** is using a ramp to move a heavy dryer up to the back of a truck. The highway in the figure switches back and forth so it climbs up the steep hillside. Both the ramp and the highway are examples of inclined planes. An **inclined plane** is a simple machine consisting of a sloping surface that connects lower and higher elevations.



FIGURE 16.14

An inclined plane makes it easier to move objects to a higher elevation.

The sloping surface of the inclined plane supports part of the weight of the object as it moves up the slope. As a result, it takes less force to move the object uphill. The trade-off is that the object must be moved over a greater distance than if it were moved straight up to the higher elevation. On the other hand, the output force is greater than the input force because it is applied over a shorter distance. Like other simple machines, the ideal mechanical advantage of an inclined plane is given by:

$$\text{Ideal Mechanical Advantage} = \frac{\text{Input distance}}{\text{Output distance}}$$

For an inclined plane, the input distance is the length of the sloping surface, and the output distance is the maximum height of the inclined plane. This was illustrated in **Figure 16.12**. Because the sloping surface is always greater than the height of the inclined plane, the ideal mechanical advantage of an inclined plane is always greater than 1. An inclined plane with a longer sloping surface relative to its height has a gentler slope. An inclined plane with a gentler slope has a greater mechanical advantage and requires less input force to move an object to a higher elevation.

Wedge and Screw

Two simple machines that are based on the inclined plane are the wedge and the screw. Both increase the force used to move an object because the input force is applied over a greater distance than the output force.

Wedge

Imagine trying to slice a tomato with a fork or spoon instead of a knife, like the one in **Figure 16.15**. The knife makes the job a lot easier because of the wedge shape of the blade. A **wedge** is a simple machine that consists of two inclined planes. But unlike one inclined plane, a wedge works only when it moves. It has a thin end and thick end, and the thin end is forced into an object to cut or split it. The chisel in **Figure 16.15** is another example of a wedge.

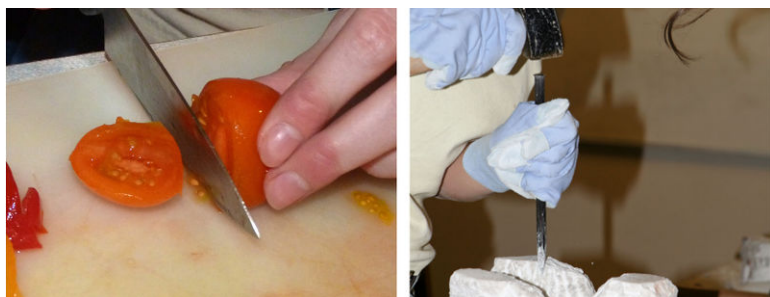

FIGURE 16.15

The thin edge of a knife or chisel enters an object and forces it apart.

The input force is applied to the thick end of a wedge, and it acts over the length of the wedge. The output force pushes against the object on both sides of the wedge, so the output distance is the thickness of the wedge. Therefore, the ideal mechanical advantage of a wedge can be calculated as:

$$\text{Ideal Mechanical Advantage} = \frac{\text{Length of wedge}}{\text{Maximum thickness of wedge}}$$

The length of a wedge is always greater than its maximum thickness. As a result, the ideal mechanical advantage of a wedge is always greater than 1.

Screw

The spiral staircase in **Figure 16.16** also contains an inclined plane. Do you see it? The stairs that wrap around the inside of the walls make up the inclined plane. The spiral staircase is an example of a screw. A **screw** is a simple machine that consists of an inclined plane wrapped around a cylinder or cone. No doubt you are familiar with screws like the wood screw in **Figure 16.16**. The screw top of the container in the figure is another example. Screws move objects to a higher elevation (or greater depth) by increasing the force applied.



FIGURE 16.16

All of these examples are screws. Can you identify the inclined plane in each example?

When you use a wood screw, you apply force to turn the inclined plane. The output force pushes the screw into the wood. It acts along the length of the cylinder around which the inclined plane is wrapped. Therefore, the ideal mechanical advantage of a screw is calculated as:

$$\text{Ideal Mechanical Advantage} = \frac{\text{Length of inclined plane}}{\text{Length of screw}}$$

The length of the inclined plane is always greater than the length of the screw. As a result, the mechanical advantage of a screw is always greater than 1.

Look at the collection of screws and bolts in **Figure 16.17**. In some of them, the turns (or threads) of the inclined plane are closer together. The closer together the threads are, the longer the inclined plane is relative to the length of the screw or bolt, so the greater its mechanical advantage is. Therefore, if the threads are closer together, you need to apply less force to penetrate the wood or other object. The trade-off is that more turns of the screw or bolt are needed to do the job because the distance over which the input force must be applied is greater.



FIGURE 16.17

The threads of a screw or bolt may be closer together or farther apart. How does this affect its ideal mechanical advantage?

Lever

Did you ever use a hammer to pull a nail out of a board? If not, you can see how it's done in **Figure 16.18**. When you pull down on the handle of the hammer, the claw end pulls up on the nail. A hammer is an example of a lever. **A lever** is a simple machine consisting of a bar that rotates around a fixed point called the fulcrum. For a video introduction to levers using skateboards as examples, go to this link: <http://www.youtube.com/watch?v=72ZNEactb-k> (1:35).



MEDIA

Click image to the left for more content.

A lever may or may not increase the force applied, and it may or may not change the direction of the force. It all depends on the location of the input and output forces relative to the fulcrum. In this regard, there are three basic types of levers, called first-class, second-class, and third-class levers. **Figure 16.19** describes the three classes.

**FIGURE 16.18**

Using a hammer to remove a nail changes both the direction and strength of the applied force. Where is the fulcrum of the hammer when it is used in this way?

Comparing Classes of Levers

All three classes of levers make work easier, but they do so in different ways.

- When the input and output forces are on opposite sides of the fulcrum, the lever changes the direction of the applied force. This occurs only with a first-class lever.
- When both the input and output forces are on the same side of the fulcrum, the direction of the applied force does not change. This occurs with both second- and third-class levers.
- When the input force is applied farther from the fulcrum, the input distance is greater than the output distance, so the ideal mechanical advantage is greater than 1. This always occurs with second-class levers and may occur with first-class levers.
- When the input force is applied closer to the fulcrum, the input distance is less than the output distance, so the ideal mechanical advantage is less than 1. This always occurs with third-class levers and may occur with first-class levers.
- When both forces are the same distance from the fulcrum, the input distance equals the output distance, so the ideal mechanical advantage equals 1. This occurs only with first class-levers.

Advantage of Third-Class Levers

You may be wondering why you would use a third-class lever when it doesn't change the direction or strength of the applied force. The advantage of a third-class lever is that the output force is applied over a greater distance than the input force. This means that the output end of the lever must move faster than the input end. Why would this be useful when you are moving a hockey stick or baseball bat, both of which are third-class levers?

Wheel and Axle

Did you ever ride on a Ferris wheel, like the one pictured in **Figure 16.20**? If you did, then you know how thrilling the ride can be. A Ferris wheel is an example of a wheel and axle. A **wheel and axle** is a simple machine that consists of two connected rings or cylinders, one inside the other, which both turn in the same direction around a single center point. The smaller, inner ring or cylinder is called the axle. The bigger, outer ring or cylinder is called the wheel. The car steering wheel in **Figure 16.20** is another example of a wheel and axle.

In a wheel and axle, force may be applied either to the wheel or to the axle. In both cases, the direction of the force does not change, but the force is either increased or applied over a greater distance.

- When the input force is applied to the axle, as it is with a Ferris wheel, the wheel turns with less force, so the ideal mechanical advantage is less than 1. However, the wheel turns over a greater distance, so it turns faster







Class of Lever	Example	Location of Input & Output Forces & Fulcrum	Ideal Mechanical Advantage	Change in Direction of Force?
First class			IMA = 1	yes
			IMA < 1	yes
			IMA > 1	yes
Second class			IMA > 1	no
Third class			IMA < 1	no

FIGURE 16.19

Which class of lever would you use to carry a heavy load, sweep a floor, or pry open a can of paint?

than the axle. The speed of the wheel is one reason that the Ferris wheel ride is so exciting.

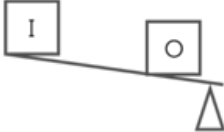
- When the input force is applied to the wheel, as it is with a steering wheel, the axle turns over a shorter distance but with greater force, so the ideal mechanical advantage is greater than 1. This allows you to turn the steering wheel with relatively little effort, while the axle of the steering wheel applies enough force to turn the car.



Where is the force applied in each wheel and axle pictured here? Is it applied to the axle or to the wheel?



FIGURE 16.20

Both a Ferris wheel and a car steering wheel have an outer wheel and an inner axle.

Pulley

Another simple machine that uses a wheel is the pulley. A **pulley** is a simple machine that consists of a rope and grooved wheel. The rope fits into the groove in the wheel, and pulling on the rope turns the wheel. **Figure 16.21** shows two common uses of pulleys.



Small pulleys are used to help control the shape of the sail on a boat. When you pull the cord, it rotates around the small wheel below the boom to move the boom downward.

Large pulleys are used to raise heavy objects with a crane. When the cords are pulled, they rotate around the large wheels just above the object, raising the object up.



FIGURE 16.21

In both of these examples, pulling the rope turns the wheel of the pulley.

Some pulleys are attached to a beam or other secure surface and remain fixed in place. They are called fixed pulleys. Other pulleys are attached to the object being moved and are moveable themselves. They are called moveable pulleys. Sometimes, fixed and moveable pulleys are used together. They make up a compound pulley. The three types of pulleys are compared in **Figure 16.22**. In all three types, the ideal mechanical advantage is equal to the number of rope segments pulling up on the object. The more rope segments that are helping to do the lifting work, the less force that is needed for the job. You can experiment with an interactive animation of compound pulleys with various numbers of pulleys at this link: <http://www.walter-fendt.de/ph14e/pulleyssystem.htm> .

- In a single fixed pulley, only one rope segment lifts the object, so the ideal mechanical advantage is 1. This

type of pulley doesn't increase the force, but it does change the direction of the force. This allows you to use your weight to pull on one end of the rope and more easily raise the object attached to the other end.

- In a single moveable pulley, two rope segments lift the object, so the ideal mechanical advantage is 2. This type of pulley doesn't change the direction of the force, but it does increase the force.
- In a compound pulley, two or more rope segments lift the object, so the ideal mechanical advantage is equal to or greater than 2. This type of pulley may or may not change the direction of the force, depending on the number and arrangement of pulleys. When several pulleys are combined, the increase in force may be very great.

To learn more about the mechanical advantage of different types of pulleys, watch the video at this link: <http://video.google.com/videoplay?docid=8517358537561483069#> .

Lesson Summary

- An inclined plane is a simple machine consisting of a sloping surface that connects lower and higher elevations. The ideal mechanical advantage of an inclined plane is always greater than 1.
- A wedge is a simple machine that consists of two inclined planes. A screw is a simple machine that consists of an inclined plane wrapped around a cylinder or cone. The ideal mechanical advantage of wedges and screws is always greater than 1.
- A lever is a simple machine that consists of a bar that rotates around a fixed point called the fulcrum. There are three classes of levers. Depending on its class, a lever may have an ideal mechanical advantage that is less than, equal to, or greater than 1. First-class levers also change the direction of the input force.
- A wheel and axle is a simple machine that consists of two connected rings or cylinders, one inside the other, which both turn in the same direction around a single center point. When force is applied to the inner axle, the ideal mechanical advantage is less than 1. When force is applied to the outer wheel, the ideal mechanical advantage is greater than 1.
- A pulley is a simple machine that consists of a rope and grooved wheel. Single pulleys may be fixed or moveable. Single and moveable pulleys may be combined in a compound pulley. The ideal mechanical advantage of a pulley or compound pulley is always equal to or greater than 1. Fixed pulleys and some compound pulleys also change the direction of the input force.

Lesson Review Questions

Recall

1. What is an inclined plane?
2. Give an example of a wedge. What work does it do?
3. How does force change when it is applied to the axle of a wheel and axle?
4. What determines the ideal mechanical advantage of a pulley?

Apply Concepts

5. A leaf rake is a type of lever. Where is the fulcrum and where are the input and output forces applied? Which class of lever is a rake? Explain your answer.





Type of Pulley	Example	How it Works	No. of Rope Segments Pulling up	Ideal Mechanical Advantage	Change in Direction of Force?
Single fixed pulley	<p>Flagpole pulley</p> 		1	1	yes yes yes
Single movable pulley	<p>Zip-line pulley</p> 		2	2	no
Compound pulley (fixed & movable pulleys)	<p>Crane pulley</p> 		≥ 2	≥ 2	no

FIGURE 16.22

Single pulleys may be fixed or moveable. Compound pulleys consist of two or more pulleys.

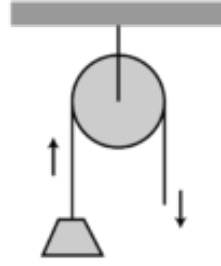
Think Critically

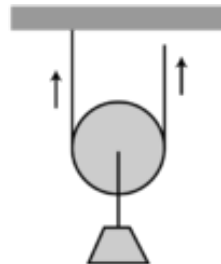
6. Explain why inclined planes, wedges, and screws always have an ideal mechanical advantage greater than 1.
7. Compare and contrast the three classes of levers.

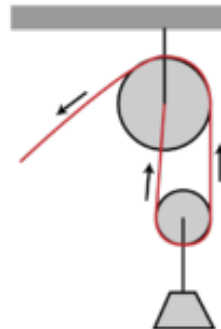
Points to Consider

In this lesson, you read that a compound pulley consists of two or more single pulleys. Many other machines also consist of two or more simple machines.

- Can you think of additional examples of machines that consist of more than one simple machine? Which simple machines do they contain?
- How might combining simple machines into a more complex machine affect efficiency and mechanical advantage?

16.4 Compound Machines

Lesson Objectives

- Give examples of compound machines.
 - Describe the efficiency and mechanical advantage of compound machines.
-

Lesson Vocabulary

- compound machine
-

Introduction

Did you ever look closely at the moving parts of a bicycle, like the mountain bike gears in **Figure 16.23**? If you did, then you observed several simple machines, including wheels and axles, pulleys, and levers. A bicycle is an example of a compound machine.



FIGURE 16.23

What simple machines do you see in this photo of bicycle gears?

What Is a Compound Machine?

A **compound machine** is a machine that consists of more than one simple machine. Some compound machines consist of just two simple machines. For example, a wheelbarrow consists of a lever, as you read earlier in the lesson

"Simple Machines," and also a wheel and axle. Other compound machines, such as cars, consist of hundreds or even thousands of simple machines. Two common examples of compound machines are scissors and fishing rods with reels. To view a young student's compound machine invention that includes several simple machines, watch the video at this link: http://www.youtube.com/watch?v=e4LUaAwuh_U . To see if you can identify the simple machines in a lawn mower, go to the URL below and click on "Find the Simple Machines."

<http://www.cosi.org/files/Flash/simpMach/sm2.html>

Scissors

Look at the scissors in **Figure 16.24**. As you can see from the figure, scissors consist of two levers and two wedges. You apply force to the handle ends of the levers, and the output force is exerted by the blade ends of the levers. The fulcrum of both levers is where they are joined together. Notice that the fulcrum lies between the input and output points, so the levers are first-class levers. They change the direction of force. They may or may not also increase force, depending on the relative lengths of the handles and blades. The blades themselves are wedges, with a sharp cutting edge and a thicker dull edge.

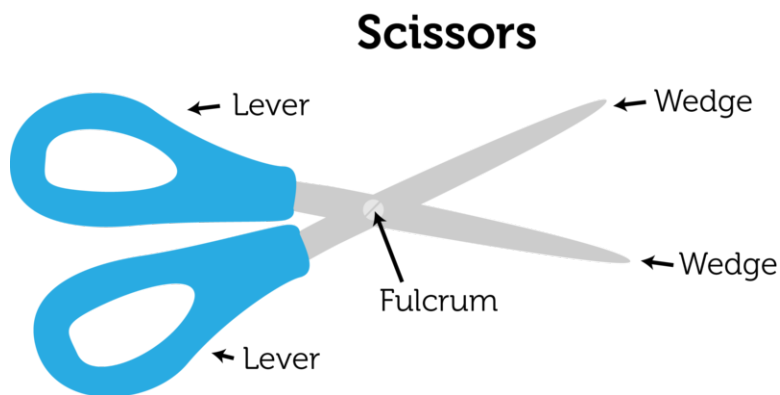

FIGURE 16.24

A pair of scissors is a compound machine consisting of levers and wedges.

Fishing Rod with Reel

The fishing rod with reel shown in **Figure 16.25** is another compound machine. The rod is a third-class lever, with the fulcrum on one end of the rod, the input force close to the fulcrum, and the output force at the other end of the rod. The output distance is greater than the input distance, so the angler can fling the fishing line far out into the water with just a flick of the wrist. The reel is a wheel and axle that works as a pulley. The fishing line is wrapped around the wheel. Using the handle to turn the axle of the wheel winds or unwinds the line.

Efficiency and Mechanical Advantage of Compound Machines

Because compound machines have more moving parts than simple machines, they generally have more friction to overcome. As a result, compound machines tend to have lower efficiency than simple machines. When a compound machine consists of a large number of simple machines, friction may become a serious problem, and it may produce a lot of heat. Lubricants such as oil or grease may be used to coat the moving parts so they slide over each other more easily. This is how a car's friction is reduced.

Compound machines have a greater mechanical advantage than simple machines. That's because the mechanical

Fishing Rod with Reel

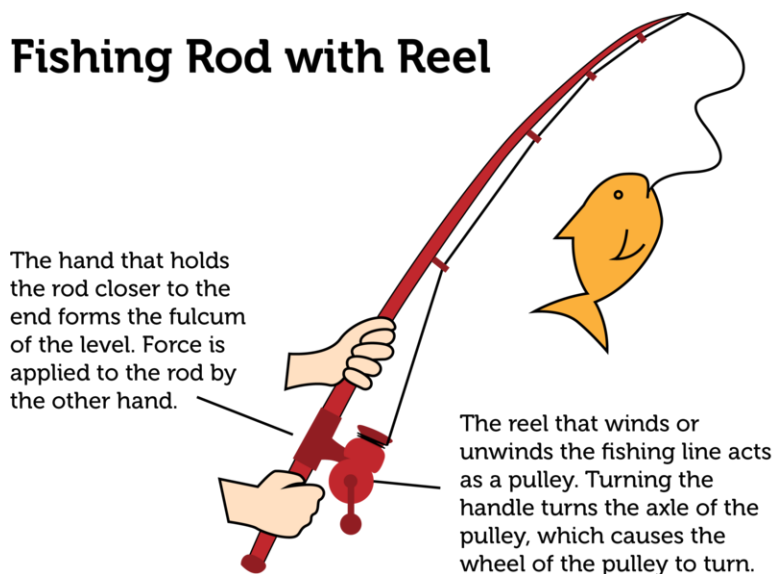

FIGURE 16.25

As a third-class lever, how does a fishing rod change the force applied to the rod? How does the reel help land the fish?

advantage of a compound machine equals the product of the mechanical advantages of all its component simple machines. The greater the number of simple machines it contains, the greater is its mechanical advantage.

Lesson Summary

- A compound machine consists of two or more simple machines. Examples of compound machines include bicycles, cars, scissors, and fishing rods with reels.
- Compound machines generally have lower efficiency but greater mechanical advantage than simple machines.

Lesson Review Questions

Recall

1. What is a compound machine?
2. Give two examples of compound machines.
3. How is the mechanical advantage of a compound machine calculated?

Apply Concepts

4. The can opener in the picture below is a compound machine. Identify two simple machines it contains.



Think Critically

5. Explain why the efficiency of compound machines is generally less than the efficiency of simple machines.

Points to Consider

Some of the machines you read about in this chapter require electricity in order to work. Electricity is a form of energy.

- What is energy?
- Besides electricity, what might be other forms of energy?

“Compound Machines” review question number 4: can opener image copyright tab62, 2013. <http://www.shutterstock.com> . Used under license from Shutterstock.com.

16.5 References

1. Tennis: Tim Donovan (Flickr:donovanshots); Studying: Flickr:English106. Tennis: <http://www.flickr.com/photos/donovanshots/8691771672/>; Studying: <http://www.flickr.com/photos/english106/4357228667/> . CC BY 2.0
2. Christopher Auyeung. [CK-12 Foundation](#) . CC BY-NC 3.0
3. Laura Guerin. [CK-12 Foundation](#) . CC BY-NC 3.0
4. Raking leaves: Robert Lopez; Leaf blower: Daniel Lobo (Flickr:Daquella manera). Raking leaves: [CK-12 Foundation](#); Leaf blower: <http://www.flickr.com/photos/daquellamanera/298174384/> . CC BY 2.0
5. Laura Guerin. [CK-12 Foundation](#) . CC BY-NC 3.0
6. Horses: Martin Pettitt; Tractor: David Wright. Horses: <http://www.flickr.com/photos/mdpettitt/269398599/>; Tractor: <http://www.flickr.com/photos/dhwright/6312683001/> . CC BY 2.0
7. Washer: Bart Everson (Flickr:Editor B); Lawn mower: Flickr:Shardayyy; Mixer: Ryan Snyder; Bulldozer: Terinea IT Support; Power drill: Steven Depolo; Forklift: Vitaly Volkov (Flickr:vitalyzator). Washer: <http://www.flickr.com/photos/editor/2734922201/>; Lawn mower: <http://www.flickr.com/photos/shardayyy/4586974249/>; Mixer: <http://www.flickr.com/photos/ryansnyder/6799745062/>; Bulldozer: <http://www.flickr.com/photos/terinea/536245891/>; Power drill: <http://www.flickr.com/photos/stevendepolo/3015110514/>; Forklift: <http://www.flickr.com/photos/70475110@N00/80906844/> . CC BY 2.0
8. Doorknob: Terry Johnston; Nutcracker: Flickr:Rhys A.. Doorknob: <http://www.flickr.com/photos/powerbooktrance/371470374/>; Nutcracker: <http://www.flickr.com/photos/rhysaplundh/8264630168/> . CC BY 2.0
9. Rower: Michael W Murphy (Flickr:michaelwm25); Hammer: Laura Guerin. Rower: <http://www.flickr.com/photos/michaelwm25/9438705332/>; Hammer: [CK-12 Foundation](#) . Rower: CC BY 2.0; Hammer: CC BY-NC 3.0
10. Robert Lopez (photo) and Laura Guerin (illustration). [CK-12 Foundation](#) . CC BY-NC 3.0
11. Laura Guerin. [CK-12 Foundation](#) . CC BY-NC 3.0
12. Laura Guerin. [CK-12 Foundation](#) . CC BY-NC 3.0
13. Axe: Rebecca Siegel (Flickr:grongar); Doorstop: David Wall (Flickr:Dwonderwall). Axe: <http://www.flickr.com/photos/grongar/8361707995/>; Doorstop: <http://www.flickr.com/photos/dwonderwall/3341418670/> . CC BY 2.0
14. Inclined plane: Image copyright Christina Richards, 2013; Road: Horia Varlan. Inclined plane: <http://www.shutterstock.com>; Road: <http://www.flickr.com/photos/horiavarlan/4259933727/> . Inclined plane: Used under license from Shutterstock.com; Road: CC BY 2.0
15. Knife: Flickr:normanack; Chisel: Andrew Magill. Knife: <http://www.flickr.com/photos/29278394@N00/720149818/>; Chisel: <http://www.flickr.com/photos/amagill/290331276/> . CC BY 2.0
16. Spiral staircase: Karel Jakubec (Wikimedia: Karelj); Screws: Pascal (Flickr:pasukaru76); Jar: Dwight Burdette. Stairs: http://commons.wikimedia.org/wiki/File:Spiral_staircase_in_the_Vatican_Museums_2011_04.jpg; Srews: <http://www.flickr.com/photos/pasukaru76/3629604891/>; Jar: http://commons.wikimedia.org/wiki/Category:Mason_jars . Stairs: Public Domain; Screws: CC BY 2.0; Jar: CC BY 3.0
17. Christian Schnettelker (<http://www.manoftaste.de/>). <http://www.flickr.com/photos/96913861@N04/10001342613/> . CC BY 2.0
18. Robert Lopez. [CK-12 Foundation](#) . CC BY-NC 3.0
19. Christopher Auyeung and Laura Guerin. [photo](#) . CC BY-NC 3.0
20. Ferris wheel: AJ Batac; Steering wheel: Robert Lopez. Ferris wheel: <http://www.flickr.com/photos/ajbatac/6970134222/>; Steering wheel: [CK-12 Foundation](#) . Ferris wheel: CC BY 2.0; Steering wheel: CC BY-NC 3.0
21. Pulley: Les Chatfield (Flickr: Elsie esq.); Crane: Flickr:OiMax. Pulley: <http://www.flickr.com/photos/elsie/2893140066/>; Crane: <http://www.flickr.com/photos/oimax/273930741/> . CC BY 2.0
22. Flag: Laura Guerin; Zip line: New Brunswick Tourism; Crane: Flickr:OiMax. Flag: [CK-12 Foundation](#);

- Zip line: <http://www.flickr.com/photos/tourismnewbrunswick/6088556853/>; Crane: <http://www.flickr.com/photos/oimax/273930741/> . Flag: CC BY-NC 3.0; Zip line: CC BY 2.0; Crane: CC BY 2.0
23. Sharada Prasad. <http://www.flickr.com/photos/sharadaprasad/3668336064/> . CC BY 2.0
 24. Christopher Auyeung. [CK-12 Foundation](#) . CC BY-NC 3.0
 25. Christopher Auyeung. [CK-12 Foundation](#) . CC BY-NC 3.0

CHAPTER 17**Introduction to Energy****Chapter Outline**

- 17.1 TYPES OF ENERGY**
 - 17.2 FORMS OF ENERGY**
 - 17.3 ENERGY RESOURCES**
 - 17.4 REFERENCES**
-



The whirring blades of these wind turbines look stark against the darkening sky at sunset. The energy of the wind causes the blades to spin, and the energy of the spinning blades is used to generate electricity. People have been using wind for energy for centuries. Until about 200 years ago, for example, ships depended on wind to sail the oceans. And windmills have long been used to gather wind energy to pump water and do other useful work. Today, wind energy is making a comeback. Do you know why? What might be advantages of using the wind for energy? This chapter has the answers.

Lee Bailey. www.flickr.com/photos/leebailey/6066524282/. CC BY 2.0.

17.1 Types of Energy

Lesson Objectives

- Relate energy to work.
- Describe kinetic energy.
- Identify two types of potential energy.
- Give examples of energy conversions between potential and kinetic energy.

Lesson Vocabulary

- energy conversion
- potential energy

Introduction

Did you ever babysit younger children, like the children in **Figure 17.1**? If you did, then you probably noticed that young children are often very active. They seem to be in constant motion. It may be hard to keep up with their boundless energy. What is energy, and where does it come from? Read on to find out.



FIGURE 17.1

Young children seem to be full of energy.

Defining Energy

The concept of energy was first introduced in the chapter "States of Matter," where it is defined as the ability to cause change in matter. Energy can also be defined as the ability to do work. Work is done whenever a force is used to move matter. When work is done, energy is transferred from one object to another. For example, when the batter in **Figure 17.2** uses energy to swing the bat, she transfers energy to the bat. The moving bat, in turn, transfers energy to the ball. Like work, energy is measured in the joule (J), or newton-meter (N·m).



FIGURE 17.2

It takes energy to swing a bat. Where does the batter get her energy?

Energy exists in different forms, which you can read about in the lesson "Forms of Energy" later in the chapter. Some forms of energy are mechanical, electrical, and chemical energy. Most forms of energy can also be classified as kinetic or potential energy. Kinetic and potential forms of mechanical energy are the focus of this lesson. Mechanical energy is the energy of objects that are moving or have the potential to move.

Kinetic Energy

What do all the photos in **Figure 17.3** have in common? All of them show things that are moving. Kinetic energy is the energy of moving matter. Anything that is moving has kinetic energy—from the atoms in matter to the planets in solar systems. Things with kinetic energy can do work. For example, the hammer in the photo is doing the work of pounding the nail into the board. You can see a cartoon introduction to kinetic energy and its relation to work at this URL: <http://www.youtube.com/watch?v=zhX01toLjZs> .

The amount of kinetic energy in a moving object depends on its mass and velocity. An object with greater mass or

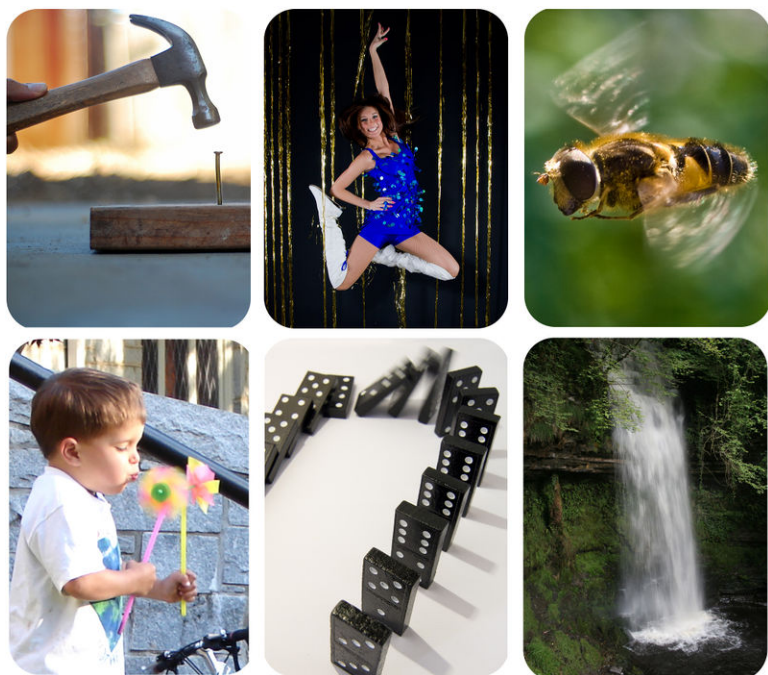

FIGURE 17.3

All of these photos show things that have kinetic energy because they are moving.

greater velocity has more kinetic energy. The kinetic energy of a moving object can be calculated with the equation:

$$\text{Kinetic Energy (KE)} = \frac{1}{2} \text{mass} \times \text{velocity}^2$$

This equation for kinetic energy shows that velocity affects kinetic energy more than mass does. For example, if mass doubles, kinetic energy also doubles. But if velocity doubles, kinetic energy increases by a factor of four. That's because velocity is squared in the equation. You can see for yourself how mass and velocity affect kinetic energy by working through the problems below.

Problem Solving

Problem: Juan has a mass of 50 kg. If he is running at a velocity of 2 m/s, how much kinetic energy does he have?

Solution: Use the formula: $\text{KE} = \frac{1}{2} \text{mass} \times \text{velocity}^2$

$$\begin{aligned} \text{KE} &= \frac{1}{2} \times 50 \text{ kg} \times (2 \text{ m/s})^2 \\ &= 100 \text{ kg} \cdot \text{m}^2/\text{s}^2 = 100 \text{ N} \cdot \text{m}, \text{ or } 100 \text{ J} \end{aligned}$$

You Try It!

Problem: What is Juan's kinetic energy if he runs at a velocity of 4 m/s?

Problem: Juan's dad has a mass of 100 kg. How much kinetic energy does he have if he runs at a velocity of 2 m/s?

Potential Energy

Did you ever see a scene like the one in **Figure 17.4**? In many parts of the world, trees lose their leaves in autumn. The leaves turn color and then fall from the trees to the ground. As the leaves are falling, they have kinetic energy. While they are still attached to the trees they also have energy, but it's not because of motion. Instead, they have stored energy, called **potential energy**. An object has potential energy because of its position or shape. For example leaves on trees have potential energy because they could fall due to the pull of gravity.

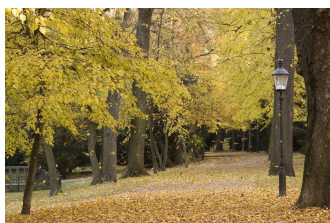

FIGURE 17.4

Before leaves fall from trees in autumn, they have potential energy. Why do they have the potential to fall?

Gravitational Potential Energy

Potential energy due to the position of an object above Earth is called gravitational potential energy. Like the leaves on trees, anything that is raised up above Earth's surface has the potential to fall because of gravity. You can see examples of people with gravitational potential energy in **Figure 17.5**.



FIGURE 17.5

All three of these people have gravitational potential energy. Can you think of other examples?

Gravitational potential energy depends on an object's weight and its height above the ground. It can be calculated with the equation:

$$\text{Gravitational potential energy (GPE)} = \text{weight} \times \text{height}$$

Consider the diver in **Figure 17.5**. If he weighs 70 newtons and the diving board is 5 meters above Earth's surface, then his potential energy is:

$$\text{GPE} = 70 \text{ N} \times 5 \text{ m} = 350 \text{ N} \cdot \text{m}, \text{ or } 350 \text{ J}$$

You Try It!

Problem: Kris is holding a 2-kg book 1.5 m above the floor. What is the gravitational potential energy of the book?

Elastic Potential Energy

Potential energy due to an object's shape is called elastic potential energy. This energy results when elastic objects are stretched or compressed. Their elasticity gives them the potential to return to their original shape. For example, the rubber band in **Figure 17.6** has been stretched, but it will spring back to its original shape when released. Springs like the handspring in the figure have elastic potential energy when they are compressed. What will happen when the handspring is released?

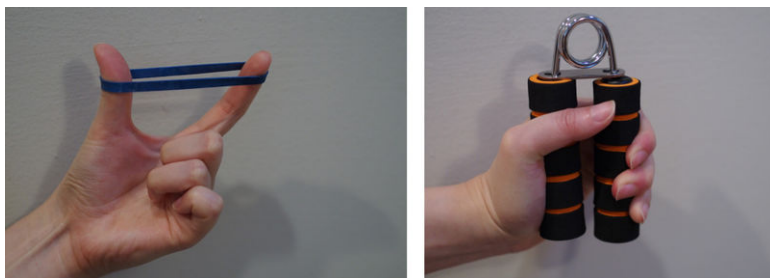
**FIGURE 17.6**

Changing the shape of an elastic material gives it potential energy.

Energy Conversion

Remember the diver in **Figure 17.5**? What happens when he jumps off the diving board? His gravitational potential energy changes to kinetic energy as he falls toward the water. However, he can regain his potential energy by getting out of the water and climbing back up to the diving board. This requires an input of kinetic energy. These changes in energy are examples of **energy conversion**, the process in which energy changes from one type or form to another.

Conservation of Energy

The law of conservation of energy applies to energy conversions. Energy is not used up when it changes form, although some energy may be used to overcome friction, and this energy is usually given off as heat. For example, the diver's kinetic energy at the bottom of his fall is the same as his potential energy when he was on the diving board, except for a small amount of heat resulting from friction with the air as he falls.

Examples of Energy Conversions

There are many other examples of energy conversions between potential and kinetic energy. **Figure 17.7** describes how potential energy changes to kinetic energy and back again on swings and trampolines. You can see an animation of changes between potential and kinetic energy on a ramp at the URL below. Can you think of other examples?

<http://www.physicsclassroom.com/mmedia/energy/ie.cfm>



On a swing, gravity gives the swinger the greatest potential energy where the swing is highest above the ground and the least potential energy where the swing is closest to the ground. Where does the swinger have kinetic energy? (Hint: When is the swinger moving?)

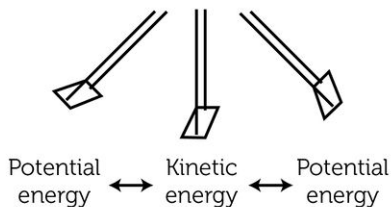

On a trampoline, gravity gives the jumper potential energy at the top of each jump. Elasticity of the trampoline gives the jumper potential energy at the bottom of each jump. Where does the jumper have kinetic energy?

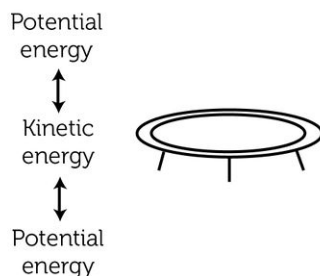

FIGURE 17.7

Energy continuously changes back and forth between potential and kinetic energy on a swing or trampoline.

Lesson Summary

- Energy is the ability to do work. When work is done, energy is transferred from one object to another. Energy can exist in different forms, such as electrical and chemical energy. Most forms of energy can also be classified as kinetic or potential energy.
- Kinetic energy is the energy of moving matter. Things with kinetic energy can do work. Kinetic energy depends on an object's mass and velocity.
- Potential energy is the energy stored in an object because of its position or shape. It includes gravitational potential energy and elastic potential energy. Gravitational potential energy depends on an object's weight and height above the ground.
- Energy conversion occurs when energy changes from one type or form of energy to another. Energy often changes between potential and kinetic energy. Energy is always conserved during energy conversions.

Lesson Review Questions

Recall

1. Define kinetic energy and give an example.

2. What is potential energy?
3. Describe how energy changes on a swing.

Apply Concepts

4. Explain how energy changes in the spring toy below when it goes down stairs.



Think Critically

5. How is energy related to work?
6. Compare and contrast gravitational potential energy and elastic potential energy.

Points to Consider

The examples of kinetic and potential energy you read about in this lesson are types of mechanical energy. Mechanical energy is one of several forms of energy you can read about in the next lesson, "Forms of Energy."

- Based on the examples in this lesson, how would you define mechanical energy?
- What might be other examples of mechanical energy?

17.2 Forms of Energy

Lesson Objectives

- Identify different forms of energy.
- Describe how energy changes form.

Lesson Vocabulary

- chemical energy
- electrical energy
- electromagnetic energy
- mechanical energy
- sound energy
- thermal energy

Introduction

The young man in **Figure 17.8** is playing an electric guitar in a rock concert. He plucks the strings of the guitar with skill, and the sounds of the music thrill the crowd. The bright stage lights in the otherwise dark concert hall add to the excitement, although they make it hot on stage. This scene represents energy in several different forms. Do you know what they are? You'll find out in this lesson.



FIGURE 17.8

How many different forms of energy can you identify in this picture?

Comparing Forms of Energy

Energy, or the ability to do work, can exist in many different forms. The photo in **Figure 17.8** represents six of the eight different forms of energy that are described in this lesson. The guitarist gets the energy he needs to perform from chemical energy in food. He uses mechanical energy to pluck the strings of the guitar. The stage lights use electrical energy and give off both light energy and thermal energy, commonly called heat. The guitar also uses electrical energy, and it produces sound energy when the guitarist plucks the strings. For an introduction to all these forms of energy, go to this URL: <http://www.need.org/needpdf/FormsofEnergy.pdf> .

For an interactive animation about the different forms of energy, visit this URL: <http://www.explorelearning.com/index.cfm?method=cResource.dspView&ResourceID=651> .

After you read below about different forms of energy, you can check your knowledge by doing the drag and drop quiz at this URL: <http://www.think-energy.co.uk/ThinkEnergy/11-14/activities/TypesEnergy.aspx> .

Mechanical Energy

Mechanical energy is the energy of an object that is moving or has the potential to move. It is the sum of an object's kinetic and potential energy. In **Figure 17.9**, the basketball has mechanical energy because it is moving. The arrow in the same figure has mechanical energy because it has the potential to move due to the elasticity of the bow. What are some other examples of mechanical energy?



FIGURE 17.9

Kinetic and potential energy add up to mechanical energy.

Energy associated with the movement and potential movement of objects is called mechanical energy.

Chemical Energy

Energy is stored in the bonds between atoms that make up compounds. This energy is called **chemical energy**, and it is a form of potential energy. If the bonds between atoms are broken, the energy is released and can do work. The wood in the fireplace in **Figure 17.10** has chemical energy. The energy is released as thermal energy when the wood burns. People and many other living things meet their energy needs with chemical energy stored in food. When food molecules are broken down, the energy is released and may be used to do work.

**FIGURE 17.10**

Chemical energy is stored in wood and released when the wood burns.

Electrical Energy

Electrons are negatively charged particles in atoms. Moving electrons have a form of kinetic energy called **electrical energy**. If you've ever experienced an electric outage, then you know how hard it is to get by without electrical energy. Most of the electrical energy we use is produced by power plants and arrives in our homes through wires. Two other sources of electrical energy are pictured in **Figure 17.11**.



An average lightning bolt has about 500 million joules of electrical energy!



Over its lifetime, an AA battery may provide about 9000 joules of electrical energy.

FIGURE 17.11

A lightning bolt is a powerful discharge of electrical energy. A battery contains stored chemical energy and converts it to electrical energy.

Nuclear Energy

The nuclei of atoms are held together by powerful forces. This gives them a tremendous amount of stored energy, called nuclear energy. The energy can be released and used to do work. This happens in nuclear power plants when nuclei fission, or split apart. It also happens in the sun and other stars when nuclei fuse, or join together. Some of the sun's energy travels to Earth, where it warms the planet and provides the energy for photosynthesis (see **Figure 17.12**).

Thermal Energy

The atoms that make up matter are in constant motion, so they have kinetic energy. All that motion gives matter thermal energy. **Thermal energy** is defined as the total kinetic energy of all the atoms that make up an object. It

**FIGURE 17.12**

In the sun, hydrogen nuclei fuse to form helium nuclei. This releases a huge amount of energy, some of which reaches Earth.

depends on how fast the atoms are moving and how many atoms the object has. Therefore, an object with more mass has greater thermal energy than an object with less mass, even if their individual atoms are moving at the same speed. You can see an example of this in **Figure 17.13**.

**FIGURE 17.13**

Atoms are moving at the same speed in the soup on the spoon as they are in the soup in the pot. However, there are more atoms of soup in the pot, so it has more thermal energy.

Electromagnetic Energy

Energy that the sun and other stars release into space is called **electromagnetic energy**. This form of energy travels through space as electrical and magnetic waves. Electromagnetic energy is commonly called light. It includes visible light, as well as radio waves, microwaves, and X rays (**Figure 17.14**).



A radio tower (left) sends radio waves through the air. Radios in the area can pick up the energy and convert it to sound.

A microwave oven (above right) sends microwaves through food, causing it to cook quickly.

An X-ray machine sends out X rays that pass through soft tissues such as skin but not through hard tissues such as teeth. The X rays create an image on film (bottom right).

FIGURE 17.14

Radio waves, microwaves, and X rays are examples of electromagnetic energy.

Sound Energy

The drummer in **Figure 17.15** is hitting the drumheads with drumsticks. This causes the drumheads to vibrate. The vibrations pass to surrounding air particles and then from one air particle to another in a wave of energy called **sound energy**. We hear sound when the sound waves reach our ears. Sound energy can travel through air, water, and other substances, but not through empty space. That's because the energy needs particles of matter to pass it on.



FIGURE 17.15

Vibrating objects such as drumheads produce sound energy.

How Energy Changes Form

Energy often changes from one form to another. For example, the mechanical energy of a moving drumstick changes to sound energy when it strikes the drumhead and causes it to vibrate. Any form of energy can change into any other form. Frequently, one form of energy changes into two or more different forms. For example, when wood burns, the wood's chemical energy changes to both thermal energy and light energy. Other examples of energy conversions are described in **Figure 17.16**. You can see still others at this URL: <http://fi.edu/guide/hughes/energychangeex.html> .

You can check your understanding of how energy changes form by doing the quizzes at these URLs:

- <http://www.think-energy.co.uk/ThinkEnergy/11-14/activities/EnergyTrans2.aspx>
- <http://www.poweringourfuture.com/students/energy/2.html>

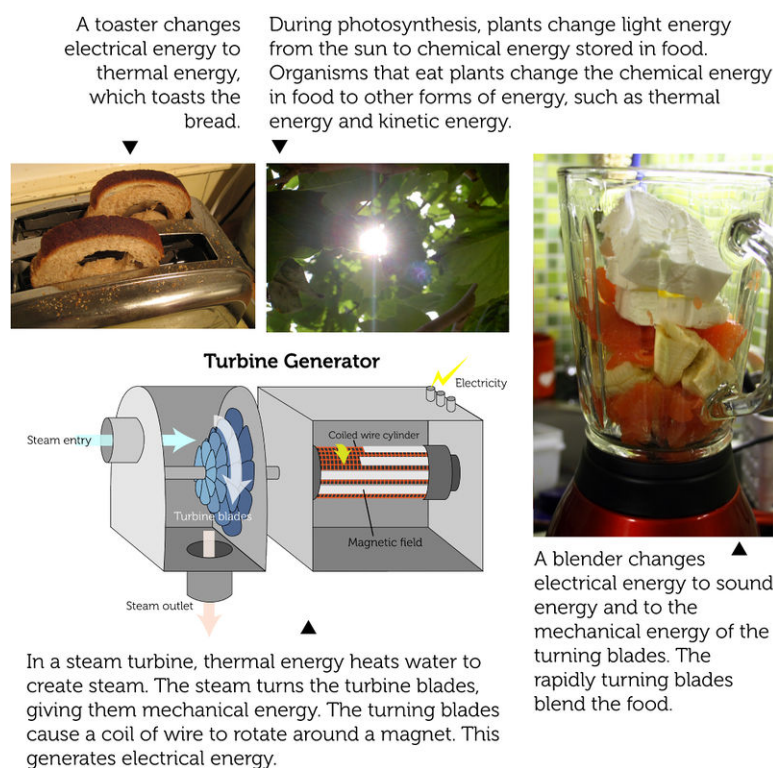

FIGURE 17.16

Energy is constantly changing form. Can you think of other examples of energy conversions?

Energy is conserved in energy conversions. No energy is lost when energy changes form, although some may be released as thermal energy due to friction. For example, not all of the energy put into a steam turbine in **Figure 17.16** changes to electrical energy. Some changes to thermal energy because of friction of the turning blades and other moving parts. The more efficient a device is, the greater the percentage of usable energy it produces. Appliances with an "Energy Star" label like the one in **Figure 17.17** use energy efficiently and thereby reduce energy use.

Lesson Summary

- Forms of energy include mechanical, chemical, electrical, nuclear, thermal, electromagnetic, and sound energy. These forms of energy can occur as either kinetic or potential energy.

**FIGURE 17.17**

The U.S. government's Energy Star program certifies the energy efficiency of appliances. Look for this label to identify those that are energy efficient.

- Energy often changes from one form to another. Any form of energy can change into any other, and one form may change into two or more different forms. Energy is always conserved when it changes form.

Lesson Review Questions

Recall

1. Define mechanical energy.
2. Give an example of chemical energy.
3. What is electrical energy?
4. Name two processes that release nuclear energy.
5. List three types of electromagnetic energy.

Apply Concepts

6. If you were on the moon, no sound energy would be able to reach your ears. Explain why. (*Hint:* The moon has no atmosphere.)
7. State how energy is converted by the following electrical devices: light bulb, alarm clock, hair dryer.

Think Critically

8. Relate the thermal energy of an object to the object's atoms.

Points to Consider

In this lesson, you read about electrical appliances that convert electrical energy to other forms of energy, such as thermal energy or sound energy.

- What form of energy is converted to electrical energy when electric current is generated?
- What natural resources might provide the energy needed to generate electricity?

17.3 Energy Resources

Lesson Objectives

- Describe nonrenewable energy resources.
- Identify several renewable energy resources.
- Outline world energy use and ways to conserve energy.

Lesson Vocabulary

- conservation
- fossil fuel
- natural resource
- nonrenewable resource
- renewable resource

Introduction

Did you ever go whitewater rafting, like the people in **Figure 17.18**? What an exciting ride! The churning water tosses the raft and drenches its riders with spray and foam. Water is a great place to have fun, whether you are rafting, swimming, snorkeling, jet skiing, or fishing. In fact, water is one of our most precious natural resources. A **natural resource** is anything people can use that comes from nature. In this lesson, you'll learn how we use water—and many other natural resources—for energy. For a brief overview of the energy resources you'll learn about in this lesson, go to this URL: <http://www.think-energy.co.uk/ThinkEnergy/11-14/activities/EnergyTrans.aspx> .

For a cartoon introduction to energy resources, go to this URL: http://www.youtube.com/watch?v=RD_54Cq_UMM (1:39).

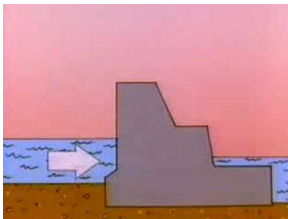

MEDIA

Click image to the left for more content.

Nonrenewable Energy Resources

Nonrenewable resources are natural resources that are limited in supply and cannot be replaced except over millions

**FIGURE 17.18**

Whitewater rafting is an exciting sport.

of years. Nonrenewable energy resources include fossil fuels and radioactive elements such as uranium.

Fossil Fuels

Fossil fuels are mixtures of hydrocarbons that formed over millions of years from the remains of dead organisms. They include petroleum (commonly called oil), natural gas, and coal. Fossil fuels provide most of the energy used in the world today. They are burned in power plants to produce electrical energy, and they also fuel cars, heat homes, and supply energy for many other purposes. You can see examples of their use in **Figure 17.19**.



Natural gas burns with a blue flame in this gas stove. Many homes also have natural gas water heaters and furnaces. Some motor vehicles burn natural gas as well.



Petroleum is used to make gasoline, which fuels most motor vehicles. It is also used to make heating oil for furnaces and kerosene for camp stoves.



The majority of electric power in the U.S. is generated by burning coal in power plants like this one.

FIGURE 17.19

Do you use any of these fossil fuels? How do you use them?

Fossil fuels contain stored chemical energy that came originally from the sun. Ancient plants changed energy in

sunlight to stored chemical energy in food, which was eaten by other organisms. After the plants and other organisms died, their remains gradually changed to fossil fuels as they were pressed beneath layers of sediments. Petroleum and natural gas formed from marine organisms and are often found together. Coal formed from giant tree ferns and other swamp plants.

When fossil fuels burn, they release thermal energy, water vapor, and carbon dioxide. Carbon dioxide produced by fossil fuel use is a major cause of global warming. The burning of fossil fuels also releases many pollutants into the air. Pollutants such as sulfur dioxide form acid rain, which kills living things and damages metals, stonework, and other materials. Pollutants such as nitrogen oxides cause smog, which is harmful to human health. Tiny particles, or particulates, released when fossil fuels burn also harm human health. Natural gas releases the least pollution; coal releases the most (see **Figure 17.20**). Petroleum has the additional risk of oil spills, which may seriously damage ecosystems.

Fossil Fuel Pollution Levels

Pounds per Billion Units of Energy

Pollutant	Natural Gas	Oil	Coal
Carbon Dioxide	117,000	164,000	208,000
Carbon Monoxide	40	33	208
Nitrogen Oxides	92	448	457
Sulfur Dioxide	1	1,122	2,591
Particulates	7	84	2,744
Mercury	0	0.007	0.016

FIGURE 17.20

This table compares the levels of several air pollutants released by the burning of natural gas, oil, and coal.

Nuclear Energy

Like fossil fuels, the radioactive element uranium can be used to generate electrical energy in power plants. In a nuclear power plant, the nuclei of uranium atoms are split in the process of nuclear fission. This process releases a tremendous amount of energy from just a small amount of uranium. The total supply of uranium in the world is quite limited, however, and cannot be replaced once it is used up. This makes nuclear energy a nonrenewable resource. Although using nuclear energy does not release carbon dioxide or cause air pollution, it does produce dangerous radioactive wastes. Accidents at nuclear power plants also have the potential to release large amounts of radioactive material into the environment. **Figure 17.21** describes the nuclear disaster caused by a Japanese tsunami in 2011. You can learn more about the disaster and its aftermath at the URLs below.

- <http://www.bbc.co.uk/news/world-asia-pacific-12711226>
- <http://www.bbc.co.uk/news/world-asia-pacific-12731781>
- <http://www.bbc.co.uk/news/world-asia-pacific-12726591>

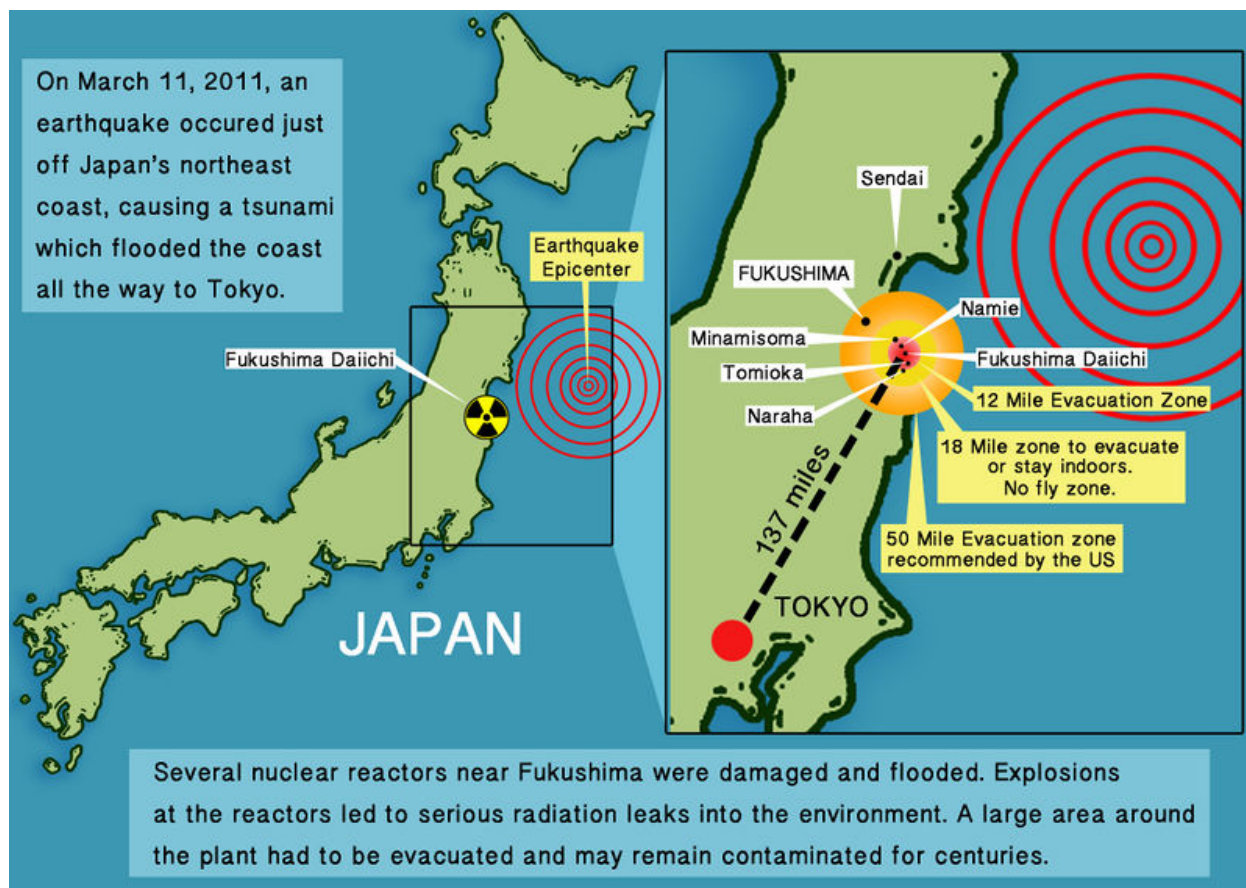

FIGURE 17.21

Do you remember Japan's 2011 nuclear disaster? (Note: the map on the right is not to scale.)

Renewable Energy Resources

Renewable resources are natural resources that can be replaced in a relatively short period of time or are virtually limitless in supply. Renewable energy resources include sunlight, moving water, wind, biomass, and geothermal energy. Each of these energy resources is described in **Table 17.1**. Resources such as sunlight and wind are limitless in supply, so they will never run out. Besides their availability, renewable energy resources also have the advantage of producing little if any pollution and not contributing to global warming. The technology needed to gather energy from renewable resources is currently expensive to install, but most of the resources themselves are free for the taking.

TABLE 17.1: What are the pros and cons of using each of the renewable energy resources described here?

Renewable Energy Resource	Example
---------------------------	---------

TABLE 17.1: (continued)





Renewable Energy Resource	Example
<p>Sunlight</p> <p>The energy in sunlight, or solar energy, can be used to heat homes. It can also be used to produce electricity in solar cells. However, solar energy may not be practical in areas that are often cloudy.</p>	 <p>Solar panels on the roof of this house generate enough electricity to supply a family's needs.</p>
<p>Moving Water</p> <p>When water falls downhill, its potential energy is converted to kinetic energy that can turn a turbine and generate electricity. The water may fall naturally over a waterfall or flow through a dam. A drawback of dams is that they flood land upstream and reduce water flow downstream. Either effect may harm ecosystems.</p>	 <p>Water flowing through Hoover dam between Arizona and Nevada generates electricity for both of these states and also by southern California. The dam spans the Colorado River.</p>
<p>Wind</p> <p>Wind is moving air, so it has kinetic energy that can do work. Remember the wind turbines that opened this chapter? Wind turbines change the kinetic energy of the wind to electrical energy. Only certain areas of the world get enough steady wind to produce much electricity. Many people also think that wind turbines are noisy and unattractive in the landscape.</p>	 <p>This old-fashioned windmill captures wind energy that is used for pumping water out of a well. Windmills like this one have been used for centuries.</p>
<p>Biomass</p> <p>The stored chemical energy of trees and other plants is called biomass energy. When plant materials are burned, they produce thermal energy that can be used for heating, cooking, or generating electricity. Biomass—especially wood—is an important energy source in countries where most people can't afford fossil fuels. Some plants can also be used to make ethanol, a fuel that is added to gasoline. Ethanol produces less pollution than gasoline, but large areas of land are needed to grow the plants needed to make it.</p>	 <p>This large machine is harvesting and grinding plants to be used for biomass energy.</p>

TABLE 17.1: (continued)

Renewable Energy Resource	Example
<p>Geothermal Heat below Earth’s surface—called geothermal energy—can be used to produce electricity. A power plant pumps water underground where it is heated. Then it pumps the water back to the plant and uses its thermal energy to generate electricity. On a small scale, geothermal energy can be used to heat homes. Installing a geothermal system can be very costly, however, because of the need to drill through underground rocks.</p>	 <p>This geothermal power plant is located in Italy where hot magma is close to the surface.</p>

Energy Use and Conservation

Figure 17.22 shows the mix of energy resources used worldwide in 2006. Fossil fuels still provide most of the world’s energy, with oil being the single most commonly used energy resource. Natural gas is used less than the other two fossil fuels, but even natural gas is used more than all renewable energy resources combined. Wind, solar, and geothermal energy contribute the least to global energy use, despite the fact that they are virtually limitless in supply and nonpolluting.

Global Energy Resources (2006)

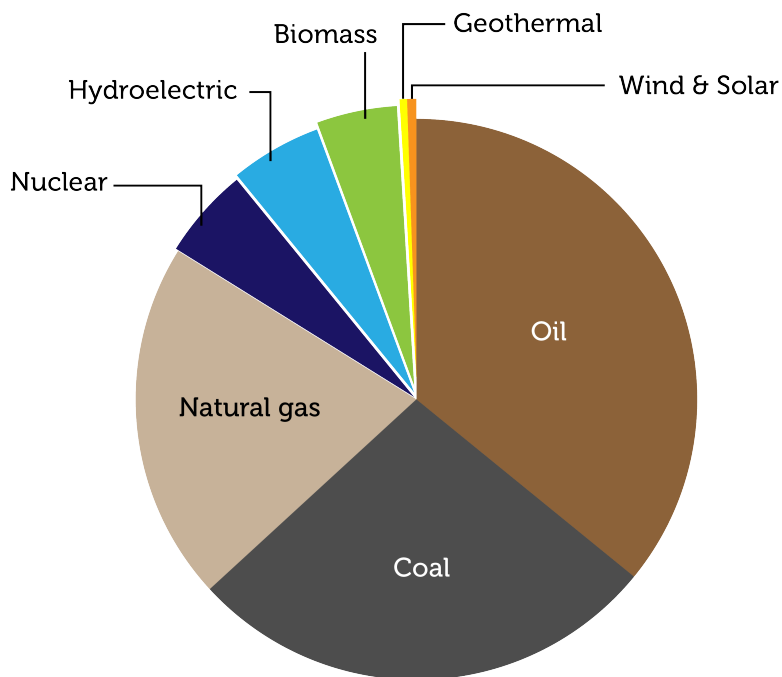

FIGURE 17.22

Which of the energy resources in this circle graph are renewable?

Energy Use by Nation

People in the richer nations of the world use far more energy, especially energy from fossil fuels, than people in the poorer nations do. **Figure 17.23** compares the amounts of oil used by the top ten oil-consuming nations. The U.S. uses more oil than several other top-ten countries combined. If you also consider the population size in these countries, the differences are even more stunning. The average person in the U.S. uses a whopping 23 barrels of oil a year! In comparison, the average person in India or China uses just 1 or 2 barrels a year. Because richer nations use more fossil fuels, they also cause more air pollution and global warming than poorer nations do.

Oil Use (Barrels per Day) in the Top Ten Oil-Consuming Nations

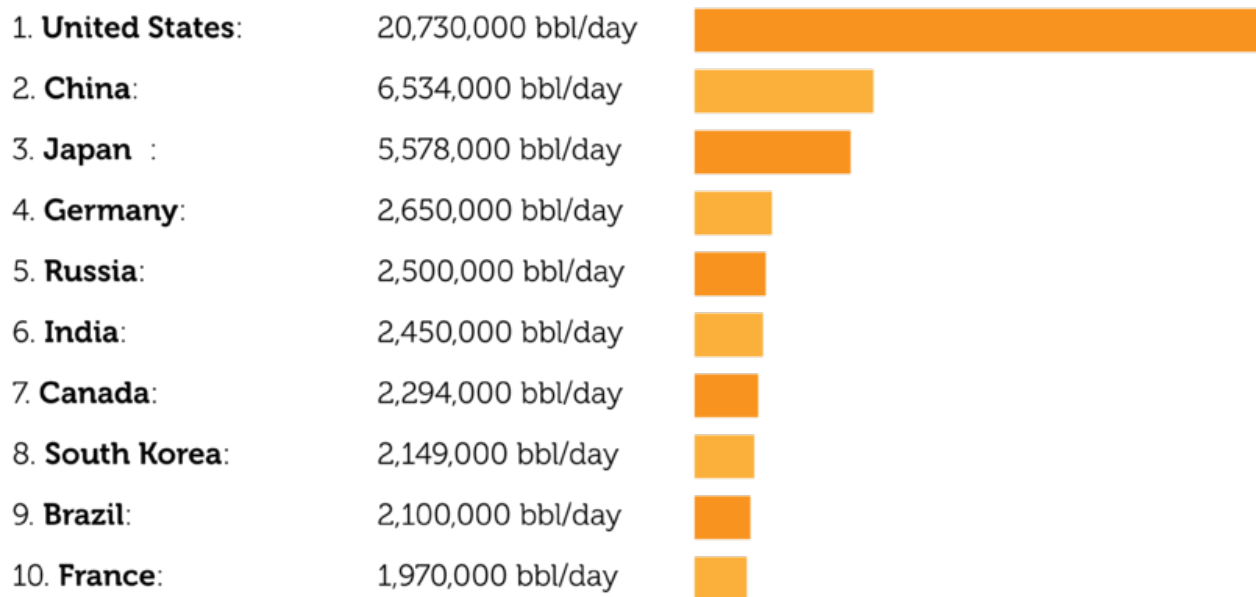

FIGURE 17.23

The U.S. uses far more oil than any other country in the world. It is even far ahead of the next largest oil user, which is China. The differences in use per person in these countries are even greater.

Conserving Energy

We can reduce our use of energy resources and the pollution they cause by conserving energy. **Conservation** means saving resources by using them more efficiently or not using them at all. **Figure 17.24** shows several ways that people can conserve energy in their daily lives. You can find more energy-saving tips at the URL below. What do you do to save energy? What else could you do?

<http://www.partselect.ca/resources/Home-Energy-Saving-Tips.aspx>



When people ride the subway, there are fewer cars on the road.

Much of the oil used in the U.S. is used for transportation. You can conserve energy by:

- Planning ahead to avoid unnecessary trips
- Carpooling, walking, or taking public transit instead of driving
- Driving an energy-efficient vehicle



Many people waste energy at home. You can conserve energy by:

- Turning off lights and appliances when not in use
- Buying energy-efficient light bulbs and appliances
- Turning the thermostat down in winter and up in summer

Turning off lights when you leave a room saves money as well as energy.

FIGURE 17.24

Small savings in energy really add up when everybody conserves energy.

Lesson Summary

- Nonrenewable resources are natural resources that are limited in supply and cannot be replaced except over millions of years. They also release pollutants and contribute to global climate change. Nonrenewable energy resources include fossil fuels, which are burned, and uranium, which is used for nuclear fission.
- Renewable resources are natural resources that can be replaced in a relatively short period of time or are virtually limitless in supply. They cause little if any pollution or global climate change. Renewable energy resources include sunlight, moving water, wind, biomass, and geothermal energy.
- Fossil fuels provide most of the energy used worldwide. Richer nations use far more energy resources, especially fossil fuels, than poorer nations do. There are several ways that people can conserve energy in their daily lives.

Lesson Review Questions

Recall

1. What is a natural resource?
2. Identify three fossil fuels.
3. Describe how fossil fuels form.
4. What are drawbacks of using fossil fuels?
5. State why nuclear energy is a nonrenewable resource.

Apply Concepts

6. Create a Web page or poster that encourages people to conserve energy and gives tips for how to do it.

Think Critically

7. Compare and contrast nonrenewable and renewable energy resources.
8. Argue for the use of any two renewable energy resources.

Points to Consider

In this chapter, you read that energy is transferred when work is done. You also read about thermal energy.

- You can use the thermal energy of a stove to cook food. How is thermal energy transferred from the hot stovetop to a pot on the stove?
- You can feel the thermal energy of a campfire, even when you are sitting a few feet away. How does thermal energy travel through the air from the fire to you?

For **Table 17.1**,

- Solar panel: Jon Callas. <http://www.flickr.com/photos/joncallas/5586087273/> . CC BY 2.0.
- Dam: Flickr:NatureClip. <http://www.flickr.com/photos/natureclip/9764092224/> . CC BY 2.0.
- Windmill: Fuzzy Gerdes. <http://www.flickr.com/photos/fuzzy/3772169287/> . CC BY 2.0.
- Biomass: Image courtesy of Idaho National Laboratory (INL) Bioenergy Program (www.inl.gov/bioenergy). <http://www.flickr.com/photos/inl/7896779532/> . CC BY 2.0.
- Geothermal plant: Birgit Juel Martinsen. <http://www.flickr.com/photos/martinsen-jordenrundt/5437266214/> . CC BY 2.0.

17.4 References

1. Angus Chan (Flickr:gusmaru). <http://www.flickr.com/photos/59376848@N08/9326861459/> . CC BY 2.0
2. Flickr:MyBiggestFan. <http://www.flickr.com/photos/msciba/210081711/> . CC BY 2.0
3. Hammer and nail: Robert Lopez; Jumping girl: Johan Viirok; Bees: William Warby; Boy and pinwheel: Flickr:popofatticus; Dominoes: Barry Skeates; Waterfall: Tony Hisgett. Hammer and nail: CK-12 Foundation; Jumping girl: <http://www.flickr.com/photos/viirok/5287805940/>; Bees: <http://www.flickr.com/photos/warby/2990091410/>; Boy and pinwheel: <http://www.flickr.com/photos/barretthall/3470428667/>; Dominoes: <http://www.flickr.com/photos/barryskeates/6803422544/>; Waterfall: <http://www.flickr.com/photos/hisgett/422399097/> . Hammer and nail: CC BY-NC 3.0; Rest: CC BY 2.0
4. Flickr:unukorno. <http://www.flickr.com/photos/unukorno/4089424778/> . CC BY 2.0
5. Diving: Daniel Lewis (Flickr:rattler97); Upside down girl: Flickr:DieselDemon; Skateboarder: Flickr:thefixer. Diving: <http://www.flickr.com/photos/rattler97/5932298946/>; Upside down girl: <http://www.flickr.com/photos/28096801@N05/3647910820/>; Skateboarder: <http://www.flickr.com/photos/fixersphotos/3379770368/> . CC BY 2.0
6. Joy Sheng. CK-12 Foundation . CC BY-NC 3.0
7. Swing: Flickr:wsilver; Trampoline: Flickr:London looks. Swing: <http://www.flickr.com/photos/psycho-pics/2722836221/>; Trampoline: <http://www.flickr.com/photos/londonlooks/6204272401/> . CC BY 2.0
8. David Burke (Flickr:Orangedrummaboy). http://www.flickr.com/photos/cit_thmc/7219683088/ . CC BY 2.0
9. Basketball: Flickr:J R; Archery: Camp Pinewood. Basketball: <http://www.flickr.com/photos/jmrosenfeld/3187299358/>; Archery <http://www.flickr.com/photos/camppinewood/9293493292/> . CC BY 2.0
10. Graeme Maclean (Flickr:_gee_). <http://www.flickr.com/photos/gee01/153279685/> . CC BY 2.0
11. Lightning: Flickr:j_arred; Battery: Wilson Hui. Lightning: <http://www.flickr.com/photos/30395273@N02/6074735344/>; Battery: <http://www.flickr.com/photos/wilsonhui/9572040621/> . CC BY 2.0
12. Courtesy of NASA. http://commons.wikimedia.org/wiki/File:Full_Sunburst_over_Earth.JPG . Public Domain
13. Joe Hall (Flickr:joebeone). <http://www.flickr.com/photos/joebeone/2118482785/> . CC By 2.0
14. Radio tower: Mark Seymour; Microwave: Flickr:osseous; X ray: Paulo Ordoveza (Flickr:brownpau). Radio tower: <http://www.flickr.com/photos/markseymour/5603632489/>; Microwave: <http://www.flickr.com/photos/osseous/7163044412/>; X ray: <http://www.flickr.com/photos/brownpau/4879544448/> . CC BY 2.0
15. Roger Blackwell. <http://www.flickr.com/photos/rogerblackwell/10382353533/> . CC BY 2.0
16. Toaster: Kai Hendry ; Sun through leaves: Keith Hall; Blender: Antti T. Nissinen (Flickr:V31S70); Turbine generator: Christopher Auyeung. Toaster: <http://www.flickr.com/photos/hendry/964163684/>; Sun through leaves: http://www.flickr.com/photos/fire_brace/30679655/; Blender: <http://www.flickr.com/photos/veisto/342942175/>; Turbine generator: CK-12 Foundation . Toaster: CC BY 2.0; Sun through leaves: CC BY 2.0; Blender: CC BY 2.0; Turbine generator: CC BY-NC 3.0
17. Courtesy of U.S. EPA and U.S. DOE. <http://www.energystar.gov/index.cfm?fuseaction=globalwarming.showIdentifiers> . Public Domain
18. Rob Chandler (Flickr:Rob Jules). http://commons.wikimedia.org/wiki/File:White_water_rafting,_Rangitapu_Valley,_NZ.jpg . CC BY 2.0
19. Natural gas: Paul Kretek (Flickr:pa*kr); Pumping gas: futureatlas.com; Plant: Kid Cluth (Flickr:Graf Spee). Natural gas: <http://www.flickr.com/photos/limemonkey/486575859/>; Pumping gas: <http://www.flickr.com/photos/87913776@N00/460375914/>; Plant: <http://www.flickr.com/photos/30901506@N06/7912828370/> . CC BY 2.0
20. Christopher Auyeung, source: EIA - Natural Gas Issues and Trends. CK-12 Foundation . CC BY-NC 3.0
21. Laura Guerin. CK-12 Foundation . CC BY-NC 3.0
22. Christopher Auyeung. CK-12 Foundation . CC BY-NC 3.0

23. Christopher Auyeung. [CK-12 Foundation](#) . CC BY-NC 3.0
24. Subway: Metropolitan Transportation Authority of the State of New York; Light switch: wilB (Flickr:idea ablaze). [Subway: http://www.flickr.com/photos/mtaphotos/8879516489/](http://www.flickr.com/photos/mtaphotos/8879516489/); [Light switch: http://www.flickr.com/photos/ideaablaze/4932631175/](http://www.flickr.com/photos/ideaablaze/4932631175/) . CC BY 2.0

CHAPTER 18**Thermal Energy****Chapter Outline**

- 18.1 TEMPERATURE AND HEAT**
 - 18.2 TRANSFER OF THERMAL ENERGY**
 - 18.3 USING THERMAL ENERGY**
 - 18.4 REFERENCES**
-



Death Valley, California, pictured here, is one of the hottest places on Earth. The temperature of the air near the ground can be as high as 57°C (134°F)—and that’s in the shade! The temperature of the sand in the baking sun can be much higher. If you were to walk barefoot on the hot sand, it would burn your feet. How does energy from the sun heat the sand? What causes the sand’s temperature to rise? And what exactly does temperature measure? Think about these questions as you read about thermal energy in this chapter.

William Warby. www.flickr.com/photos/wwarby/9641689318/. CC BY 2.0.

18.1 Temperature and Heat

Lesson Objectives

- Explain the relationship between temperature and thermal energy.
- Define heat and specific heat.

Lesson Vocabulary

- heat
- specific heat

Introduction

The hot air and sand in Death Valley have a lot of thermal energy, or the kinetic energy of moving particles. But even cold objects have some thermal energy. That's because the particles of all matter are in constant random motion. If cold as well as hot objects have moving particles, what, if anything, does temperature have to do with thermal energy?

Temperature

No doubt you already have a good idea of what temperature is. You might define it as how hot or cold something feels. In physics, temperature is defined as the average kinetic energy of the particles in an object. When particles move more quickly, temperature is higher and an object feels warmer. When particles move more slowly, temperature is lower and an object feels cooler.

Temperature and Thermal Energy

If two objects have the same mass, the object with the higher temperature has greater thermal energy. Temperature affects thermal energy, but temperature isn't the same thing as thermal energy. That's because an object's mass also affects its thermal energy. The examples in **Figure 18.1** make this clear. In the figure, the particles of cocoa are moving faster than the particles of bathwater. Therefore, the cocoa has a higher temperature. However, the bath water has more thermal energy because there is so much more of it. It has many more moving particles. Bill Nye the Science Guy cleverly discusses these concepts at this URL: <http://www.youtube.com/watch?v=f1eAOygDP5s&feature=related> (2:06).



MEDIA

Click image to the left for more content.

If you're still not clear about the relationship between temperature and thermal energy, watch the animation "Temperature" at this URL: <http://www.sciencehelpdesk.com/unit/science2/3> .

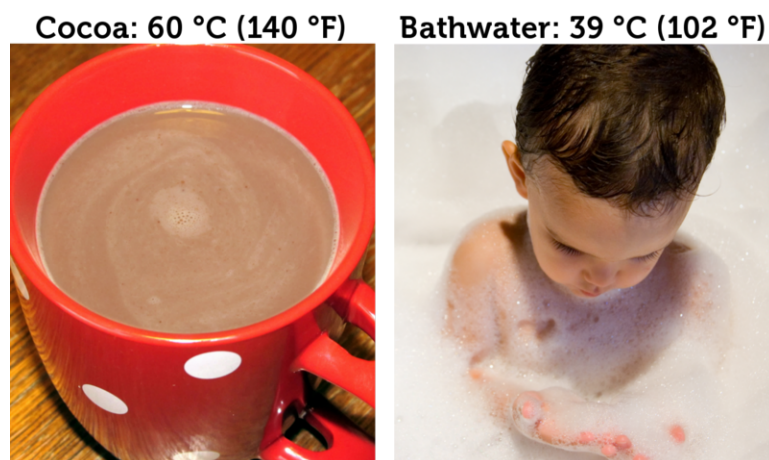

FIGURE 18.1

The cocoa is scalding hot. The bath water is comfortably warm. Why does the bath water have more thermal energy than the cocoa?

Measuring Temperature

Temperature is measured with a thermometer. A thermometer shows how hot or cold something is relative to two reference temperatures, usually the freezing and boiling points of water. Scientists often use the Celsius scale for temperature. On this scale, the freezing point of water is 0°C and the boiling point is 100°C. To learn more about measuring temperature, watch the animation "Measuring Temperature" at this URL: <http://www.sciencehelpdesk.com/unit/science2/3> .

Did you ever wonder how a thermometer works? Look at the thermometer in **Figure 18.2**. Particles of the red liquid have greater energy when they are warmer, so they move more and spread apart. This causes the liquid to expand and rise higher in the glass tube. Like the liquid in a thermometer, most types of matter expand to some degree when they get warmer. Gases usually expand the most when heated, followed by liquids. Solids generally expand the least. (Water is an exception; it takes up more space as a solid than as a liquid.)

Heat

Something that has a high temperature is said to be hot. Does temperature measure heat? Is heat just another word for thermal energy? The answer to both questions is no. **Heat** is the transfer of thermal energy between objects that have different temperatures. Thermal energy always moves from an object with a higher temperature to an object with a lower temperature. When thermal energy is transferred in this way, the warm object becomes cooler and the cool object becomes warmer. Sooner or later, both objects will have the same temperature. Only then does the transfer of thermal energy end. For a visual explanation of these concepts, watch the animation "Temperature vs. Heat" at this URL: <http://www.sciencehelpdesk.com/unit/science2/3> .

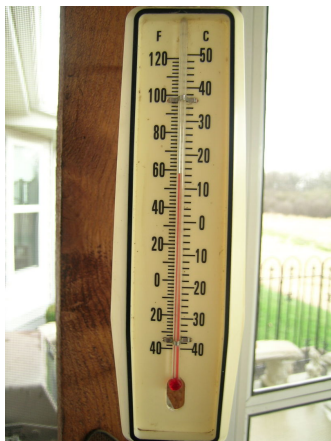
**FIGURE 18.2**

The red liquid in this thermometer is alcohol. Alcohol expands uniformly over a wide range of temperatures. This makes it ideal for use in thermometers.

Example of Thermal Energy Transfer

Figure 18.3 illustrates an example of thermal energy transfer. Before the spoon was put into the steaming hot coffee, it was cool to the touch. Once in the coffee, the spoon heated up quickly. The fast-moving particles of the coffee transferred some of their energy to the slower-moving particles of the spoon. The spoon particles started moving faster and became warmer, causing the temperature of the spoon to rise. Because the coffee particles lost some of their kinetic energy to the spoon particles, the coffee particles started to move more slowly. This caused the temperature of the coffee to fall. Before long, the coffee and spoon had the same temperature.

**FIGURE 18.3**

A cool spoon gets warmer when it is placed in a hot liquid. Can you explain why?

Specific Heat

The girls in **Figure 18.4** are having fun at the beach. It's a warm, sunny day, and the sand feels hot under their bare hands and feet. The water, in contrast, feels much cooler. Why does the sand get so hot while the water does not? The answer has to do with specific heat.

Specific heat is the amount of energy (in joules) needed to raise the temperature of 1 gram of a substance by 1°C. Specific heat is a property that is specific to a given type of matter. **Table 18.1** lists the specific heat of four

**FIGURE 18.4**

Sand on a beach heats up quickly in the sun because sand has a relatively low specific heat.

different substances. Metals such as iron have relatively low specific heat. It doesn't take much energy to raise their temperature. That's why a metal spoon heats up quickly when placed in hot coffee. Sand also has a relatively low specific heat, whereas water has a very high specific heat. It takes a lot more energy to increase the temperature of water than sand. This explains why the sand on a beach gets hot while the water stays cool. Differences in the specific heat of water and land also affect climate. To learn how, watch the video at this URL: <http://www.youtube.com/watch?v=dkBStF2Rnu4> (7:07).

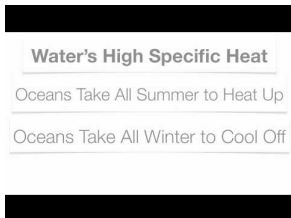
**MEDIA**

Click image to the left for more content.

In **Table 18.1**, how much greater is the specific heat of water than sand?

TABLE 18.1: Specific Heat of Some Common Substances

Substances	Specific Heat (joules)
iron	0.45
sand	0.67
wood	1.76
water	4.18

Lesson Summary

- Temperature is the average kinetic energy of particles of an object. Warmer objects have faster particles and higher temperatures. If two objects have the same mass, the object with the higher temperature has greater thermal energy. Temperature is measured with a thermometer.
- Heat is the transfer of thermal energy between objects that have different temperatures. Thermal energy always moves from an object with a higher temperature to an object with a lower temperature. Specific heat is the amount of energy (in joules) needed to raise the temperature of 1 gram of a substance by 1°C. Substances differ in their specific heat.

5. Glass has a specific heat of $0.84 \text{ J/g}\cdot^{\circ}\text{C}$. Copper has a specific heat of $0.39 \text{ J/kg}\cdot^{\circ}\text{C}$. Which material takes more energy to warm up?

Think Critically

6. Explain how a cooler object can have more thermal energy than a warmer object.
7. Relate heat to temperature.

Points to Consider

In this lesson, you read that heat is the transfer of thermal energy from one object to another.

- How do you think the transfer of thermal energy occurs? For example, how does thermal energy move from hot sand to bare feet when someone walks on a beach?
- Do you think there might be more than one way that thermal energy can be transferred? For example, how does thermal energy move from a bonfire to a nearby person who isn't touching the flames?

18.2 Transfer of Thermal Energy

Lesson Objectives

- Describe the conduction of thermal energy.
- Explain how convection transfers thermal energy.
- Give an example of the radiation of thermal energy.

Lesson Vocabulary

- conduction
- convection
- convection current
- thermal conductor
- thermal insulator

Introduction

Did you ever cook over a campfire? The man in the **Figure 18.5** is waiting for his lunch to finish cooking over the campfire. Thermal energy from the fire heats the water. Eventually, all the water in the pot will be boiling hot. The man also feels warm from the flames, even though he isn't touching them. Thermal energy is transferred from the fire in three ways: conduction, convection, and radiation. You'll read about each way in this lesson. For an animated preview of the three ways, go to this URL: <http://www.nd.edu/~ysun/Yang/PhysicsAnimation/collection/transportP.swf> .



FIGURE 18.5

Thermal energy from the fire is transferred to the pot and water and to the man sitting by the fire.

Conduction

Conduction is the transfer of thermal energy between particles of matter that are touching. When energetic particles collide with nearby particles, they transfer some of their thermal energy. From particle to particle, like dominoes

falling, thermal energy moves throughout a substance. In **Figure 18.5**, conduction occurs between particles of the metal in the pot and between particles of the pot and the water. **Figure 18.6** shows additional examples of conduction. For a deeper understanding of this method of heat transfer, watch the animation "Conduction" at this URL: <http://www.sciencehelpdesk.com/unit/science2/3> .



Hands feel cold when they're holding ice because they lose thermal energy to the ice.



Hair feels warm after a hot curling iron passes over it because it gains thermal energy from the curling iron.

FIGURE 18.6

How is thermal energy transferred in each of these examples?

Thermal Conductors

Conduction is usually faster in liquids and certain solids than in gases. Materials that are good conductors of thermal energy are called **thermal conductors**. Metals are excellent thermal conductors. They have freely moving electrons that can transfer energy quickly and easily. That's why the metal pot in **Figure 18.5** soon gets hot all over, even though it gains thermal energy from the fire only at the bottom of the pot. In **Figure 18.6**, the metal heating element of the curling iron heats up almost instantly and quickly transfers energy to the strands of hair that it touches.

Thermal Insulators

Particles of gases are farther apart and have fewer collisions, so they are not good at transferring thermal energy. Materials that are poor thermal conductors are called **thermal insulators**. **Figure 18.7** shows several examples. Fluffy yellow insulation inside the roof of a home is full of air. The air prevents the transfer of thermal energy into the house on hot days and out of the house on cold days. A puffy down jacket keeps you warm in the winter for the same reason. Its feather filling holds trapped air that prevents energy transfer from your warm body to the cold air outside. Solids like plastic and wood are also good thermal insulators. That's why pot handles and cooking utensils are often made of these materials.

Convection

Convection is the transfer of thermal energy by particles moving through a fluid. Particles transfer energy by moving from warmer to cooler areas. That's how energy is transferred in the soup in **Figure 18.7**. Particles of soup near the bottom of the pot get hot first. They have more energy so they spread out and become less dense. With lower density, these particles rise to the top of the pot (see **Figure 18.8**). By the time they reach the top of the pot they have cooled off. They have less energy to move apart, so they become denser. With greater density, the particles sink to the bottom of the pot, and the cycle repeats. This loop of moving particles is called a **convection current**.

Convection currents move thermal energy through many fluids, including molten rock inside Earth, water in the oceans, and air in the atmosphere. In the atmosphere, convection currents create wind. You can see one way this happens in **Figure 18.9**. Land heats up and cools off faster than water because it has lower specific heat. Therefore,

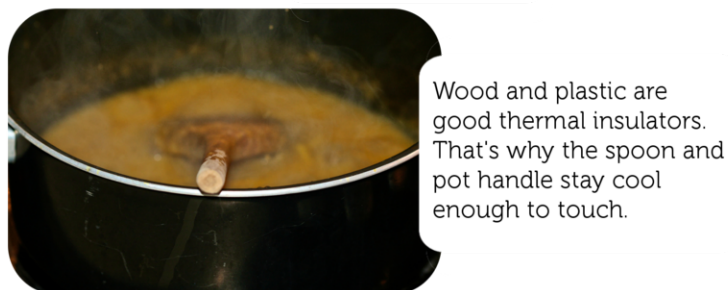
**FIGURE 18.7**

Thermal insulators have many practical uses. Can you think of others?

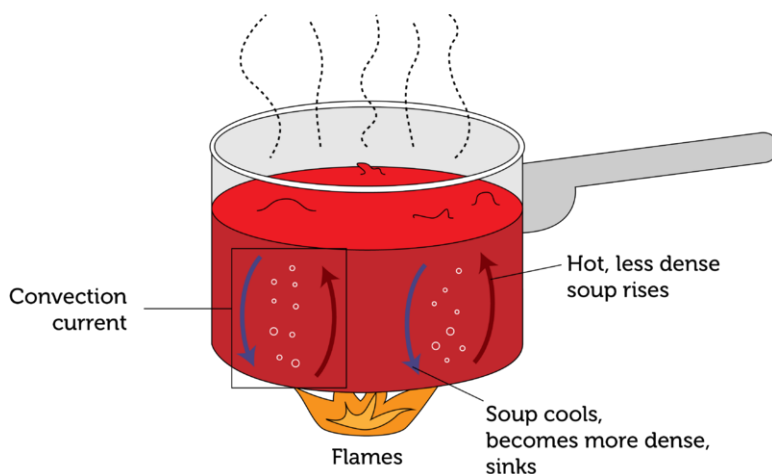
**FIGURE 18.8**

Convection currents carry thermal energy throughout the soup in the pot.

land is warmer during the day and cooler at night than water. Air close to the surface gains or loses heat as well. Warm air rises because it is less dense, and when it does, cool air moves in to take its place. This creates a convection current that carries air from the warmer to the cooler area. You can learn more about convection currents by watching "Convection" at this URL: <http://www.sciencehelpdesk.com/unit/science2/3> .

Radiation

Both conduction and convection transfer energy through matter. Radiation is the only way of transferring energy that doesn't require matter. Radiation is the transfer of energy by waves that can travel through empty space. When the waves reach objects, they transfer energy to the objects, causing them to warm up. This is how the sun's energy

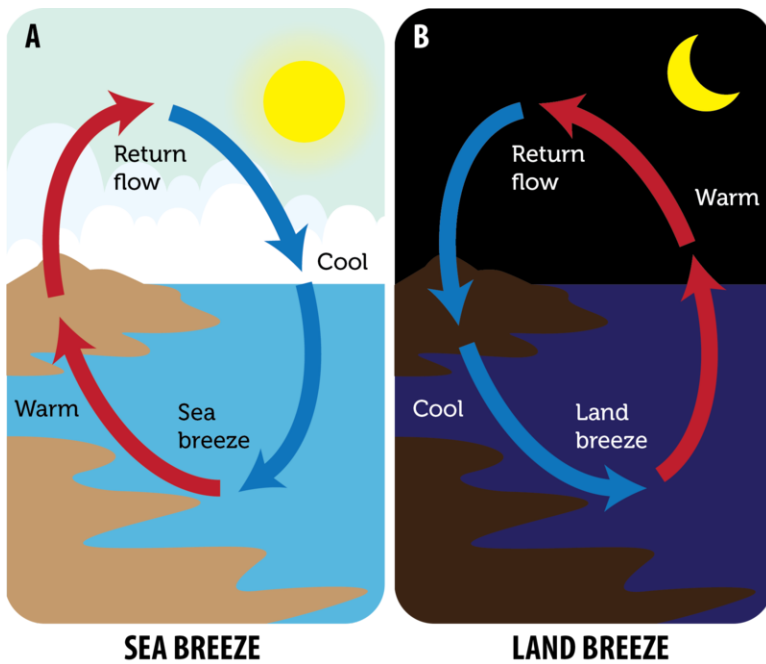

FIGURE 18.9

A sea breeze blows toward land during the day, and a land breeze blows toward water at night. Why does the wind change direction after the sun goes down?

reaches Earth and heats its surface (see **Figure 18.10**). Radiation is also how thermal energy from a campfire warms people nearby. You might be surprised to learn that all objects radiate thermal energy, including people. In fact, when a room is full of people, it may feel noticeably warmer because of all the thermal energy the people radiate! To learn more about thermal radiation, watch "Radiation" at the URL below.

<http://www.sciencehelpdesk.com/unit/science2/3>

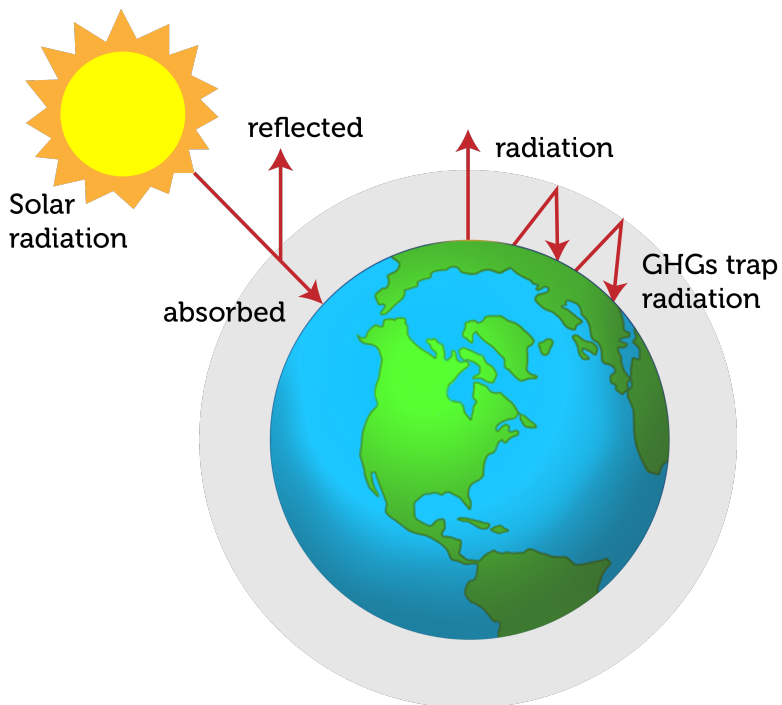

FIGURE 18.10

Earth is warmed by energy that radiates from the sun. Earth radiates some of the energy back into space. Greenhouse gases (GHGs) trap much of the re-radiated energy, causing an increase in the temperature of the atmosphere close to the surface.

Lesson Summary

- Conduction is the transfer of thermal energy between particles of matter that are touching. Thermal conductors are materials that are good conductors of thermal energy. Thermal insulators are materials that are poor conductors of thermal energy. Both conductors and insulators have important uses.
- Convection is the transfer of thermal energy by particles moving through a fluid. The particles transfer energy by moving from warmer to cooler areas. They move in loops called convection currents.
- Radiation is the transfer of thermal energy by waves that can travel through empty space. When the waves reach objects, they transfer thermal energy to the objects. This is how the sun's energy reaches and warms Earth.

Lesson Review Questions

Recall

1. Define conduction.
2. What is convection?
3. Define the radiation of thermal energy.

Apply Concepts

4. Fill in each blank in the diagram below with the correct method of heat transfer.

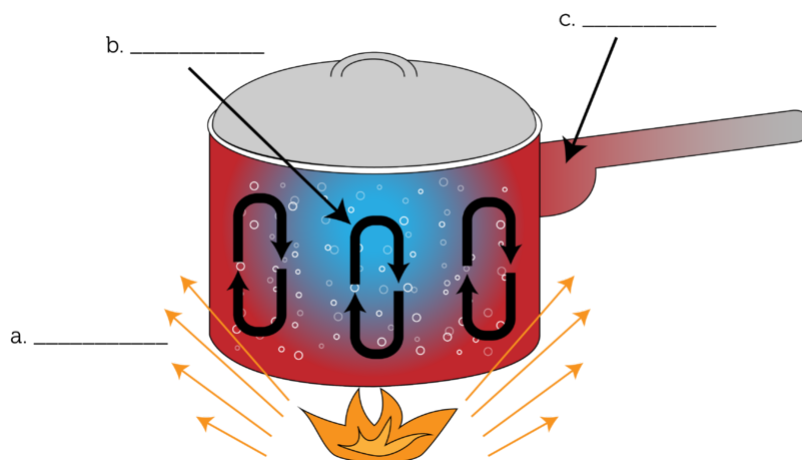

5. How could you insulate an ice cube to keep it from melting? What material(s) would you use?

Think Critically

6. Why does convection occur only in fluids?
7. George says that insulation keeps out the cold. Explain why this statement is incorrect. What should George have said?

Points to Consider

Thermal energy is very useful. For example, we use thermal energy to keep our homes warm and our motor vehicles moving.

- How does thermal energy heat a house? What devices and systems are involved?
- How does thermal energy run a car? How does burning gas in the engine cause the wheels to turn?

18.3 Using Thermal Energy

Lesson Objectives

- Identify common home heating systems.
- Explain how a cooling system transfers thermal energy.
- Outline how a combustion engine works.

Lesson Vocabulary

- combustion engine
- refrigerant

Introduction

Ashley feels chilly, so she turns up the thermostat (pictured in **Figure 18.11**). She hears the furnace switch on in the basement, and in just a few minutes, warm air is blowing out of vents in the floor. Before long, the whole house is much warmer. Modern home heating systems keep us comfortable in cold weather. We may even depend on them for our survival. But we often take them for granted. Do you know how a home heating system works? Do you know how it turns fuel to thermal energy or how it circulates thermal energy throughout the house? In this lesson, you'll find out.



FIGURE 18.11

The thermostat of a home heating system controls the furnace, which heats the house.

Heating Systems

Warming homes and other buildings is an obvious way that thermal energy can be used. Two common types of home heating systems are hot-water and warm-air heating systems. Both types are described below. You can watch an animation showing how a solar heating system works at this URL: http://www.montereyinstitute.org/courses/AP%20Environmental%20Science/course%20files/multimedia/lesson67/animations/4e_solar_heating_system.html .

Hot-Water Heating System

A hot-water heating system uses thermal energy to heat water and then pumps the hot water throughout the building in a system of pipes and radiators. You can see a diagram of this type of heating system in **Figure 18.12**. Typically, the water is heated in a boiler that burns natural gas or heating oil. There is usually a radiator in each room that gets warm when the hot water flows through it. The radiator transfers thermal energy to the air around it by conduction and radiation. The warm air then circulates throughout the room in convection currents. The hot water cools as it flows through the system and transfers its thermal energy. When it finally returns to the boiler, it is heated again and the cycle repeats.

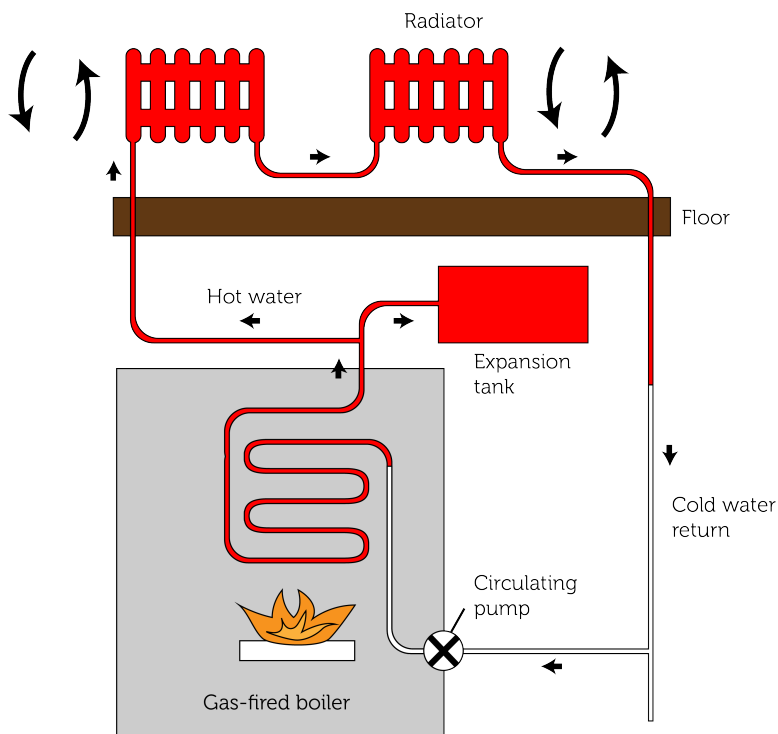

FIGURE 18.12

When water is heated in the boiler, it expands. It might burst the pipes of the system if it weren't for the expansion tank. This tank holds excess water after it expands.

Warm-Air Heating System

A warm-air heating system uses thermal energy to heat air. It then forces the warm air through a system of ducts. You can see a diagram of this type of heating system in **Figure 18.13**. Typically, the air is heated in a furnace that burns natural gas or heating oil. When the air is warm, a fan blows it through the ducts and out through vents that are located in each room. Warm air blowing out of a vent moves across the room, pushing cold air out of the way. The cold air enters an intake vent on the opposite side of the room and returns to the furnace with the help of another fan. In the furnace, the cold air is heated, and the cycle repeats.

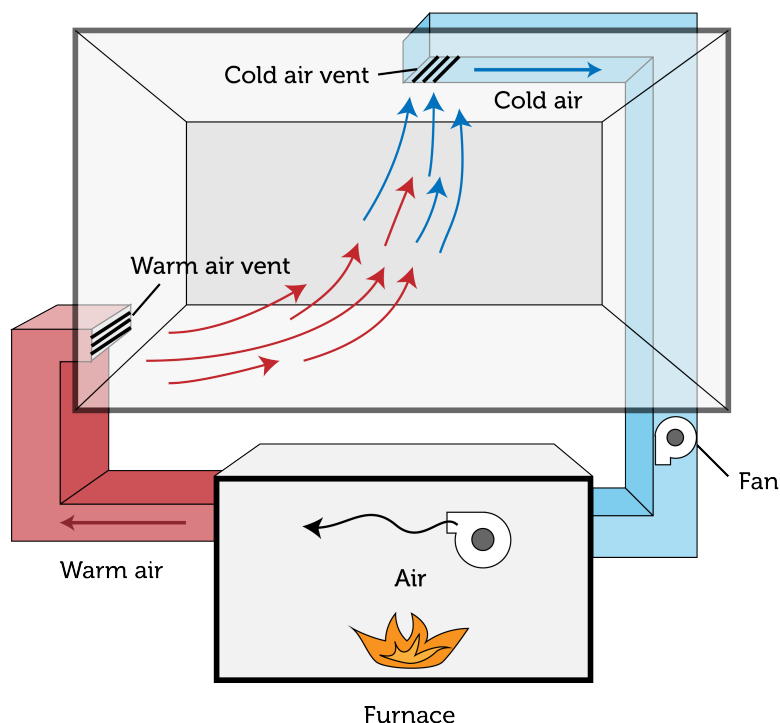

FIGURE 18.13

The warm-air vent is placed near the floor of the room. Warm air is less dense than cold air so it rises. If the warm-air vent were placed near the ceiling instead, how would this affect the transfer of thermal energy throughout the room?

Cooling Systems

It's easy to see how thermal energy can be used to keep things warm. But did you know that thermal energy can also be used to keep things cool? Cooling systems such as air conditioners and refrigerators transfer thermal energy in order to keep homes and cars cool or to keep food cold. In a refrigerator, for example, thermal energy is transferred from the cool air inside the refrigerator to the warmer air in the kitchen. You read in this chapter's "Transfer of Thermal Energy" lesson that thermal energy always moves from a warmer area to a cooler area, so how can it move from the cooler refrigerator to the warmer room? The answer is work. The refrigerator does work to transfer thermal energy in this way. Doing this work takes energy, which is usually provided by electricity. **Figure 18.14** explains how a refrigerator does its work.

For an animated demonstration of how a refrigerator works, go to this URL: http://www.chemistry.wustl.edu/~courses/genchem/LabTutorials/Thermochem/fridge_movie.html .

The key to how a refrigerator or other cooling system works is the refrigerant. A **refrigerant** is a substance, such as Freon™, that has a low boiling point and changes between liquid and gaseous states as it passes through the cooling system. As a liquid, the refrigerant absorbs thermal energy from the cool air inside the refrigerator and changes to a gas. As a gas, it releases thermal energy to the warm air outside the refrigerator and changes back to a liquid.

Combustion Engines

A **combustion engine** is a complex machine that burns fuel to produce thermal energy and then uses the energy to do work. Two basic types of combustion engines are external and internal combustion engines.

How a Refrigerator Works

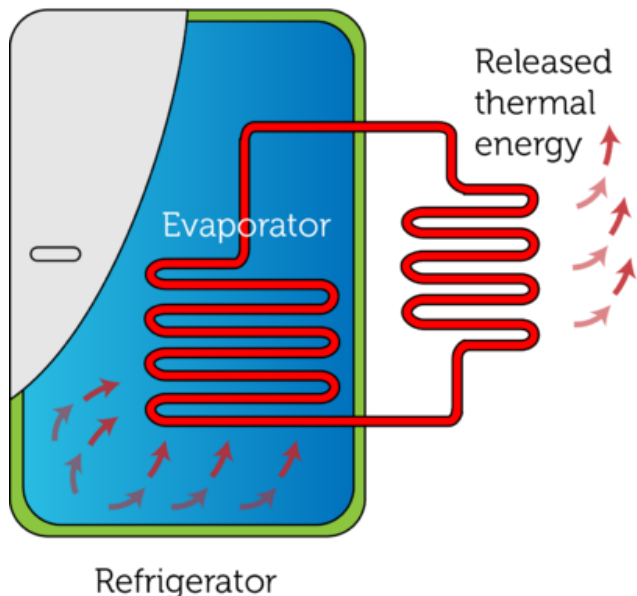

1. Thermal energy is transferred from the cool air inside the refrigerator to cold liquid refrigerant as it flows through the evaporator. When the refrigerant absorbs the thermal energy, it gets warmer and changes to a gas.
2. The gaseous refrigerant flows to the compressor, which compresses the refrigerant and raises its temperature even higher.
3. The hot refrigerant gas flows to the condenser, where it transfers its thermal energy to the cooler condenser coils. As the refrigerant loses thermal energy, it cools and condenses back to a liquid.
4. The liquid refrigerant flows to the expansion device, where it has room to spread out. This lowers its temperature even more.
5. The cold liquid refrigerant flows to the evaporator, and the cycle repeats.

FIGURE 18.14

A refrigerator must do work to reverse the normal direction of heat flow.

External Combustion Engine

An external combustion engine burns fuel externally, or outside the engine. The burning fuel releases thermal energy that is used to turn water to steam. The pressure of the steam is then used to move a piston back and forth in a cylinder. The kinetic energy of the moving piston can be used to turn a turbine or other device. **Figure 18.15** explains in greater detail how this type of engine works. You can see an animated version of an external combustion engine at this URL: <http://science.howstuffworks.com/transport/engines-equipment/steam1.htm> .

Internal Combustion Engine

An internal combustion engine (see **Figure 18.16**) burns fuel internally, or inside the engine. This type of engine is found in most cars and other motor vehicles. It works in these steps, which keep repeating:

1. A mixture of fuel and air is pulled into a cylinder through a valve, which then closes.
2. The piston is pushed upward, compressing the fuel-air mixture in the closed cylinder. The mixture is now under a lot of pressure and very warm.
3. A spark from a spark plug is used to ignite the fuel-air mixture, causing it to burn explosively within the confined space of the closed cylinder.
4. The pressure of the hot gases from combustion forces the piston downward.
5. When the piston moves up again, it forces the exhaust gases of combustion out of the cylinder through another valve. Then the process repeats.

External Combustion Engine

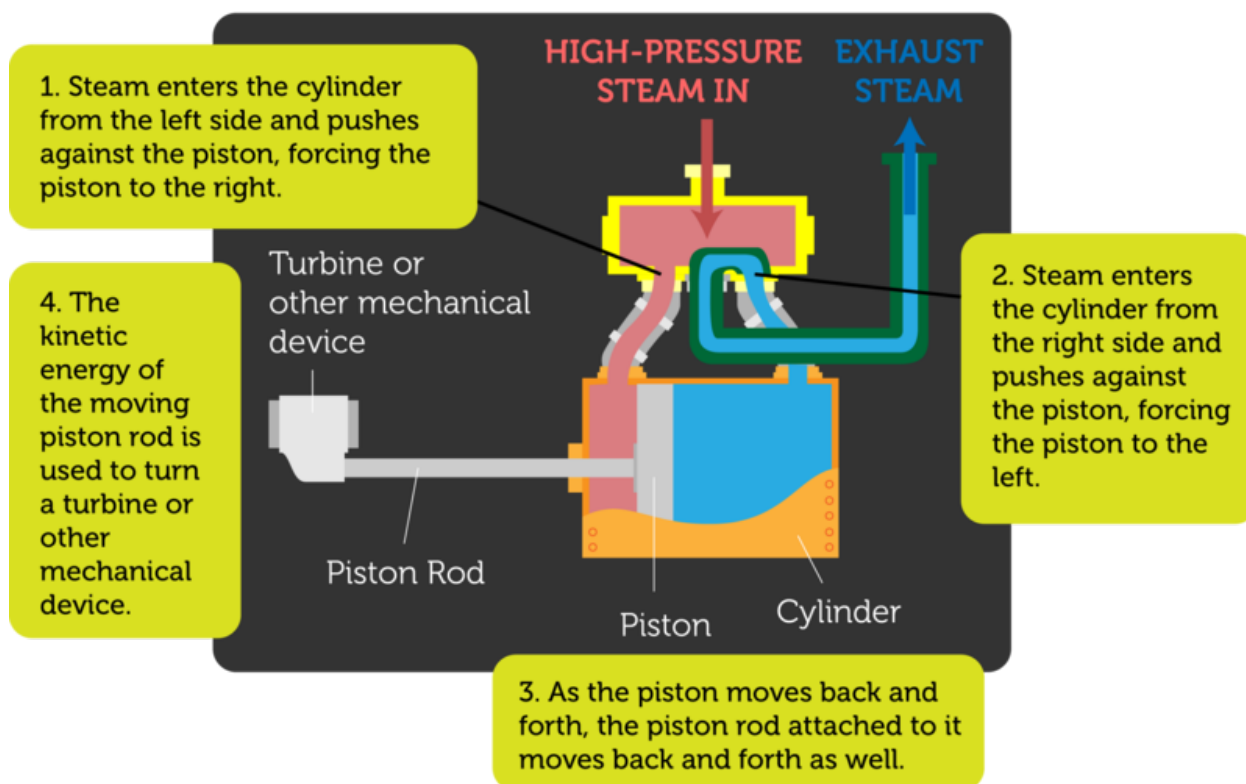

FIGURE 18.15

Thermal energy is converted to the kinetic energy of the moving piston inside the cylinder. The moving piston, in turn, can be used to turn a turbine or do other useful work.

In a car, the piston is connected by the piston rod to the crankshaft. The crankshaft rotates when the piston moves up and down. The kinetic energy of the moving crankshaft is used to turn the driveshaft, which causes the wheels of the car to turn. Most cars have at least four cylinders connected to the crankshaft. Their pistons move up and down in sequence, one after the other. You can watch animations of internal combustion engines in action at these URLs:

- <http://auto.howstuffworks.com/engine1.htm>
- <http://www.familycar.com/Engine.htm>

Lesson Summary

- Two common home heating systems are hot-water and warm-air heating systems. They burn fuel for thermal energy and transfer the energy to water or air. The heated water or air circulates throughout the house, transferring thermal energy to the air in each room.
- Cooling systems such as air conditioners and refrigerators reverse the normal direction of heat flow by doing work. For example, a refrigerator uses a refrigerant to transfer thermal energy from a cool refrigerator to a

Internal Combustion Engine

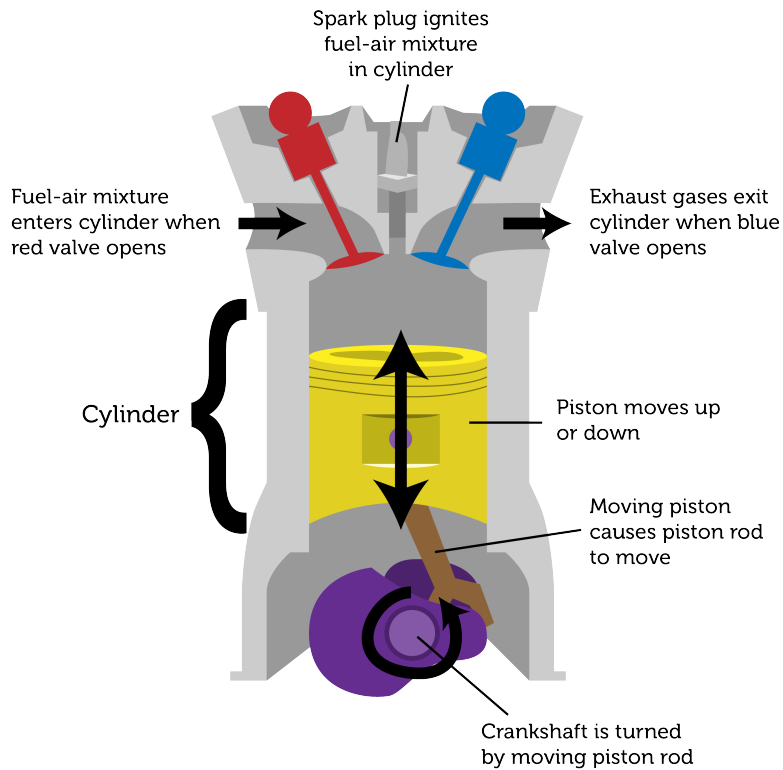

FIGURE 18.16

Combustion within the closed cylinder pushes the piston downward. The moving piston turns the crankshaft.

warm room.

- A combustion engine is a complex machine that burns fuel to produce thermal energy and then uses the thermal energy to do work. Combustion engines may be external or internal combustion engines, depending on where the fuel is burned.

Lesson Review Questions

Recall

1. How does a hot-water radiator transfer thermal energy to the nearby air?
2. What is a refrigerant?
3. What is the direction of thermal energy flow in a refrigerator?
4. How does a combustion engine use thermal energy?

Apply Concepts

5. Create a sketch to model a home heating system. You may model either a hot-water system or a warm-air system.

Think Critically

6. Compare and contrast external and internal combustion engines.

Points to Consider

In this chapter, you read that thermal energy can travel in waves by radiation. You can learn more about waves in the next chapter.

- What other forms of energy travel in waves? (*Hint*: How does sound energy travel?)
- Think about waves in the ocean. How do the waves move? How do you think they carry energy?

18.4 References

1. Cocoa: F_A (Flickr:seelensturm); Boy in bath: Brandon Doan (Flickr:bdoggut34). Cocoa: <http://www.flickr.com/photos/seelensturm/8401926552/>; Boy in bath: <http://www.flickr.com/photos/bdoggut34/3749195206/> . CC BY 2.0
2. Jessica Mullen. <http://www.flickr.com/photos/jessicamullen/130940810/> . CC BY 2.0
3. Basheer Tome. <http://www.flickr.com/photos/basheertome/6971028847/> . CC BY 2.0
4. Mike Baird. <http://www.flickr.com/photos/mikebaird/7476468820/> . CC BY 2.0
5. Erik Halfacre. <http://www.flickr.com/photos/erikhalfacre/8730126558/> . CC BY 2.0
6. Ice in hands: Visit Greenland (Flickr:greenland_com); Woman with iron: Maegan Tintari. Ice in hands: <http://www.flickr.com/photos/ilovegreenland/6099497074/>; Woman with iron: <http://www.flickr.com/photos/lovemaegan/6324422379/> . CC BY 2.0
7. Insulation: Flickr:Epic Fireworks; Child in jacket: Mark Baylor; Soup: Simon Doggett. Insulation: <http://www.flickr.com/photos/epicfireworks/4603519682/>; Child in jacket: <http://www.flickr.com/photos/baylors/5283466866/>; Soup: www.flickr.com/photos/90037546@N00/3156066767/ . CC BY 2.0
8. Christopher Auyeung. [CK-12 Foundation](#) . CC BY-NC 3.0
9. Christopher Auyeung. [CK-12 Foundation](#) . CC BY-NC 3.0
10. Christopher Auyeung and Laura Guerin. [CK-12 Foundation](#) . CC BY-NC 3.0
11. Joy Sheng. [CK-12 Foundation](#) . CC BY-NC 3.0
12. Christopher Auyeung. [CK-12 Foundation](#) . CC BY-NC 3.0
13. Christopher Auyeung. [CK-12 Foundation](#) . CC BY-NC 3.0
14. Christopher Auyeung. [CK-12 Foundation](#) . CC BY-NC 3.0
15. Christopher Auyeung. [CK-12 Foundation](#) . CC BY-NC 3.0
16. Christopher Auyeung. [CK-12 Foundation](#) . CC BY-NC 3.0

CHAPTER 19**Waves****Chapter Outline**

- 19.1 CHARACTERISTICS OF WAVES**
 - 19.2 MEASURING WAVES**
 - 19.3 WAVE INTERACTIONS AND INTERFERENCE**
 - 19.4 REFERENCES**
-



This immense wall of moving water gives the surfer an amazing ride. The swelling surf will raise him up and push him forward as though he's as light as a feather. All he needs to do is keep his balance on the surfboard. The incredible power of the wave will do the rest. When you think of waves, ocean waves like this one probably come to mind. But there are many other examples of waves, some that affect all of us in our daily lives. What are waves, and what causes them? What are some other examples of waves? Read on to find out.

Image copyright EpicStockMedia, 2013. www.shutterstock.com. Used under license from Shutterstock.com.

19.1 Characteristics of Waves

Lesson Objectives

- Define mechanical wave.
- Describe transverse waves.
- Identify longitudinal waves.
- Describe surface waves.

Lesson Vocabulary

- longitudinal wave
- mechanical wave
- surface wave
- transverse wave

Introduction

Ocean waves are among the most impressive waves in the world. They clearly show that waves transfer energy. In the case of ocean waves, energy is transferred through matter. But some waves, called electromagnetic waves, can transfer energy without traveling through matter. These waves can travel through space. You can read more about electromagnetic waves in the chapter "Electromagnetic Radiation." Waves that transfer energy through matter are the focus of the present chapter. These waves are called mechanical waves.

Mechanical Waves

A **mechanical wave** is a disturbance in matter that transfers energy from place to place. A mechanical wave starts when matter is disturbed. An example of a mechanical wave is pictured in **Figure 19.1**. A drop of water falls into a pond. This disturbs the water in the pond. What happens next? The disturbance travels outward from the drop in all directions. This is the wave. A source of energy is needed to start a mechanical wave. In this case, the energy comes from the falling drop of water.

The Medium

The energy of a mechanical wave can travel only through matter. This matter is called the medium (*plural, media*). The medium in **Figure 19.1** is a liquid—the water in the pond. But the medium of a mechanical wave can be any state of matter, including a solid or a gas. It's important to note that particles of matter in the medium don't actually

**FIGURE 19.1**

A drop of water causes a disturbance that travels through the pond as a wave.

travel along with the wave. Only the energy travels. The particles of the medium just vibrate, or move back-and-forth or up-and-down in one spot, always returning to their original positions. As the particles vibrate, they pass the energy of the disturbance to the particles next to them, which pass the energy to the particles next to them, and so on.

Types of Mechanical Waves

There are three types of mechanical waves. They differ in how they travel through a medium. The three types are transverse, longitudinal, and surface waves. All three types are described in detail below.

Transverse Waves

A **transverse wave** is a wave in which the medium vibrates at right angles to the direction that the wave travels. An example of a transverse wave is a wave in a rope, like the one pictured in **Figure 19.2**. In this wave, energy is provided by a person's hand moving one end of the rope up and down. The direction of the wave is down the length of the rope away from the person's hand. The rope itself moves up and down as the wave passes through it. You can see a brief video of a transverse wave in a rope at this URL: <http://www.youtube.com/watch?v=TZIr9mpERbU> .

To see a transverse wave in slow motion, go to this URL: <http://www.youtube.com/watch?v=g49mahYeNgc> (0:22).



MEDIA

Click image to the left for more content.

Crests and Troughs

A transverse wave can be characterized by the high and low points reached by particles of the medium as the wave passes through. This is illustrated in **Figure 19.3**. The high points are called crests, and the low points are called troughs.

S Waves

Another example of transverse waves occurs with earthquakes. The disturbance that causes an earthquake sends transverse waves through underground rocks in all directions from the disturbance. Earthquake waves that travel this

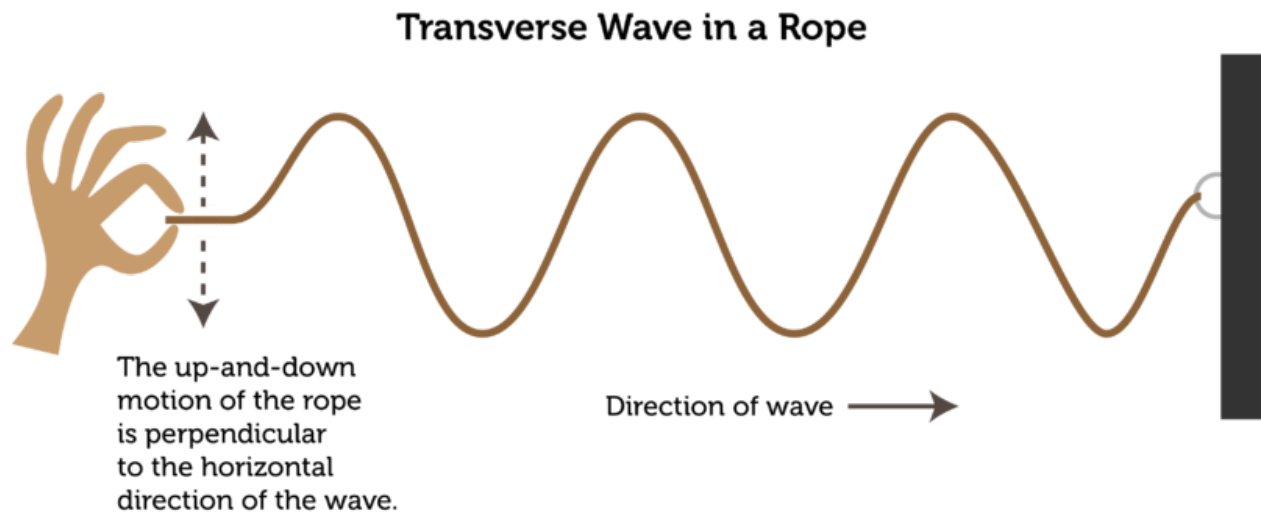
**FIGURE 19.2**

In a transverse wave, the medium moves at right angles to the direction of the wave.

Parts of a Transverse Wave

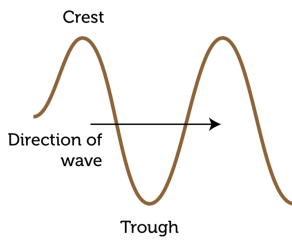
**FIGURE 19.3**

Crests and troughs are the high and low points of a transverse wave.

way are called secondary, or S, waves. An S wave is illustrated in **Figure 19.4**.

Motion of rock

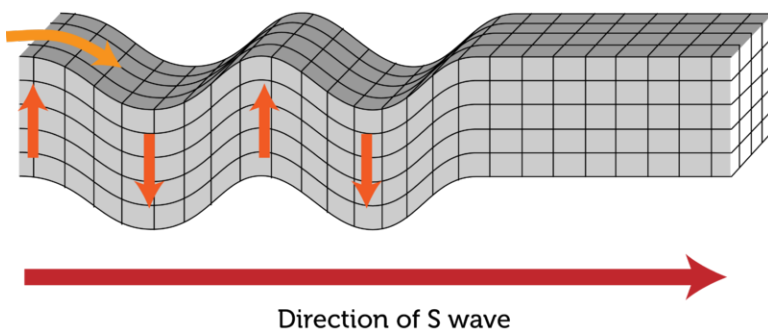
**FIGURE 19.4**

An S wave is a transverse wave that travels through rocks under Earth's surface.

Longitudinal Waves

A **longitudinal wave** is a wave in which the medium vibrates in the same direction that the wave travels. An example of a longitudinal wave is a wave in a spring, like the one in **Figure 19.5**. In this wave, the energy is provided by a person's hand pushing and pulling the spring. The coils of the spring first crowd closer together and then spread farther apart as the disturbance passes through them. The direction of the wave is down the length of the spring, or the same direction in which the coils move. You can see a video of a longitudinal wave in a spring at this URL: <http://www.youtube.com/watch?v=ubRlaCCQfDk> .

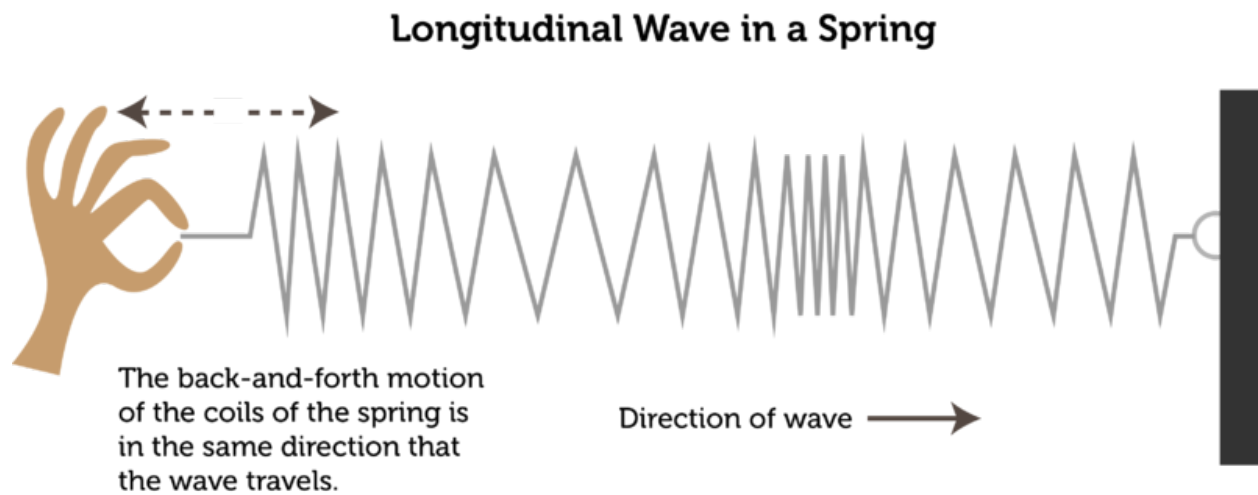

FIGURE 19.5

In a longitudinal wave, the medium moves back and forth in the same direction as the wave.

Compressions and Rarefactions

A longitudinal wave can be characterized by the compressions and rarefactions of the medium. This is illustrated in **Figure 19.6**. Compressions are the places where the coils are crowded together, and rarefactions are the places where the coils are spread apart.

P Waves

Earthquakes cause longitudinal waves as well as transverse waves. The disturbance that causes an earthquake sends longitudinal waves through underground rocks in all directions from the disturbance. Earthquake waves that travel this way are called primary, or P, waves. They are illustrated in **Figure 19.7**.

Parts of a Longitudinal Wave

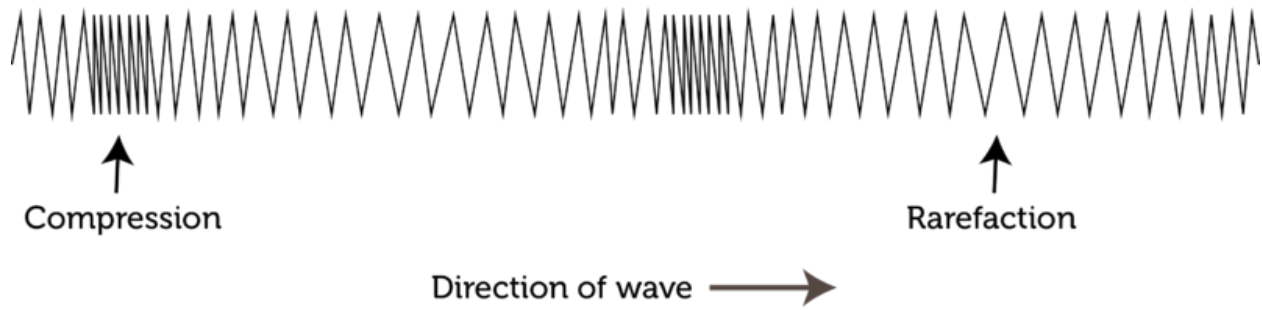

FIGURE 19.6

The compressions and rarefactions of a longitudinal wave are like the crests and troughs of a transverse wave.

P Waves

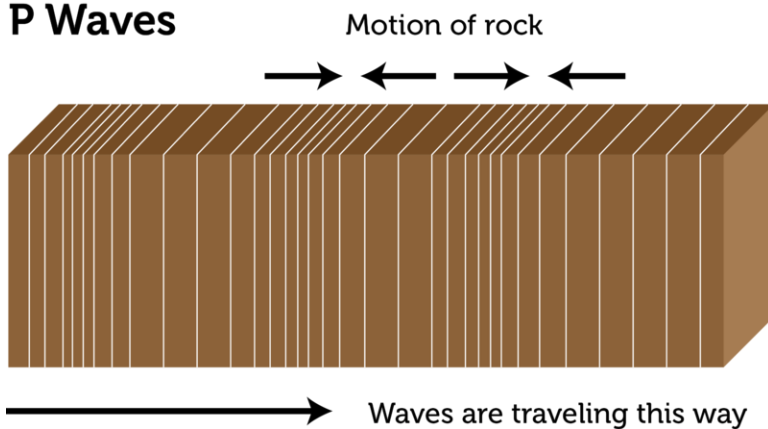

FIGURE 19.7

P waves are longitudinal waves that travel through rocks under Earth's surface.

Surface Waves

A **surface wave** is a wave that travels along the surface of a medium. It combines a transverse wave and a longitudinal wave. Ocean waves are surface waves. They travel on the surface of the water between the ocean and the air. In a surface wave, particles of the medium move up and down as well as back and forth. This gives them an overall circular motion. This is illustrated in **Figure 19.8** and at the URL below.

<http://www.youtube.com/watch?v=7yPTa8qi5X8> (0:57)

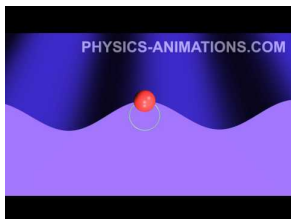

MEDIA

Click image to the left for more content.

How Particles Move in a Surface Wave

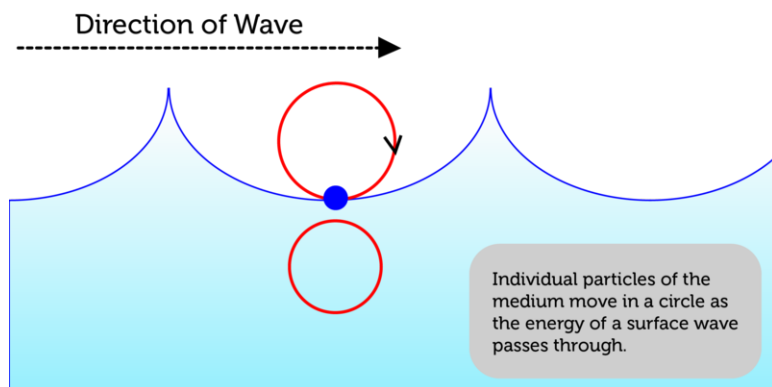

FIGURE 19.8

Surface waves are both transverse and longitudinal waves.

In deep water, particles of water just move in circles. They don't actually move closer to shore with the energy of the waves. However, near the shore where the water is shallow, the waves behave differently. They start to drag on the bottom, creating friction (see **Figure 19.9**). The friction slows down the bottoms of the waves, while the tops of the waves keep moving at the same speed. This causes the waves to get steeper until they topple over and crash on the shore. The crashing waves carry water onto the shore as surf.

Lesson Summary

- Mechanical waves are waves that transfer energy through matter, called the medium. Mechanical waves start when a source of energy causes a disturbance in the medium. Types of mechanical waves include transverse, longitudinal, and surface waves.
- In a transverse wave, such as a wave in a rope, the medium vibrates at right angles to the direction that the wave travels. The high points of transverse waves are called crests, and the low points are called troughs.
- In a longitudinal wave, such as a wave in a spring, the medium vibrates in the same direction that the wave travels. Places where the particles of the medium are closer together are called compressions, and places where they are farther apart are called rarefactions.
- A surface wave, such as an ocean wave, travels along the surface of a medium and combines a transverse wave and a longitudinal wave. Particles of the medium move in a circle as the surface wave passes through them.

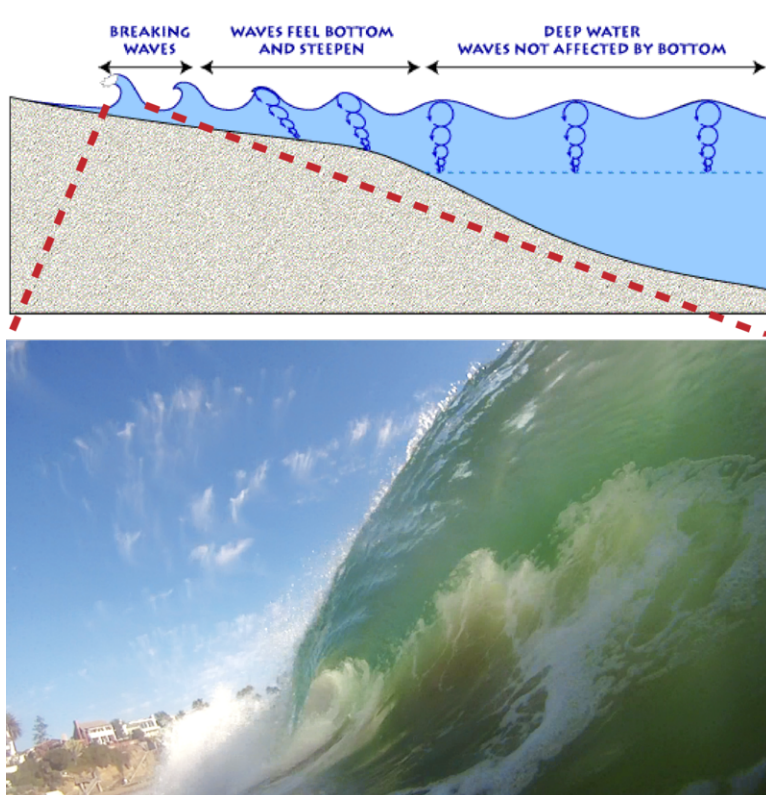

FIGURE 19.9

Waves topple over and break on the shore because of friction with the bottom in shallow water.

Lesson Review Questions

Recall

1. What is a mechanical wave?
2. Identify the medium of the wave in **Figure 19.1**.
3. Describe the compressions and rarefactions of a longitudinal wave.
4. What are surface waves? Give an example.
5. State how a particle of the medium moves when a surface wave passes through it.

Apply Concepts

6. Draw a sketch of a transverse wave. Label the crests and troughs, and add an arrow to show the direction the wave is traveling.

Think Critically

7. Compare and contrast P waves and S waves of earthquakes.

Points to Consider

When an earthquake occurs under the ocean, it sends waves through the water as well as the ground. When the energy of the earthquake reaches shore, it forms a huge wave called a tsunami.

- Do you know how large tsunamis are? How might the size of these and other waves be measured?
- What causes some waves to be bigger than others?

19.2 Measuring Waves

Lesson Objectives

- Define wave amplitude and wavelength.
- Relate wave speed to wave frequency and wavelength.

Lesson Vocabulary

- hertz (Hz)
- wave amplitude
- wave frequency
- wavelength
- wave speed

Introduction

Tsunamis, or the waves caused by earthquakes, are unusually large ocean waves. You can see an example of a tsunami in **Figure 19.10**. Because tsunamis are so big, they can cause incredible destruction and loss of life. The tsunami in the figure crashed into Thailand, sending people close to shore running for their lives. The height of a tsunami or other wave is just one way of measuring its size. You'll learn about this and other ways of measuring waves in this lesson.



FIGURE 19.10

This tsunami occurred in Thailand on December 26, 2004.

Wave Amplitude and Wavelength

The height of a wave is its amplitude. Another measure of wave size is wavelength. Both wave amplitude and wavelength are described in detail below. **Figure 19.11** shows these wave measures for both transverse and longitudinal waves. You can also simulate waves with different amplitudes and wavelengths by doing the interactive animation at this URL: <http://sci-culture.com/advancedpoll/GCSE/sine%20wave%20simulator.html> .

Transverse Wave

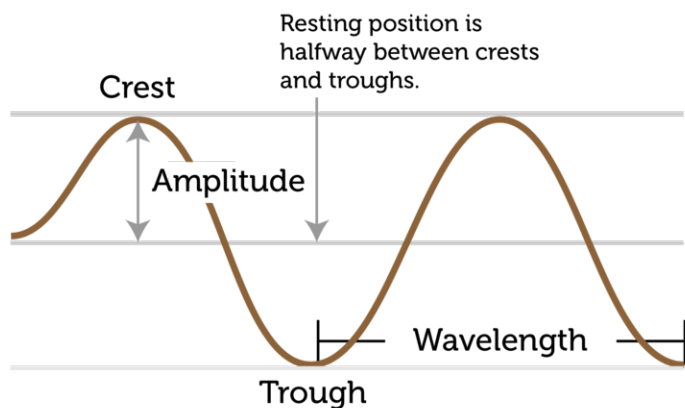
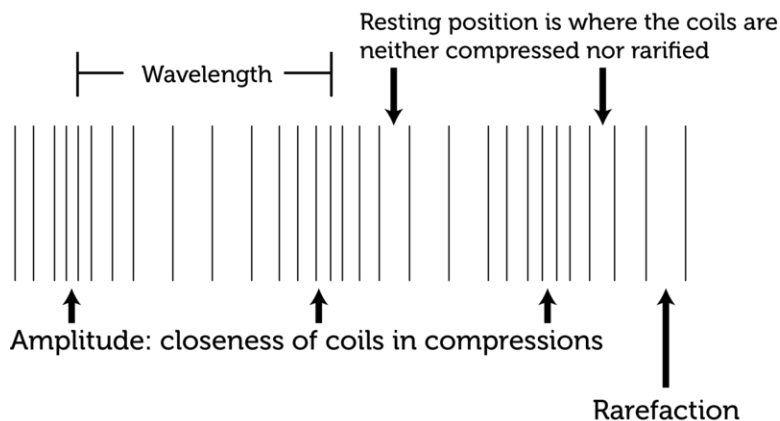

FIGURE 19.11

Wave amplitude and wavelength are two important measures of wave size.

Longitudinal Wave



Wave Amplitude

Wave amplitude is the maximum distance the particles of a medium move from their resting position when a wave passes through. The resting position is where the particles would be in the absence of a wave.

- In a transverse wave, wave amplitude is the height of each crest above the resting position. The higher the crests are, the greater the amplitude.
- In a longitudinal wave, amplitude is a measure of how compressed particles of the medium become when the wave passes through. The closer together the particles are, the greater the amplitude.

What determines a wave's amplitude? It depends on the energy of the disturbance that causes the wave. A wave caused by a disturbance with more energy has greater amplitude. Imagine dropping a small pebble into a pond of still water. Tiny ripples will move out from the disturbance in concentric circles, like those in **Figure 19.1**. The ripples are low-amplitude waves. Now imagine throwing a big boulder into the pond. Very large waves will be generated by the disturbance. These waves are high-amplitude waves.

Wavelength

Another important measure of wave size is wavelength. **Wavelength** is the distance between two corresponding points on adjacent waves (see **Figure 19.11**). Wavelength can be measured as the distance between two adjacent crests of a transverse wave or two adjacent compressions of a longitudinal wave. It is usually measured in meters. Wavelength is related to the energy of a wave. Short-wavelength waves have more energy than long-wavelength waves of the same amplitude. You can see examples of waves with shorter and longer wavelengths in **Figure 19.12**.

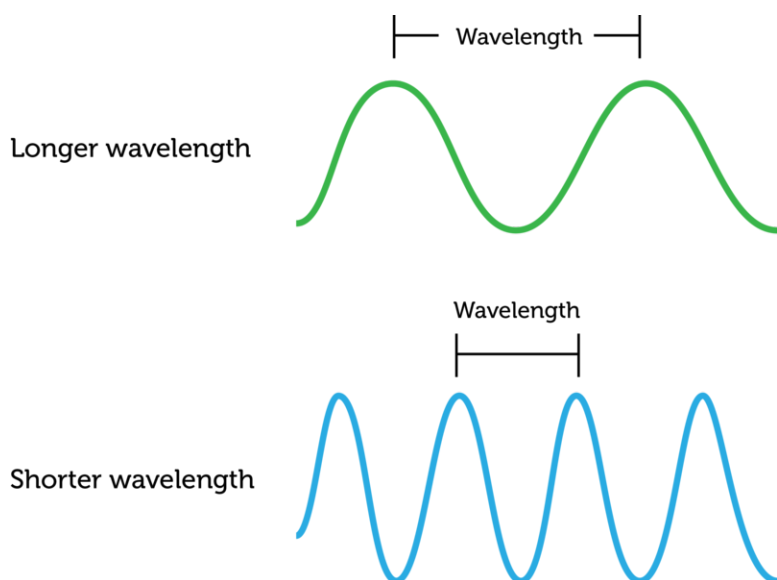

FIGURE 19.12

Both of these waves have the same amplitude, but they differ in wavelength. Which wave has more energy?

Wave Frequency and Speed

Imagine making transverse waves in a rope, like the waves in **Figure 19.2**. You tie one end of the rope to a doorknob or other fixed point and move the other end up and down with your hand. You can move the rope up and down slowly or quickly. How quickly you move the rope determines the frequency of the waves.

Wave Frequency

The number of waves that pass a fixed point in a given amount of time is **wave frequency**. Wave frequency can be measured by counting the number of crests or compressions that pass the point in 1 second or other time period. The higher the number is, the greater is the frequency of the wave. The SI unit for wave frequency is the **hertz (Hz)**, where 1 hertz equals 1 wave passing a fixed point in 1 second. **Figure 19.13** shows high-frequency and low-frequency transverse waves. You can simulate transverse waves with different frequencies at this URL: <http://zonal>

andeducation.com/mstm/physics/waves/partsOfAWave/waveParts.htm .

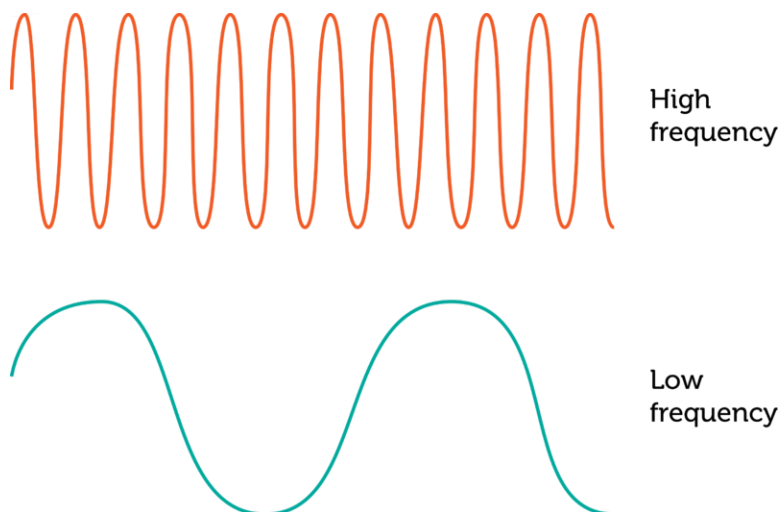

FIGURE 19.13

A transverse wave with a higher frequency has crests that are closer together.

The frequency of a wave is the same as the frequency of the vibrations that caused the wave. For example, to generate a higher-frequency wave in a rope, you must move the rope up and down more quickly. This takes more energy, so a higher-frequency wave has more energy than a lower-frequency wave with the same amplitude.

Wave Speed

Assume that you move one end of a rope up and down just once. How long will take the wave to travel down the rope to the other end? This depends on the speed of the wave. **Wave speed** is how far the wave travels in a given amount of time, such as how many meters it travels per second. Wave speed is not the same thing as wave frequency, but it is related to frequency and also to wavelength. This equation shows how the three factors are related:

$$\text{Speed} = \text{Wavelength} \times \text{Frequency}$$

In this equation, wavelength is measured in meters and frequency is measured in hertz, or number of waves per second. Therefore, wave speed is given in meters per second.

The equation for wave speed can be used to calculate the speed of a wave when both wavelength and wave frequency are known. Consider an ocean wave with a wavelength of 3 meters and a frequency of 1 hertz. The speed of the wave is:

$$\text{Speed} = 3 \text{ m} \times 1 \text{ wave/s} = 3 \text{ m/s}$$

You Try It!

Problem: Jera made a wave in a spring by pushing and pulling on one end. The wavelength is 0.1 m, and the wave frequency is 0.2 m/s. What is the speed of the wave?

If you want more practice calculating wave speed from wavelength and frequency, try the problems at this URL: <http://www.physicsclassroom.com/class/waves/u10l2e.cfm> .

The equation for wave speed (above) can be rewritten as:

$$\text{Frequency} = \frac{\text{Speed}}{\text{Wavelength}} \text{ or } \text{Wavelength} = \frac{\text{Speed}}{\text{Frequency}}$$

Therefore, if you know the speed of a wave and either the wavelength or wave frequency, you can calculate the missing value. For example, suppose that a wave is traveling at a speed of 2 meters per second and has a wavelength of 1 meter. Then the frequency of the wave is:

$$\text{Frequency} = \frac{2 \text{ m/s}}{1 \text{ m}} = 2 \text{ waves/s, or } 2 \text{ Hz}$$

You Try It!

Problem: A wave is traveling at a speed of 2 m/s and has a frequency of 2 Hz. What is its wavelength?

The Medium Matters

The speed of most waves depends on the medium through which they are traveling. Generally, waves travel fastest through solids and slowest through gases. That's because particles are closest together in solids and farthest apart in gases. When particles are farther apart, it takes longer for the energy of the disturbance to pass from particle to particle.

Lesson Summary

- Wave amplitude is the maximum distance the particles of a medium move from their resting positions as a wave passes through. Wavelength is the distance between two corresponding points of adjacent waves. Waves with greater amplitudes or shorter wavelengths have more energy.
- Wave frequency is the number of waves that pass a fixed point in a given amount of time. Higher frequency waves have more energy. Wave speed is calculated as wavelength multiplied by wave frequency. Wave speed is affected by the medium through which a wave travels.

Lesson Review Questions

Recall

1. How is wave amplitude measured in a transverse wave?
2. Describe the wavelength of a longitudinal wave.
3. Define wave frequency.

Apply Concepts

4. All of the waves in the sketch below have the same amplitude and speed. Which wave has the longest wavelength? Which has the highest frequency? Which has the greatest energy?

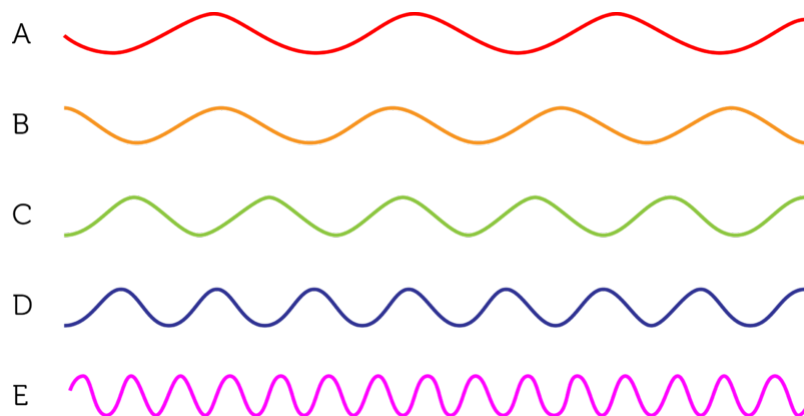

5. A wave has a wavelength of 0.5 m/s and a frequency of 2 Hz. What is its speed?

Think Critically

6. Relate wave amplitude, wavelength, and wave frequency to wave energy.
7. Waves A and B have the same speed, but wave A has a shorter wavelength. Which wave has the higher frequency? Explain how you know.

Points to Consider

You read in this lesson that waves travel at different speeds in different media.

- When a wave enters a new medium, it may speed up or slow down. What other properties of the wave do you think might change when it enters a new medium?
- What if a wave reaches a type of matter it cannot pass through? Does it just stop moving? If not, where does it go?

19.3 Wave Interactions and Interference

Lesson Objectives

- Describe wave reflection, refraction, and diffraction.
- Explain how wave interference affects the amplitude of waves.

Lesson Vocabulary

- diffraction
- reflection
- refraction
- standing wave
- wave interference

Introduction

Did you ever hear an echo of your own voice? An echo occurs when sound waves bounce back from a hard object. The man in **Figure 19.14** is trying to create an echo by shouting toward a rock wall. When the sound waves strike the rock wall, they can't pass through. Instead, they bounce back toward the man, and he hears an echo of his voice. An echo is just one example of how waves interact with matter.

Wave Interactions

Waves interact with matter in several ways. The interactions occur when waves pass from one medium to another. Besides bouncing back like an echo, waves may bend or spread out when they strike a new medium. These three ways that waves may interact with matter are called reflection, refraction, and diffraction. Each type of interaction is described in detail below. For animations of the three types of wave interactions, go to this URL: <http://www.acoustics.salford.ac.uk/schools/teacher/lesson3/flash/whiteboardcomplete.swf> .

Reflection

An echo is an example of wave reflection. Reflection occurs when waves bounce back from a barrier they cannot pass through. **Reflection** can happen with any type of waves, not just sound waves. For example, **Figure 19.15** shows the reflection of ocean waves off a rocky coast. Light waves can also be reflected. In fact, that's how we see most objects. Light from a light source, such as the sun or a light bulb, shines on the object and some of the light is reflected. When the reflected light enters our eyes, we can see the object.

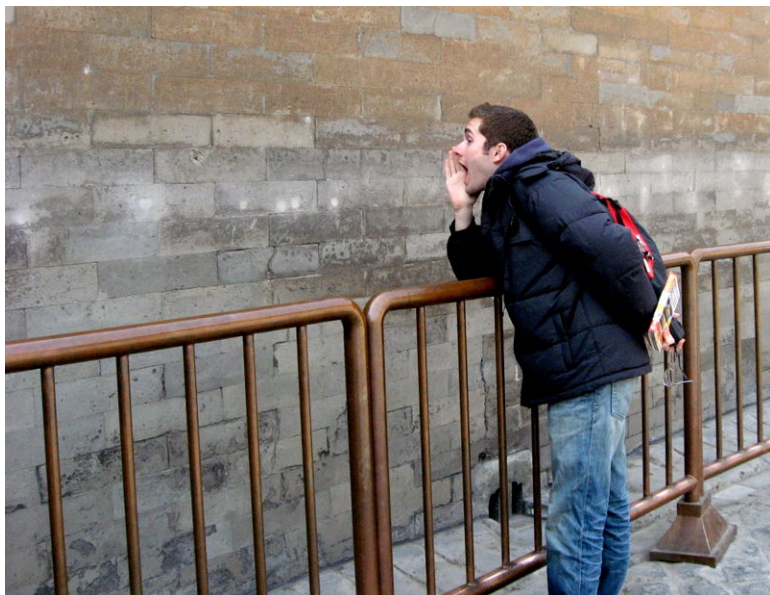
**FIGURE 19.14**

This man is sending sound waves toward a rock wall so he can hear an echo.

**FIGURE 19.15**

Ocean waves are reflected by rocks on shore.

Reflected waves have the same speed and frequency as the original waves before they were reflected. However, the direction of the reflected waves is different. When waves strike an obstacle head on, the reflected waves bounce straight back in the direction they came from. When waves strike an obstacle at any other angle, they bounce back at the same angle but in a different direction. This is illustrated in **Figure 19.16**.

Refraction

Refraction is another way that waves interact with matter. **Refraction** occurs when waves bend as they enter a new medium at an angle. You can see an example of refraction in **Figure 19.17**. Light bends when it passes from air to water. The bending of the light causes the pencil to appear broken.

Why do waves bend as they enter a new medium? Waves usually travel at different speeds in different media. For example, light travels more slowly in water than air. This causes it to refract when it passes from air to water.

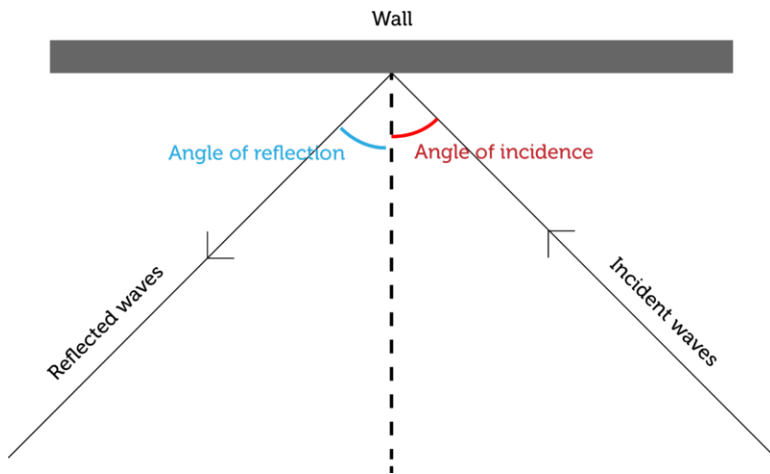
**FIGURE 19.16**

Waves strike a wall at an angle, called the angle of incidence. The waves are reflected at the same angle, called the angle of reflection, but in a different direction. Both angles are measured relative to a line that is perpendicular to the wall.

**FIGURE 19.17**

This pencil looks broken where it enters the water because of refraction of light waves.

Diffraction

Did you ever notice that when you're walking down a street, you can hear sounds around the corners of buildings? **Figure 19.18** shows why this happens. As you can see from the figure, sound waves spread out and travel around obstacles. This is called **diffraction**. It also occurs when waves pass through an opening in an obstacle. All waves may be diffracted, but it is more pronounced in some types of waves than others. For example, sound waves bend around corners much more than light does. That's why you can hear but not see around corners.

For a given type of waves, such as sound waves, how much the waves diffract depends on two factors: the size of the obstacle or opening in the obstacle and the wavelength. This is illustrated in **Figure 19.19**.

- Diffraction is minor if the length of the obstacle or opening is greater than the wavelength.
- Diffraction is major if the length of the obstacle or opening is less than the wavelength.

Diffraction of Sound Waves

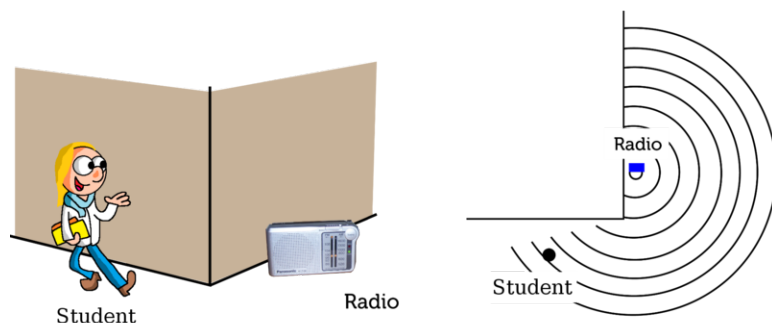

FIGURE 19.18

The person can hear the radio around the corner of the building because of the diffraction of sound waves.

How Diffraction Occurs

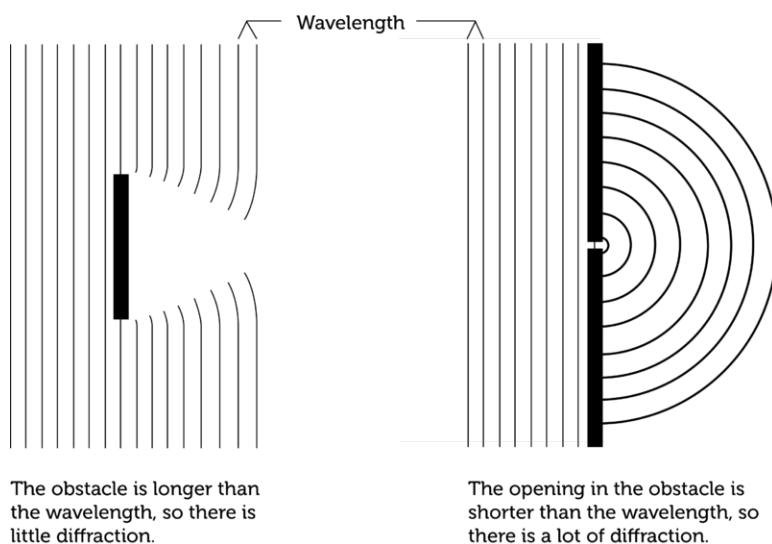

FIGURE 19.19

An obstacle or opening that is shorter than the wavelength causes greater diffraction of waves.

Wave Interference

Waves interact not only with matter in the ways described above. Waves also interact with other waves. This is called **wave interference**. Wave interference may occur when two waves that are traveling in opposite directions meet. The two waves pass through each other, and this affects their amplitude. How amplitude is affected depends on the type of interference. Interference can be constructive or destructive.

Constructive Interference

Constructive interference occurs when the crests of one wave overlap the crests of the other wave. This is illustrated in **Figure 19.20**. As the waves pass through each other, the crests combine to produce a wave with greater amplitude. You can see an animation of constructive interference at this URL: http://phys23p.sl.psu.edu/phys_anim/waves/embedderQ1.20100.html .

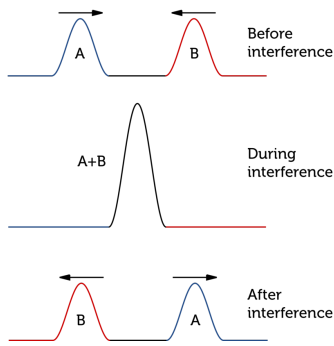
Constructive Interference**FIGURE 19.20**

Constructive interference increases wave amplitude.

Destructive Interference

Destructive interference occurs when the crests of one wave overlap the troughs of another wave. This is illustrated in **Figure 19.21**. As the waves pass through each other, the crests and troughs cancel each other out to produce a wave with less amplitude. You can see an animation of destructive interference at this URL: http://phys23p.sl.psu.edu/phys_anim/waves/embederQ1.20200.html .

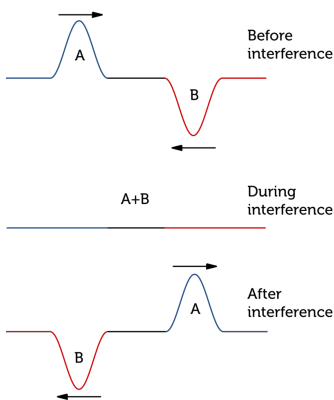
Destructive Interference**FIGURE 19.21**

Destructive interference decreases wave amplitude.

Standing Waves

When a wave is reflected straight back from an obstacle, the reflected wave interferes with the original wave and creates a **standing wave**. This is a wave that appears to be standing still. A standing wave occurs because of a combination of constructive and destructive interference between a wave and its reflected wave. You can see animations of standing waves at the URLs below.

- <http://skullsinthestars.com/2008/05/04/classic-science-paper-otto-wieners-experiment-1890/>
- <http://www.physicsclassroom.com/mmedia/waves/swf.cfm>

It's easy to generate a standing wave in a rope by tying one end to a fixed object and moving the other end up and down. When waves reach the fixed object, they are reflected back. The original wave and the reflected wave interfere to produce a standing wave. Try it yourself and see if the wave appears to stand still.

Lesson Summary

- Reflection occurs when waves bounce back from a barrier they cannot pass through. Refraction occurs when waves bend as they enter a new medium at an angle. Diffraction occurs when waves spread out around an obstacle or after passing through an opening in an obstacle.
- Wave interference occurs when waves interact with other waves. Constructive interference increases wave amplitude. Destructive interference decreases wave amplitude.

Lesson Review Questions

Recall

1. What is reflection? Give an example.
2. Define constructive interference.
3. State how destructive interference affects wave amplitude.
4. What is a standing wave?

Apply Concepts

5. Create a sketch of sound waves to show why you can hear a sound on the other side of brick wall.

Think Critically

6. Explain why the pencil in **Figure 19.17** appears broken.
7. A sound wave meets an obstacle it cannot pass through. Relate the amount of diffraction of the sound wave to the length of the obstacle and the wavelength.

Points to Consider

You were introduced to sound waves in this chapter, and you will learn more about them in the chapter "Sound."

- How do you think we hear sound waves?
- What properties of sound waves might determine how loud a sound is?

19.4 References

1. Tim Fields. <http://www.flickr.com/photos/24327829@N04/6737005997/> . CC BY 2.0
2. Christopher Auyeung. [CK-12 Foundation](#) . CC BY-NC 3.0
3. Christopher Auyeung. [CK-12 Foundation](#) . CC BY-NC 3.0
4. Christopher Auyeung. [CK-12 Foundation](#) . CC BY-NC 3.0
5. Christopher Auyeung. [CK-12 Foundation](#) . CC BY-NC 3.0
6. Christopher Auyeung. [CK-12 Foundation](#) . CC BY-NC 3.0
7. Christopher Auyeung. [CK-12 Foundation](#) . CC BY-NC 3.0
8. User:Vargklo/Wikipedia, modified by CK-12 Foundation. http://commons.wikimedia.org/wiki/File:Wave_motion-i18n.svg . Public Domain
9. Top: U.S. Geological Survey; Bottom: Flickr: Axion23. Top: <http://geomaps.wr.usgs.gov/parks/sea/gwave.html>; Bottom: <http://www.flickr.com/photos/gfreeman23/5137640341/> . Top: Public Domain; Bottom: CC BY 2.0
10. David Rydevik. <http://commons.wikimedia.org/wiki/File:2004-tsunami.jpg> . Public Domain
11. Christopher Auyeung. [CK-12 Foundation](#) .
12. Christopher Auyeung. [CK-12 Foundation](#) .
13. Christopher Auyeung. [CK-12 Foundation](#) .
14. Kyle Taylor. <http://www.flickr.com/photos/kyletaylor/394160033/> . CC BY 2.0
15. Flickr:daveynin. <http://www.flickr.com/photos/daveynin/7130041653/> . CC BY 2.0
16. Christopher Auyeung. [CK-12 Foundation](#) . CC BY-NC 3.0
17. Iain Watson. <http://www.flickr.com/photos/dagoaty/4657318099/> . CC BY 2.0
18. Student: Flickr:MaxTorrt; Radio: Flickr:Kansir. Student: <http://www.flickr.com/photos/16953895@N05/8299424201/>; Radio: <http://www.flickr.com/photos/kansirnet/231639326/> . CC BY 2.0
19. Christopher Auyeung. [CK-12 Foundation](#) . CC BY-NC 3.0
20. Christopher Auyeung. [CK-12 Foundation](#) . CC BY-NC 3.0
21. Christopher Auyeung. [CK-12 Foundation](#) . CC BY-NC 3.0

CHAPTER 20**Sound****Chapter Outline**

- 20.1 CHARACTERISTICS OF SOUND**
 - 20.2 HEARING SOUND**
 - 20.3 USING SOUND**
 - 20.4 REFERENCES**
-



You can almost hear the sound of this colorful African drum! The drummer must be hitting the drum quickly because his hands are a blur of motion. Each time he strikes the drum, it produces a loud, pounding sound. There are hundreds of different kinds of musical instruments, from drums to horns to stringed instruments. Would it surprise you to learn that all of them make sound in the same basic way? Do you know how sounds are created? You'll learn how when you read this chapter.

Image copyright elena moiseeva, 2013. www.shutterstock.com. Used under license from Shutterstock.com.

20.1 Characteristics of Sound

Lesson Objectives

- Describe sound waves.
- Identify properties of sound.

Lesson Vocabulary

- decibel (dB)
- Doppler effect
- infrasound
- intensity
- loudness
- pitch
- sound
- ultrasound

Introduction

The tree in **Figure 20.1** fell to the forest floor in a high wind. Does it make you think of an old riddle? The riddle goes like this:

If a tree falls in the forest and there's no one there to hear it, does it make any sound?

To answer the riddle correctly, you first need to know the scientific definition of sound. In science, **sound** is the transfer of energy from a vibrating object in waves that travel through matter. Most people commonly use the term *sound* to mean what they hear when sound waves enter their ears. The tree creates sound waves when it falls to the ground, so it makes sound according to the scientific definition. But the sound won't be detected by a person's ears if there's no one in the forest. So the answer to the riddle is both yes and no!

Sound Waves

Why does a tree make sound when it crashes to the ground? How does the sound reach people's ears if they happen to be in the forest? And in general, how do sounds get started, and how do they travel? Keep reading to find out.

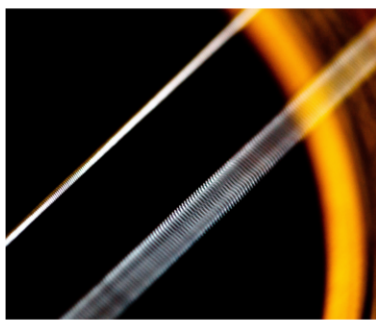

FIGURE 20.1

This tree cracked and fell to the ground in a storm. Can you imagine what it sounded like when it came crashing down?

How Sounds Begin

All sounds begin with vibrating matter. It could be the ground vibrating when a tree comes crashing down. Or it could be guitar strings vibrating when they are plucked. You can see a guitar string vibrating in **Figure 20.2**. The vibrating string repeatedly pushes against the air particles next to it. The pressure of the vibrating string causes these air particles to vibrate. The air particles alternately push together and spread apart. This starts waves of vibrations that travel through the air in all directions away from the strings. The vibrations pass through the air as longitudinal waves, with individual air particles vibrating back and forth in the same direction that the waves travel. You can see an animation of sound waves moving through air at this URL: <http://www.mediacollege.com/audio/01/sound-waves.html> .



A guitar string vibrates back and forth.

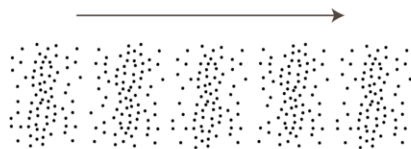

Vibrating air particles pass the energy of the vibrations away from the string in waves.



The sound is heard when the sound waves enter a person's ears.

FIGURE 20.2

Plucking a guitar string makes it vibrate. The vibrating string sends sound waves through the air in all directions.

Sound and Matter

Sound waves are mechanical waves, so they can travel only through matter and not through empty space. This was demonstrated in the 1600s by a scientist named Robert Boyle. Boyle placed a ticking clock in a sealed glass jar. The clock could be heard ticking through the air and glass of the jar. Then Boyle pumped the air out of the jar. The clock was still running, but the ticking could no longer be heard. That's because the sound couldn't travel away from the clock without air particles to pass the sound energy along. You can see an online demonstration of the same experiment—with a modern twist—at this URL: <http://www.youtube.com/watch?v=b0JQt4u6-XI> (4:06).



MEDIA

Click image to the left for more content.

Sound waves can travel through many different kinds of matter. Most of the sounds we hear travel through air, but sounds can also travel through liquids such as water and solids such as glass and metal. If you swim underwater—or even submerge your ears in bathwater—any sounds you hear have traveled to your ears through water. You can tell that sounds travel through glass and other solids because you can hear loud outdoor sounds such as sirens through closed windows and doors.

Properties of Sound

Sound has certain characteristic properties because of the way sound energy travels in waves. Properties of sound include speed, loudness, and pitch.

Speed of Sound

The speed of sound is the distance that sound waves travel in a given amount of time. You probably already know that sound travels more slowly than light. That's why you usually see the flash of lightning before you hear the boom of thunder. However, the speed of sound isn't constant. It varies depending on the medium of the sound waves. **Table 20.1** lists the speed of sound in several different media. Generally, sound waves travel fastest through solids and slowest through gases. That's because the particles of solids are close together and can quickly pass the energy of vibrations to nearby particles. You can explore the speed of sound in different media at this URL: <http://www.ltscotland.org.uk/resources/s/sound/speedofsound.asp?strReferringChannel=resources&strReferringPageID=tcm:4-248291-64> .

TABLE 20.1: The speed of sound depends on the medium.

Medium (20°C)	Speed of Sound Waves (m/s)
Air	343
Water	1437
Wood	3850
Glass	4540
Aluminum	6320

The speed of sound also depends on the temperature of the medium. For a given medium such as air, sound has a slower speed at lower temperatures. You can compare the speed of sound in air at different temperatures in **Table 20.2**. A lower temperature means that particles of the medium are moving more slowly, so it takes them longer to transfer the energy of the sound waves. The amount of water vapor in the air affects the speed of sound as well. Do you think sound travels faster or slower when the air contains more water vapor? (*Hint*: Compare the speed of sound in water and air in **Table 20.1**.)

TABLE 20.2: Based on the values in this table, predict the speed of sound in air at 10°C.

Temperature of Air	Speed of Sound (m/s)
0°C	331
20°C	343
100°C	386

Loudness

A friend whispers to you in class in a voice so soft that you have to lean very close to hear what he’s saying. Later that day, your friend shouts to you across the football field. Now his voice is loud enough for you to hear him clearly even though he’s many meters away. Obviously, sounds can vary in loudness. **Loudness** refers to how loud or soft a sound seems to a listener. The loudness of sound is determined, in turn, by the intensity of sound. **Intensity** is a measure of the amount of energy in sound waves. The unit of intensity is the **decibel (dB)**.

You can see typical decibel levels of several different sounds in **Figure 20.3**. As decibel levels get higher, sound waves have greater intensity and sounds are louder. For every 10-decibel increase in the intensity of sound, loudness is 10 times greater. Therefore, a 30-decibel "quiet" room is 10 times louder than a 20-decibel whisper, and a 40-decibel light rainfall is 100 times louder than a 20-decibel whisper. How much louder than a 20-decibel whisper is the 60-decibel sound of a vacuum cleaner?

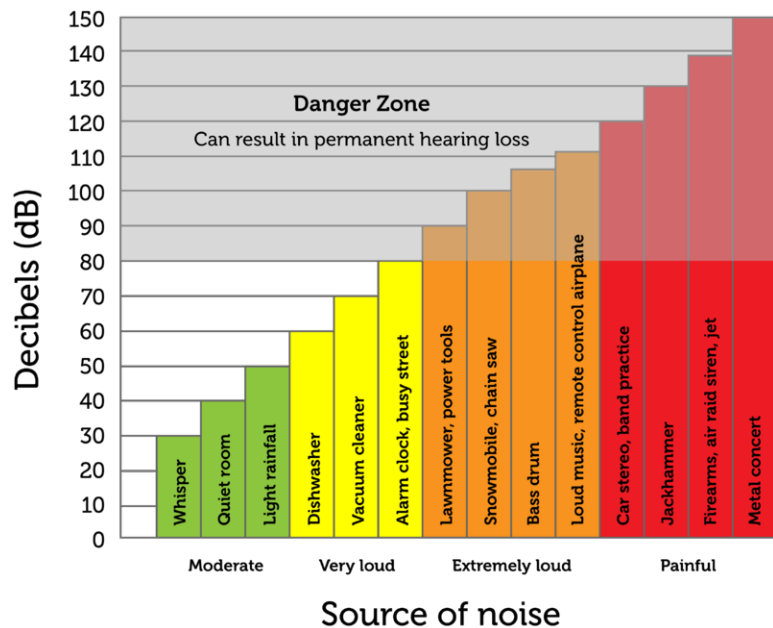
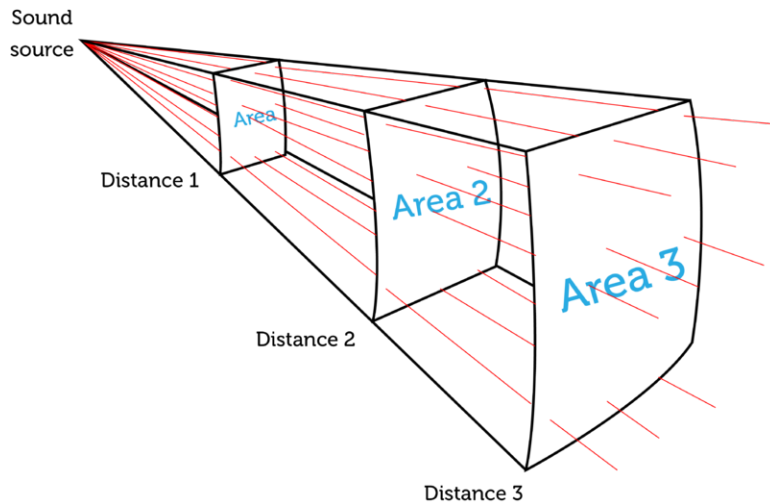

FIGURE 20.3

High-decibel sounds can damage the ears and cause loss of hearing. Which sounds in the graph are dangerously loud?

The intensity of sound waves determines the loudness of sounds, but what determines intensity? Intensity is a function of two factors: the amplitude of the sound waves and how far they have traveled from the source of the

sound. Remember that sound waves start at a source of vibrations and spread out from the source in all directions. The farther the sound waves travel away from the source, the more spread out their energy becomes. This is illustrated in **Figure 20.4**. The decrease in intensity with distance from a sound source explains why even loud sounds fade away as you move farther from the source. It also explains why low-amplitude sounds can be heard only over short distances. For a video demonstration of the amplitude and loudness of sounds, go to this URL: <http://www.youtube.com/watch?v=irqfGYD2UKw> . You can also explore the amplitude of sound waves with the interactive animation at this URL: <http://www.ltscotland.org.uk/resources/s/sound/amplitude.asp?strReferringChannel=resources&strReferringPageID=tcM:4-248294-64> .

FIGURE 20.4

The energy of sound waves spreads out over a greater area as the waves travel farther from the sound source. This diagram represents just a small section of the total area of sound waves spreading out from the source. Sound waves actually travel away from the source in all directions. As distance from the source increases, the area covered by the sound waves increases, lessening their intensity.

Pitch

A marching band is parading down the street. You can hear it coming from several blocks away. When the different instruments finally pass by you, their distinctive sounds can be heard. The tiny piccolos trill their bird-like high notes, and the big tubas rumble out their booming bass notes (see **Figure 20.5**). Clearly, some sounds are higher or lower than others. But do you know why? How high or low a sound seems to a listener is its **pitch**. Pitch, in turn, depends on the frequency of sound waves. Recall that the frequency of waves is the number of waves that pass a fixed point in a given amount of time. High-pitched sounds, like the sounds of a piccolo, have high-frequency waves. Low-pitched sounds, like the sounds of a tuba, have low-frequency waves. For a video demonstration of frequency and pitch, go to this URL: <http://www.youtube.com/watch?v=irqfGYD2UKw> (3:20).



MEDIA

Click image to the left for more content.

To explore an interactive animation of sound wave frequency, go to this URL: <http://www.ltscotland.org.uk/resources/s/sound/amplitude.asp?strReferringChannel=resources&strReferringPageID=tcM:4-248294-64> .

The frequency of sound waves is measured in hertz (Hz), or the number of waves that pass a fixed point in a second. Human beings can normally hear sounds with a frequency between about 20 Hz and 20,000 Hz. Sounds



A piccolo produces high-frequency sound waves and high-pitched sounds.



A tuba produces low-frequency sound waves and low-pitched sounds.



FIGURE 20.5

A piccolo and a tuba sound very different. One difference is the pitch of their sounds.

with frequencies below 20 hertz are called **infrasound**. Sounds with frequencies above 20,000 hertz are called **ultrasound**. Some other animals can hear sounds in the ultrasound range. For example, dogs can hear sounds with frequencies as high as 50,000 Hz. You may have seen special whistles that dogs but not people can hear. The whistles produce a sound with a frequency too high for the human ear to detect. Other animals can hear even higher-frequency sounds. Bats, for example, can hear sounds with frequencies higher than 100,000 Hz.

Doppler Effect

Look at the police car in **Figure 20.6**. The sound waves from its siren travel outward in all directions. Because the car is racing forward (toward the right), the sound waves get bunched up in front of the car and spread out behind it. As the car approaches the person on the right (position B), the sound waves get closer and closer together. In other words, they have a higher frequency. This makes the siren sound higher in pitch. After the car speeds by the person on the left (position A), the sound waves get more and more spread out, so they have a lower frequency. This makes the siren sound lower in pitch. A change in the frequency of sound waves, relative to a stationary listener, when the source of the sound waves is moving is called the **Doppler effect**. You've probably experienced the Doppler effect yourself. The next time a vehicle with a siren races by, listen for the change in pitch. For an online animation of the Doppler effect, go to the URL below.

<http://www.astro.ubc.ca/~scharein/a311/Sim/doppler/Doppler.html>

Lesson Summary

- Sound is the transfer of energy from a vibrating object in waves that travel through matter.
- Properties of sound include speed, loudness, and pitch. The speed of sound varies in different media. The

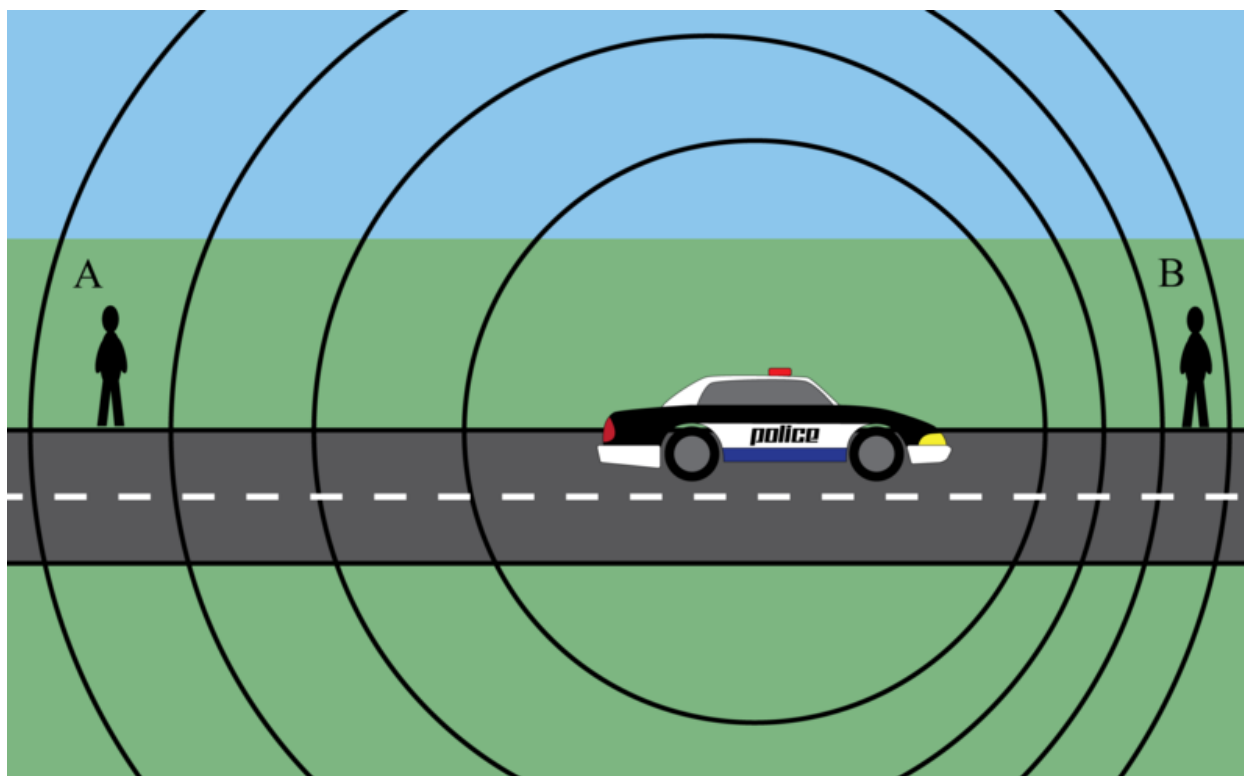
**FIGURE 20.6**

The siren's pitch changes as the police car zooms by. Can you explain why?

loudness of sound depends on the intensity of sound waves. The pitch of sound depends on the frequency of sound waves.

Lesson Review Questions

Recall

1. How is sound defined in physics?
2. Identify two factors that determine the intensity of sound.
3. What is the pitch of sound?

Apply Concepts

4. A wind chime produces both high-pitched and low-pitched sounds. If you could see the sound waves from the wind chime, what would they look like?
5. Look back at **Figure 20.6**. Does the siren change pitch to the police officer driving the car? Why or why not?

Think Critically

6. Explain why sound tends to travel faster in solids than in liquids or gases.

Points to Consider

In this lesson you learned that high-intensity, high-amplitude sound waves make dangerously loud sounds. In the next lesson, "Hearing Sound," you'll read how loud sounds can cause loss of hearing.

- How do you think loud sounds cause hearing loss?
- What can you do to protect your ears from loud sounds?

20.2 Hearing Sound

Lesson Objectives

- Explain how we hear sound.
- Relate loud sounds to hearing loss.
- State how hearing can be protected.

Introduction

The organ that we use to hear sound is the ear. Almost all the structures in the ear are needed for this purpose. Together, they gather and amplify sound waves and change their energy to electrical signals. The electrical signals travel to the brain, which interprets them as sound.

How We Hear

Figure 20.7 shows the three main parts of the ear: the outer, middle, and inner ear. It also shows the specific structures in each part. The roles of these structures in hearing are described below and in the animations at these URLs:

- http://www.medindia.net/animation/ear_anatomy.asp
- <http://www.youtube.com/watch?v=pCCcFDoyBxM> (1:43)

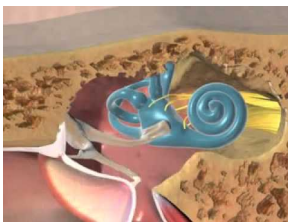

MEDIA

Click image to the left for more content.

Outer Ear

The outer ear includes the pinna, ear canal, and eardrum.

- The pinna is the only part of the ear that extends outward from the head. Its position and shape make it good at catching sound waves and funneling them into the ear canal.
- The ear canal is a tube that carries sound waves into the ear. The sound waves travel through the air inside the ear canal to the eardrum.

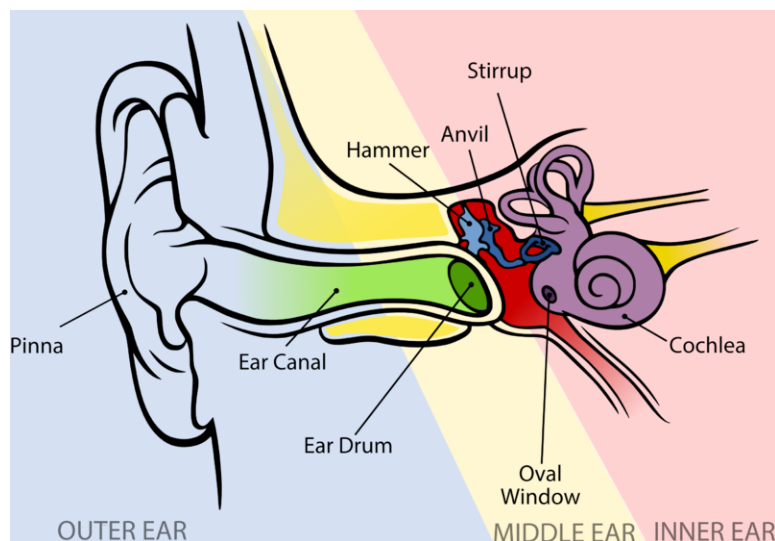

FIGURE 20.7

The three main parts of the ear have different functions in hearing.

- The eardrum is like the head of a drum. It's a thin membrane stretched tight across the end of the ear canal. The eardrum vibrates when sound waves strike it, and it sends the vibrations on to the middle ear.

Middle Ear

The middle ear contains three tiny bones (ossicles) called the hammer, anvil, and stirrup. If you look at these bones in **Figure 20.7**, you might notice that they resemble the objects for which they are named. The three bones transmit vibrations from the eardrum to the inner ear. They also amplify the vibrations. The arrangement of the three bones allows them to work together as a lever that increases the amplitude of the waves as they pass to the inner ear.

Inner Ear

The stirrup passes the amplified sound waves to the inner ear through the oval window (see **Figure 20.7**). When the oval window vibrates, it causes the cochlea to vibrate as well. The cochlea is a shell-like structure that is full of fluid and lined with nerve cells called hair cells. Each hair cell has tiny hair-like projections, as you can see in **Figure 20.8**. When the cochlea vibrates, it causes waves in the fluid inside. The waves bend the "hairs" on the hair cells, and this triggers electrical impulses. The electrical impulses travel to the brain through nerves. Only after the nerve impulses reach the brain do we hear the sound.

Hearing Loss

All these structures of the ear must work well for normal hearing. Damage to any of them, through illness or injury, may cause hearing loss. Total hearing loss is called deafness. To learn more about hearing loss, watch the animation at this URL: <http://www.youtube.com/watch?v=YpIptQSEEjY> (1:39).

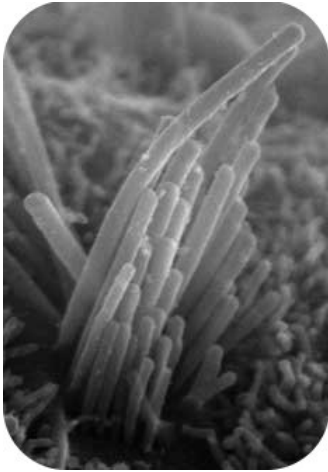
**FIGURE 20.8**

This highly magnified image of a hair cell shows the tiny hair-like structures on its surface. What function do the "hairs" play in hearing?

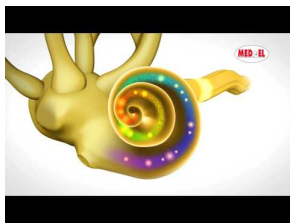
**MEDIA**

Click image to the left for more content.

Most adults experience at least some hearing loss as they get older. The most common cause is exposure to loud sounds, which damage hair cells. The louder a sound is, the less exposure is needed for damage to occur. Even a single brief exposure to a sound louder than 115 decibels can cause hearing loss. **Figure 20.9** shows the relationship between loudness, exposure time, and hearing loss.

Loudness of Sounds and Exposure Times

Continuous dB	Permissible Exposure Time
85 dB	8 Hours
88 dB	4 Hours
91 dB	2 Hours
94 dB	1 Hour
97 dB	30 minutes
100 dB	15 minutes
103 dB	7.5 minutes
106 dB	< 4 minutes
109 dB	< 2 minutes
112 dB	~ 1 minute
115 dB	~ 30 seconds

FIGURE 20.9

The louder the sounds are, the less time you should be exposed to them for the sake of your hearing.

Preventing Hearing Loss

Hearing loss caused by loud sounds is permanent. However, this type of hearing loss can be prevented by protecting the ears from loud sounds.

Who Needs Hearing Protection?

People who work in jobs that expose them to loud sounds must wear hearing protectors. Examples include construction workers who work around loud machinery for many hours each day (see **Figure 20.10**). But anyone exposed to loud sounds for longer than the permissible exposure time should wear hearing protectors. Many home and yard chores and even recreational activities are loud enough to cause hearing loss if people are exposed to them for very long.



FIGURE 20.10

Many activities expose people to dangerously loud sounds that can cause hearing loss.



Construction sites and factories are often dangerously loud. In the U.S., employers are required by law to warn workers of dangerous sound levels and provide them with proper hearing protection.

If you use a lawn mower, you should protect your ears from the noise of the engine, which may reach 90 decibels.

If you ride a snowmobile, you should protect your ears from the noise of the engine. It may reach 100 decibels.

How Hearing Protectors Work

You can see two different types of hearing protectors in **Figure 20.11**. Earplugs are simple hearing protectors that just muffle sounds by partially blocking all sound waves from entering the ears. This type of hearing protector is suitable for lower noise levels, such as the noise of a lawnmower or snowmobile engine.

Electronic ear protectors work differently. They identify high-amplitude sound waves and send sound waves through them in the opposite direction. This causes destructive interference with the waves, which reduces their amplitude to zero or nearly zero. This changes even the loudest sounds to just a soft hiss. Sounds that people need to hear,

such as the voices of co-workers, are not interfered with in this way and may be amplified instead so they can be heard more clearly. This type of hearing protector is recommended for higher noise levels and situations where it's important to be able to hear lower-decibel sounds.

Earplugs are made of polyurethane foam, silicon, or a similar material that sound waves do not readily pass through. They mold to the inside of the ear canal to prevent most sound waves from passing through to the eardrum.



Electronic hearing protectors use a microphone (1) to listen to noise (2) coming into the ears.

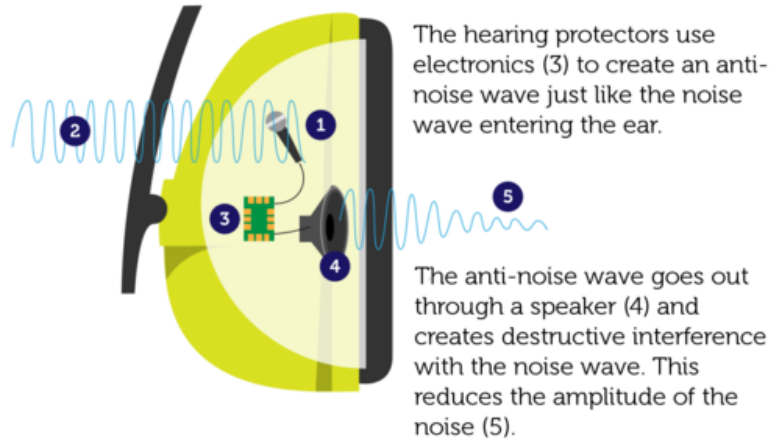

FIGURE 20.11

All types of hearing protectors help reduce the risk of hearing loss, but they don't all work the same way.

Lesson Summary

- The outer ear catches sound waves and funnels them to the middle ear. The middle ear amplifies the sound waves and passes them to the inner ear. The inner ear changes the sound waves to electrical signals. The signals travel to the brain, which interprets the sounds.
- Loud sounds can cause hearing loss by damaging hair cells in the inner ear. The louder the sounds are, the less exposure is needed to cause hearing loss.
- Hearing loss due to loud sounds can be prevented by wearing hearing protectors. They reduce the amplitude of sound waves entering the ears.

Lesson Review Questions

Recall

1. What is the function of the outer ear?
2. How does the middle ear amplify sound?
3. Describe the structure of the cochlea.
4. State how hair cells detect sound waves.

Apply Concepts

5. Write a public service announcement warning people of the dangers of loud sounds. Include tips for protecting the ears from loud sounds.

Think Critically

6. In **Figure 20.9**, how are permissible exposure times related to sound intensity? Create a graph to show the relationship.

Points to Consider

In this lesson, you read about loud sounds and their dangers. Rock concerts often produce very loud sounds. Both the screaming fans and the highly amplified musical instruments contribute to the high decibel levels. Playing musical instruments is one way we use sound. You'll read about musical instruments in "Using Sound," the next lesson.

- How do you think musical instruments produce sound? In other words, how do you think they cause air to vibrate?
- How do musical instruments change the pitch of sound?

20.3 Using Sound

Lesson Objectives

- Explain how musical instruments produce sound.
- Identify uses of ultrasound.

Lesson Vocabulary

- resonance
- sonar

Introduction

If you have normal hearing, it's hard to imagine life without sound. A silent world would seem like an eerie place. Sound is an important part of how we sense the world around us. Whether it's the chirping of a bird, the sigh of a friend, or the whistle of a train, sound gives us important clues about our environment. We also depend on sound to communicate and for many other purposes. One very pleasant way we use sound is to make music.

Making Music

People have been using sound to make music for thousands of years. They have invented many different kinds of musical instruments for this purpose. Despite their diversity, however, musical instruments share certain similarities.

- All musical instruments create sound by causing matter to vibrate. The vibrations start sound waves moving through the air.
- Most musical instruments use resonance to amplify the sound waves and make the sounds louder. **Resonance** occurs when an object vibrates in response to sound waves of a certain frequency. In a musical instrument such as a guitar, the whole instrument and the air inside it may vibrate when a single string is plucked. This causes constructive interference with the sound waves, which increases their amplitude.
- Most musical instruments have a way of changing the frequency of the sound waves they produce. This changes the pitch of the sounds.

There are three basic categories of musical instruments: percussion, wind, and stringed instruments. In **Figure 20.12**, you can see how instruments in each category make sound and how the pitch of the sound can be changed.



Percussion Instrument: Drum

A drum makes sound when the musician strikes the skin stretched across the top with hands, sticks, or mallets. The vibrating skin starts the air inside the drum vibrating, which amplifies the sound. Smaller drums produce higher-frequency sound waves, so the sounds are higher pitched. Tightening the skin on a drum also raises the pitch of the sounds it produces.

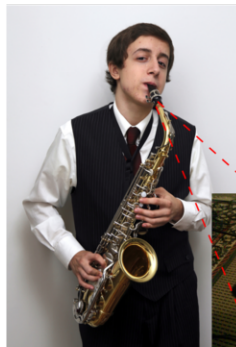

Wind Instrument: Saxophone

A saxophone makes sound when the musician blows across a thin wooden reed on the mouthpiece (see photo below). The vibrating reed starts the column of air inside the saxophone vibrating, which amplifies the sound. Opening or closing holes on the sides of the saxophone changes the length of the vibrating air column. This changes the frequency of the sound waves and the pitch of the sounds.



Thin, wooden reed

String Instrument: Violin



A violin makes sound when the musician either plucks the strings or rubs a bow across them. The vibrating strings start the rest of the violin and the air inside it vibrating. This amplifies the sound. Pressing down on a string with a finger of the other hand shortens the part of the string that can vibrate. This increases the frequency of the sound waves and raises the pitch of the sound.

FIGURE 20.12

A drum, saxophone, and violin represent the three basic categories of musical instruments. Can you name other instruments in each category?

Using Ultrasound

Ultrasound has frequencies higher than the human ear can detect (higher than 20,000 hertz). Although we can't hear ultrasound, it is very useful. Uses include echolocation, sonar, and ultrasonography.

Echolocation

Animals such as bats, whales, and dolphins send out ultrasound waves and use their echoes, or reflected waves, to identify the locations of objects they cannot see. This is called echolocation. Animals use echolocation to find prey and avoid running into objects in the dark. **Figure 20.13** and the animation at the URL below show how a bat uses echolocation to locate insect prey.

http://www.bsos.umd.edu/psyc/batlab/headaimmovies/nsf_challenge/nsf4.wmv

Sonar

Sonar uses ultrasound in a way that is similar to echolocation. **Sonar** stands for **s**ound **n**avigation and **r**anging. It is used to locate underwater objects such as sunken ships or to determine how deep the water is. A sonar device is usually located on a boat at the surface of the water. The device is both a sender and a receiver (see **Figure 20.14**). It sends out ultrasound waves and detects reflected waves that bounce off underwater objects or the bottom of the water. If you watch the video at the URL below, you can see how sonar is used on a submarine.

<http://dsc.discovery.com/videos/ultimate-guide-to-submarines-sonar.html>

The distance to underwater objects or the bottom of the water can be calculated from the known speed of sound in

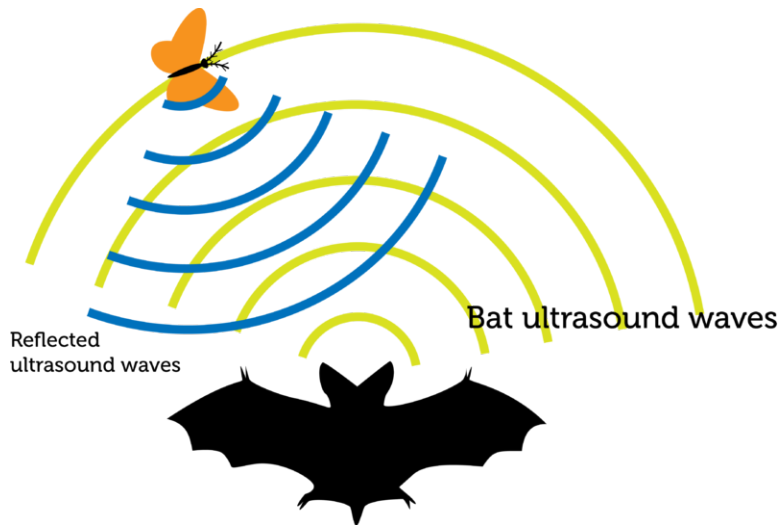

FIGURE 20.13

Bats use ultrasound to find prey.

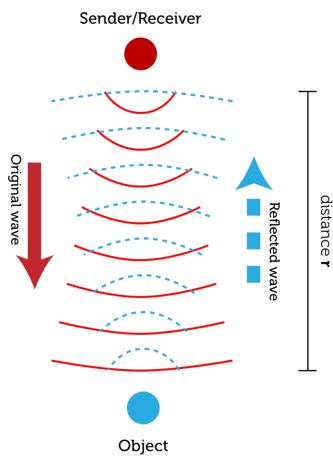

FIGURE 20.14

Sonar works on the same principle as echolocation.

water and the time it takes for the waves to travel to the object. The equation for the calculation is:

$$\text{Distance} = \text{Speed} \times \text{Time}$$

Assume, for example, that a sonar device on a ship sends an ultrasound wave to the bottom of the ocean. The speed of the sound through ocean water is 1437 m/s, and the wave travels to the bottom and back in 2 seconds. What is the distance from the surface to the bottom of the water? The sound wave travels to the bottom and back in 2 seconds, so it travels from the surface to the bottom in 1 second. Therefore, the distance from the surface to the bottom is:

$$\text{Distance} = 1437 \text{ m/s} \times 1 \text{ s} = 1437 \text{ m}$$

You Try It!

Problem: The sonar device on a ship sends an ultrasound wave to the bottom of the water at speed of 1437 m/s. The wave is reflected back to the device in 4 seconds. How deep is the water?

Ultrasonography

Ultrasound can be used to "see" inside the human body. This use of ultrasound is called ultrasonography. Harmless ultrasound waves are sent inside the body, and the reflected waves are used to create an image on a screen. This technology is used to examine internal organs and unborn babies without risk to the patient. You can see an ultrasound image in **Figure 20.15**. You can see an animation showing how ultrasonography works at this URL: <http://health.howstuffworks.com/pregnancy-and-parenting/pregnancy/fetal-development/adam-200128.htm> .



FIGURE 20.15

This ultrasound image shows an unborn baby inside its mother's body. Do you see the baby's face?

Lesson Summary

- All musical instruments make sound by causing something to vibrate and starting sound waves moving through the air. Most instruments use resonance to amplify the sound waves. Most also have a way to change pitch of the sounds. There are three categories of musical instruments: percussion, wind, and stringed instruments.
- Ultrasound has frequencies higher than the human ear can hear. Uses of ultrasound include echolocation, sonar, and ultrasonography.

Lesson Review Questions

Recall

1. Describe ultrasound.
2. How does resonance occur? Give an example.
3. What does sonar stand for?
4. List two uses of sonar.
5. What is ultrasonography?

Apply Concepts

6. Create a sketch to show how a whale might use echolocation to locate a school of fish.

Think Critically

7. Compare and contrast echolocation, sonar, and ultrasonography.

Points to Consider

In this chapter, you read about sound waves, which start with a disturbance of matter and travel through matter as longitudinal waves. In the chapter "Electromagnetic Radiation," you'll read about electromagnetic waves, such as light and X rays, which can travel through empty space.

- How do you think electromagnetic waves might be different from waves that travel through matter?
- How do you think electromagnetic waves get started?

20.4 References

1. Mark Hillary. <http://www.flickr.com/photos/markhillary/361796692/> . CC BY 2.0
2. Guitar string photo by Flickr:jar(); illustration by Christopher Auyeung (CK-12 Foundation). **Guitar string photo:** <http://www.flickr.com/photos/jariceiii/5343236121/> . CC BY 2.0
3. Christopher Auyeung. [CK-12 Foundation](#) . CC BY-NC 3.0
4. Christopher Auyeung. [CK-12 Foundation](#) . CC BY-NC 3.0
5. Piccolo: U.S. Navy photo by Chief Mass Communication Specialist David Rush; Tuba: Bob Fishbeck. **Piccolo:** http://commons.wikimedia.org/wiki/File:US_Navy_081024-N-0879R-007_A_musician_from_the_U.S._Pacific_Fleet_Band_plays_a_piccolo.jpg ; Tuba: http://commons.wikimedia.org/wiki/File:Armen_tuba2.jpg . Public Domain
6. Zachary Wilson. [CK-12 Foundation](#) . CC BY-NC 3.0
7. Original by Chittka L, Brockmann A; modified by CK-12 Foundation. http://commons.wikimedia.org/wiki/File:Anatomy_of_the_Human_Ear.svg . CC BY 2.5
8. S. Heller and K. Oshima. http://www.nidcd.nih.gov/news/releases/10/Pages/07_02_10.aspx . Public Domain
9. Christopher Auyeung. [CK-12 Foundation](#) . CC BY-NC 3.0
10. Sign: Rae Allen; Construction: Photo by John Messina for the Environmental Protection Agency; Lawnmower: Elliot Brown; Snowmobile: Chris Costes; composite by CK-12. **Sign:** <http://www.flickr.com/photos/raeallen/5798295550/>; **Construction:** http://commons.wikimedia.org/wiki/File:AVONDALE_SHIPYARD_WORKER_WEAR_SPECIAL_EAR_MUFFS_FOR_PROTECTION_FROM_THE_HEAVY_LEVEL_OF_INDUSTRIAL_NOISE_POLLUTION_-_NARA_-_546041.jpg; **Lawnmower:** <http://www.flickr.com/photos/ell-r-brown/8830469870/>; **Snowmobile:** <http://www.flickr.com/photos/33852688@N08/3304923489/> . Sign, Lawnmower, Snowmobile: CC BY 2.0; Construction: Public Domain
11. Earplugs: Kevin Dooley; Diagram by Christopher Auyeung (CK-12 Foundation). **Earplugs:** <http://www.flickr.com/photos/pagedooley/3976260597/> . Earplugs: CC BY 2.0; Diagram: CC BY-NC 3.0
12. Drum: Vladimir Morozov; Saxophone player: Flickr:Jim, the Photographer; Sax reed: Daniel Means (Flickr:supapedro); Violin player: Jim Wall (Flickr:silkolive). **Drum:** <http://www.flickr.com/photos/27429206@N02/4124370796/>; **Saxophone player:** <http://www.flickr.com/photos/jcapaldi/9540998932/>; **Sax reed:** http://www.flickr.com/photos/supa_pedro/4296626215/; **Violin player:** <http://www.flickr.com/photos/jimwall/4783029667/> . CC BY 2.0
13. Christopher Auyeung, using bat image by User:Rugby471/Wikimedia Commons. [CK-12 Foundation](#) (bat available at http://commons.wikimedia.org/wiki/File:Bat_shadow_black.svg) . CC BY-NC 3.0 (bat image available under public domain)
14. Christopher Auyeung. [CK-12 Foundation](#) . CC BY-NC 3.0
15. Glenn J. Mason (Flickr:glennji). <http://www.flickr.com/photos/glennji/5566389372/> . CC BY 2.0

CHAPTER 21 Electromagnetic Radiation

Chapter Outline

- 21.1 ELECTROMAGNETIC WAVES
- 21.2 PROPERTIES OF ELECTROMAGNETIC WAVES
- 21.3 THE ELECTROMAGNETIC SPECTRUM
- 21.4 REFERENCES

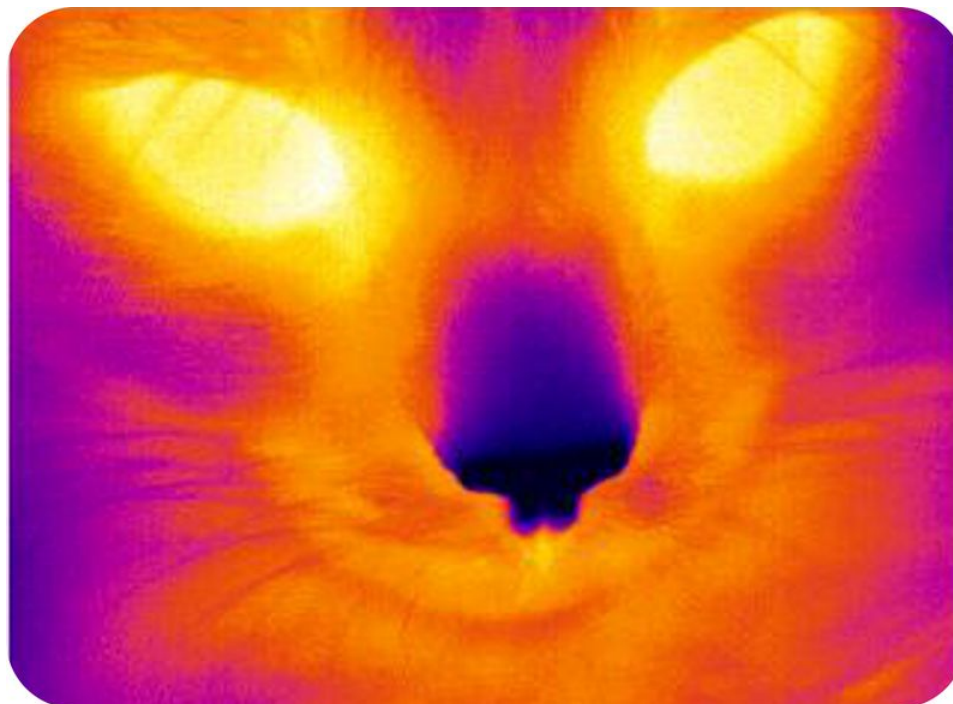

Why is this picture of a cat so colorful? No cat looks like this to the human eye. The picture was taken with a special camera that senses infrared light. This is a form of energy given off by warm objects. Areas that appear yellow are the warmest, and areas that appear purple are the coolest. The picture shows that the cat's eyes are the warmest part of its head. Why can't people see images like this without a camera? The answer has to do with the wavelengths of infrared light. Its wavelengths are too long for the human eye to detect. In fact, the human eye can detect light only in a very narrow range of wavelengths, called visible light. You'll learn more about infrared light, visible light, and other forms of electromagnetic radiation in this chapter.

Flickr:yellowcloud. www.flickr.com/photos/yellowcloud/6375882963/. CC BY 2.0.

21.1 Electromagnetic Waves

Lesson Objectives

- Describe electromagnetic waves.
- Explain how electromagnetic waves begin.
- State how electromagnetic waves travel.
- Summarize the wave-particle theory of light.
- Identify sources of electromagnetic waves.

Lesson Vocabulary

- electromagnetic radiation
- electromagnetic wave
- photon

Introduction

Both infrared light and visible light are examples of electromagnetic radiation. **Electromagnetic radiation** is the transfer of energy by waves traveling through matter or across empty space. The waves that transfer this energy are called electromagnetic waves. In this lesson, you'll learn how electromagnetic waves differ from mechanical waves such as ocean waves and sound waves. For an excellent video introduction to electromagnetic waves, go to this URL: <http://www.youtube.com/watch?v=cfXzwh3KadE> (5:20).



MEDIA

Click image to the left for more content.

What Are Electromagnetic Waves?

An **electromagnetic wave** is a wave that consists of vibrating electric and magnetic fields. A familiar example will help you understand the fields that make up an electromagnetic wave. Think about a common bar magnet. It exerts magnetic force in an area surrounding it, called the magnetic field. You can see the magnetic field of a bar magnet in **Figure 21.1**. Because of this force field, a magnet can exert force on objects without touching them. They just have to be in its magnetic field. An electric field is similar to a magnetic field (see **Figure 21.1**). An electric field is

an area of electrical force surrounding a charged particle. Like a magnetic field, an electric field can exert force on objects over a distance without actually touching them.

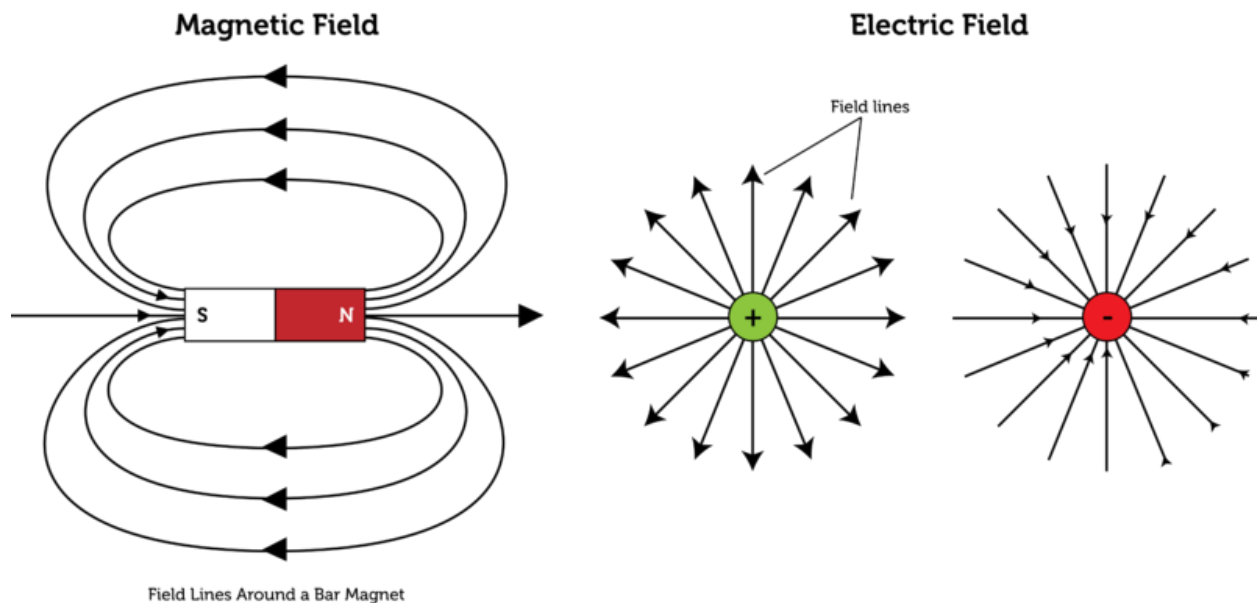
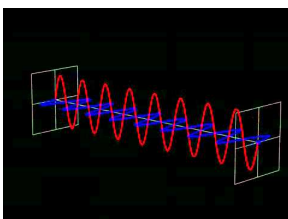

FIGURE 21.1

Magnetic and electric fields are invisible areas of force surrounding magnets and charged particles. The field lines in the diagrams represent the direction and location of the force.

How Electromagnetic Waves Begin

An electromagnetic wave begins when an electrically charged particle vibrates. This is illustrated in **Figure 21.2**. When a charged particle vibrates, it causes the electric field surrounding it to vibrate as well. A vibrating electric field, in turn, creates a vibrating magnetic field (you can learn how this happens in the chapter "Electromagnetism"). The two types of vibrating fields combine to create an electromagnetic wave. You can see an animation of an electromagnetic wave at this URL: <http://www.youtube.com/watch?v=Qju7QnbrOhM> (1:31).



MEDIA

Click image to the left for more content.

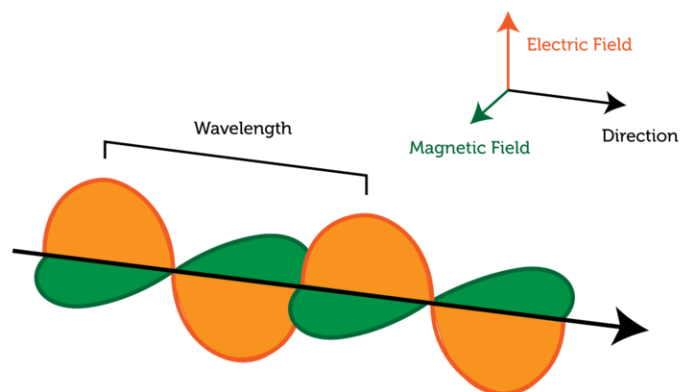
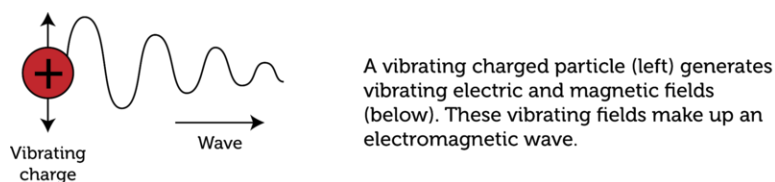
**FIGURE 21.2**

An electromagnetic wave starts with a vibrating charged particle.

How Electromagnetic Waves Travel

As you can see in **Figure 21.2**, the electric and magnetic fields that make up an electromagnetic wave occur at right angles to each other. Both fields are also at right angles to the direction that the wave travels. Therefore, an electromagnetic wave is a transverse wave.

No Medium Required

Unlike a mechanical transverse wave, which requires a medium, an electromagnetic transverse wave can travel through space without a medium. Waves traveling through a medium lose some energy to the medium. However, when an electromagnetic wave travels through space, no energy is lost, so the wave doesn't get weaker as it travels. However, the energy is "diluted" as it spreads out over an ever-larger area as it travels away from the source. This is similar to the way a sound wave spreads out and becomes less intense farther from the sound source.

Wave Interactions

Electromagnetic waves can travel through matter as well as across space. When they strike matter, they interact with it in the same ways that mechanical waves interact with matter. They may reflect (bounce back), refract (bend when traveling through different materials), or diffract (bend around objects). They may also be converted to other forms of energy. Microwaves are a familiar example. They are a type of electromagnetic wave that you can read about later on in this chapter, in the lesson "The Electromagnetic Spectrum." When microwaves strike food in a microwave oven, they are converted to thermal energy, which heats the food.

Wave or Particle?

Electromagnetic radiation behaves like waves of energy most of the time, but sometimes it behaves like particles. As evidence accumulated for this dual nature of electromagnetic radiation, the famous physicist Albert Einstein

developed a new theory about electromagnetic radiation, called the wave-particle theory. This theory explains how electromagnetic radiation can behave as both a wave and a particle. In brief, when an electron returns to a lower energy level, it is thought to give off a tiny "packet" of energy called a **photon** (see **Figure 21.3**). The amount of energy in a photon may vary. It depends on the frequency of electromagnetic radiation. The higher the frequency is, the more energy a photon has.

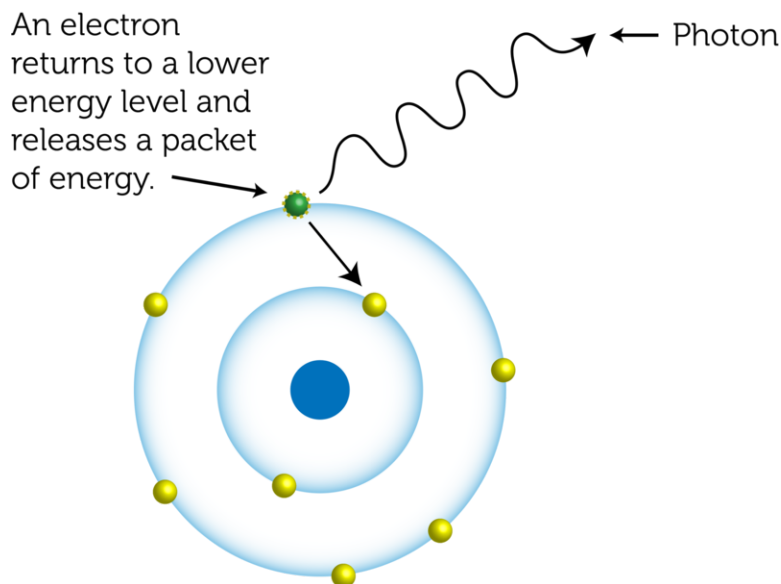
**FIGURE 21.3**

A photon of light energy is given off when an electron returns to a lower energy level.

Sources of Electromagnetic Radiation

The most important source of electromagnetic radiation on Earth is the sun. Electromagnetic waves travel from the sun to Earth across space and provide virtually all the energy that supports life on our planet. Many other sources of electromagnetic waves that people use depend on technology. Radio waves, microwaves, and X rays are examples. We use these electromagnetic waves for communications, cooking, medicine, and many other purposes. You'll learn about all these types of electromagnetic waves in this chapter's lesson on "The Electromagnetic Spectrum."

Lesson Summary

- An electromagnetic wave consists of vibrating electric and magnetic fields.
- An electromagnetic wave begins when an electrically charged particle vibrates.
- Electromagnetic waves are transverse waves that can travel across space without a medium. When the waves strike matter, they may reflect, refract, or diffract, or they may be converted to other forms of energy.
- Electromagnetic radiation behaves like particles as well as waves. This prompted Albert Einstein to develop his wave-particle theory.
- The most important source of electromagnetic waves on Earth is the sun, which provides virtually all the energy that supports life on Earth. Other sources of electromagnetic radiation depend on technology and are used for communications, cooking, and other purposes.

Lesson Review Questions

Recall

1. Define electromagnetic radiation.
2. What is an electromagnetic wave?
3. How do electromagnetic waves interact with matter?
4. What is a photon?
5. Identify sources of electromagnetic waves.

Apply Concepts

6. Create a diagram to represent an electromagnetic wave. Explain your diagram to another student who has no prior knowledge of electromagnetic waves.

Think Critically

7. Explain how an electromagnetic wave begins.
8. Compare and contrast mechanical transverse waves and electromagnetic transverse waves.

Points to Consider

In this lesson, you learned that electromagnetic waves are transverse waves. Like other transverse waves, electromagnetic waves have certain properties.

- Based on your knowledge of other transverse waves, such as waves in a rope, what is the wavelength of an electromagnetic wave? How is it measured?
- How do you think the wavelengths of electromagnetic waves are related to their frequencies? (*Hint: How is the speed of waves calculated?*)

21.2 Properties of Electromagnetic Waves

Lesson Objectives

- Describe the speed of electromagnetic waves.
- Relate wavelength and frequency of electromagnetic waves.

Lesson Vocabulary

- speed of light

Introduction

Some electromagnetic waves are harmless. The light we use to see is a good example. Other electromagnetic waves are very harmful. They can penetrate virtually anything and destroy living cells. Why do electromagnetic waves vary in these ways? It depends on their properties. Like other waves, electromagnetic waves have properties of speed, wavelength, and frequency.

Speed of Electromagnetic Waves

All electromagnetic waves travel at the same speed through empty space. That speed, called the **speed of light**, is 300 million meters per second (3.0×10^8 m/s). Nothing else in the universe is known to travel this fast. If you could move that fast, you would be able to travel around Earth 7.5 times in just 1 second! The sun is about 150 million kilometers (93 million miles) from Earth, but it takes electromagnetic radiation only 8 minutes to reach Earth from the sun. Electromagnetic waves travel more slowly through a medium, and their speed may vary from one medium to another. For example, light travels more slowly through water than it does through air (see **Figure 21.4**). You can learn more about the speed of light at this URL: <http://videos.howstuffworks.com/discovery/29407-assignment-discovery-speed-of-light-video.htm> .

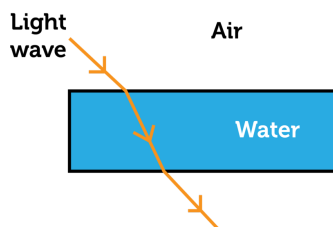

FIGURE 21.4

Light slows down when it enters water from the air. This causes the wave to refract, or bend.

Wavelength and Frequency of Electromagnetic Waves

Although all electromagnetic waves travel at the same speed, they may differ in their wavelength and frequency.

Defining Wavelength and Frequency

Wavelength and frequency are defined in the same way for electromagnetic waves as they are for mechanical waves. Both properties are illustrated in **Figure 21.5**.

- Wavelength is the distance between corresponding points of adjacent waves. Wavelengths of electromagnetic waves range from many kilometers to a tiny fraction of a millimeter.
- Frequency is the number of waves that pass a fixed point in a given amount of time. Frequencies of electromagnetic waves range from thousands to trillions of waves per second. Higher frequency waves have greater energy.

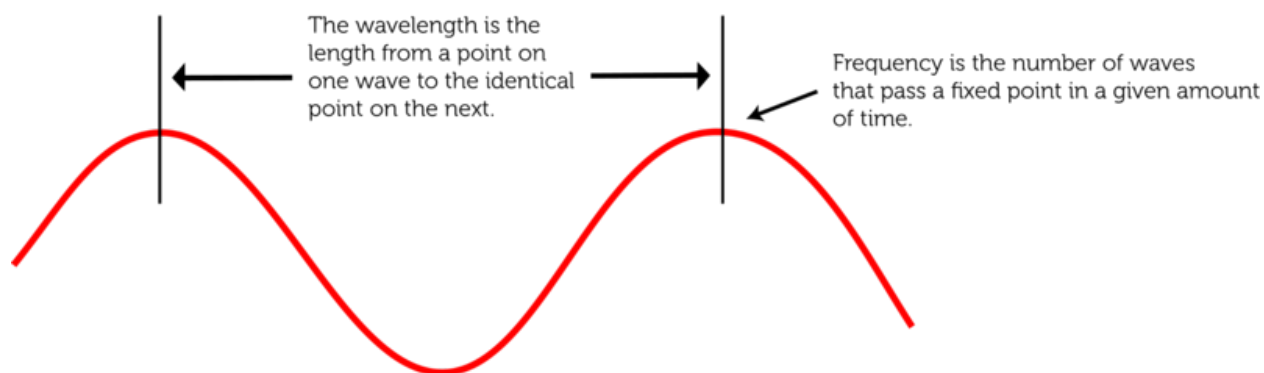

FIGURE 21.5

Wavelength and frequency of electromagnetic waves.

Speed, Wavelength, and Frequency

The speed of a wave is a product of its wavelength and frequency. Because all electromagnetic waves travel at the same speed through space, a wave with a shorter wavelength must have a higher frequency, and vice versa. This relationship is represented by the equation:

$$\text{Speed} = \text{Wavelength} \times \text{Frequency}$$

The equation for wave speed can be rewritten as:

$$\text{Frequency} = \frac{\text{Speed}}{\text{Wavelength}} \text{ or } \text{Wavelength} = \frac{\text{Speed}}{\text{Frequency}}$$

Therefore, if either wavelength or frequency is known, the missing value can be calculated. Consider an electromagnetic wave that has a wavelength of 3 meters. Its speed, like the speed of all electromagnetic waves, is 3.0×10^8 meters per second. Its frequency can be found by substituting these values into the frequency equation:

$$\text{Frequency} = \frac{3.0 \times 10^8 \text{ m/s}}{3.0 \text{ m}} = 1.0 \times 10^8 \text{ waves/s, or } 1.0 \times 10^8 \text{ hertz (Hz)}$$

You Try It!

Problem: What is the wavelength of an electromagnetic wave that has a frequency of 3.0×10^8 hertz?

For more practice calculating the frequency and wavelength of electromagnetic waves, go to these URLs:

- <http://www.youtube.com/watch?v=GwZvtfZRNKk>
- <http://www.youtube.com/watch?v=wjPk108Ua8k>

Lesson Summary

- All electromagnetic waves travel at the same speed through space, called the speed of light, which equals 3.0×10^8 meters per second. Electromagnetic waves travel more slowly through a medium.
- Electromagnetic waves differ in their wavelengths and frequencies. The higher the frequency of an electromagnetic wave, the greater its energy. The speed of an electromagnetic wave is the product of its wavelength and frequency, so a wave with a shorter wavelength has a higher frequency, and vice versa.

Lesson Review Questions

Recall

1. What is the speed of light?
2. What is the wavelength of an electromagnetic wave?
3. Describe the range of frequencies of electromagnetic waves.

Apply Concepts

4. If an electromagnetic wave has a wavelength of 1 meter, what is its frequency?

Think Critically

5. Explain why light waves bend when they pass from air to water at an angle.
6. Explain the relationship between frequency and wavelength of electromagnetic waves.

Points to Consider

In this lesson, you learned that electromagnetic waves vary in their wavelength and frequency. The complete range of wavelengths and frequencies of electromagnetic waves is outlined in the next lesson, "The Electromagnetic

Spectrum."

- What do you think are the longest-wavelength electromagnetic wave?
- What might be the electromagnetic waves with the highest frequencies?

21.3 The Electromagnetic Spectrum

Lesson Objectives

- Define the electromagnetic spectrum.
- Describe radio waves and their uses.
- Identify three forms of light.
- Describe X rays and gamma rays.

Lesson Vocabulary

- electromagnetic spectrum
- gamma ray
- infrared light
- microwave
- radar
- radio wave
- ultraviolet light
- visible light
- X ray

Introduction

Imagine playing beach volleyball, like the young men in **Figure 21.6**. They may not realize it, but they are being bombarded by electromagnetic radiation as play in the sunlight. The only kinds of radiation they can detect are visible light, which allows them to see, and infrared light, which they feel as warmth on their skin. What other kinds of electromagnetic radiation are they being exposed to in sunlight? In this lesson, you'll find out.

What Is The Electromagnetic Spectrum?

Electromagnetic radiation occurs in waves of different wavelengths and frequencies. Infrared light and visible light make up just a small part of the full range of electromagnetic radiation, which is called the **electromagnetic spectrum**. The electromagnetic spectrum is summarized in the diagram in **Figure 21.7**.

- On the far left of the diagram are radio waves, which include microwaves. They have the longest wavelengths and lowest frequencies of all electromagnetic waves. They also have the least amount of energy.
- On the far right are X rays and gamma rays. They have the shortest wavelengths and highest frequencies of all electromagnetic waves. They also have the greatest amount of energy.

**FIGURE 21.6**

Electromagnetic radiation from the sun reaches Earth across space. It strikes everything on Earth's surface, including these volleyball players.

- Between these two extremes, wavelength, frequency, and energy change continuously from one side of the spectrum to the other. Waves in this middle section of the electromagnetic spectrum are commonly called light.

As you will read below, the properties of electromagnetic waves influence how the different waves behave and how they can be used.

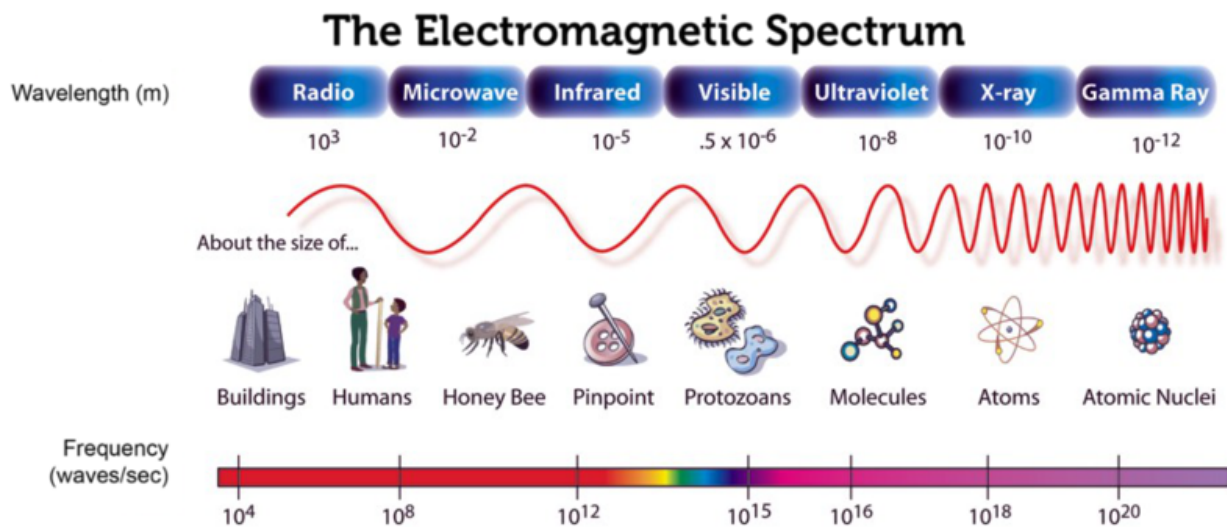
**FIGURE 21.7**

How do the wavelength and frequency of waves change across the electromagnetic spectrum?

Radio Waves

Radio waves are the broad range of electromagnetic waves with the longest wavelengths and lowest frequencies. In **Figure 21.7**, you can see that the wavelength of radio waves may be longer than a soccer field. With their low frequencies, radio waves have the least energy of electromagnetic waves, but they still are extremely useful. They are used for radio and television broadcasts, microwave ovens, cell phone transmissions, and radar. You can learn more about radio waves, including how they were discovered, at this URL: <http://www.youtube.com/watch?v=a17sFP4C2TY> (3:58).

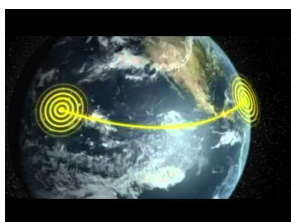

MEDIA

Click image to the left for more content.

AM and FM Radio

In radio broadcasts, sounds are encoded in radio waves that are sent out through the atmosphere from a radio tower. A receiver detects the radio waves and changes them back to sounds. You've probably listened to both AM and FM radio stations. How sounds are encoded in radio waves differs between AM and FM broadcasts.

- AM stands for amplitude modulation. In AM broadcasts, sound signals are encoded by changing the amplitude of radio waves. AM broadcasts use longer-wavelength radio waves than FM broadcasts. Because of their longer wavelengths, AM radio waves reflect off a layer of the upper atmosphere called the ionosphere. You can see how this happens in **Figure 21.8**. This allows AM radio waves to reach radio receivers that are very far away from the radio tower.
- FM stands for frequency modulation. In FM broadcasts, sound signals are encoded by changing the frequency of radio waves. Frequency modulation allows FM waves to encode more information than does amplitude modulation, so FM broadcasts usually sound clearer than AM broadcasts. However, because of their shorter wavelength, FM waves do not reflect off the ionosphere. Instead, they pass right through it and out into space (see **Figure 21.8**). As a result, FM waves cannot reach very distant receivers.

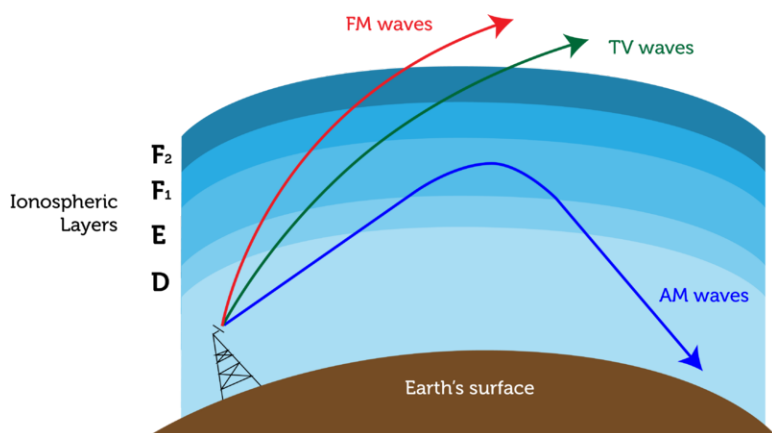

FIGURE 21.8

AM radio waves reflect off the ionosphere and travel back to Earth. Radio waves used for FM radio and television pass through the ionosphere and do not reflect back.

Television

Television broadcasts also use radio waves. Sounds are encoded with frequency modulation, and pictures are encoded with amplitude modulation. The encoded radio waves are broadcast from a TV tower like the one in **Figure 21.9**. When the waves are received by television sets, they are decoded and changed back to sounds and pictures.

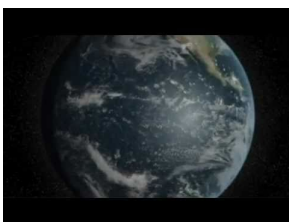

FIGURE 21.9

This television tower broadcasts signals using radio waves.

Microwaves

The shortest wavelength, highest frequency radio waves are called **microwaves** (see **Figure 21.7**). Microwaves have more energy than other radio waves. That's why they are useful for heating food in microwave ovens. Microwaves have other important uses as well, including cell phone transmissions and **radar**, which is a device for determining the presence and location of an object by measuring the time for the echo of a radio wave to return from it and the direction from which it returns. These uses are described in **Figure 21.10**. You can learn more about microwaves and their uses in the video at this URL: <http://www.youtube.com/watch?v=YgQQb1BVnu8> (3:23).



MEDIA

Click image to the left for more content.

Light

Mid-wavelength electromagnetic waves are commonly called light. This range of electromagnetic waves has shorter wavelengths and higher frequencies than radio waves, but not as short and high as X rays and gamma rays. Light includes visible light, infrared light, and ultraviolet light. If you look back at **Figure 21.7**, you can see where these different types of light waves fall in the electromagnetic spectrum.

Visible Light

The only light that people can see is called **visible light**. It refers to a very narrow range of wavelengths in the electromagnetic spectrum that falls between infrared light and ultraviolet light. Within the visible range, we see light

Cell Phones

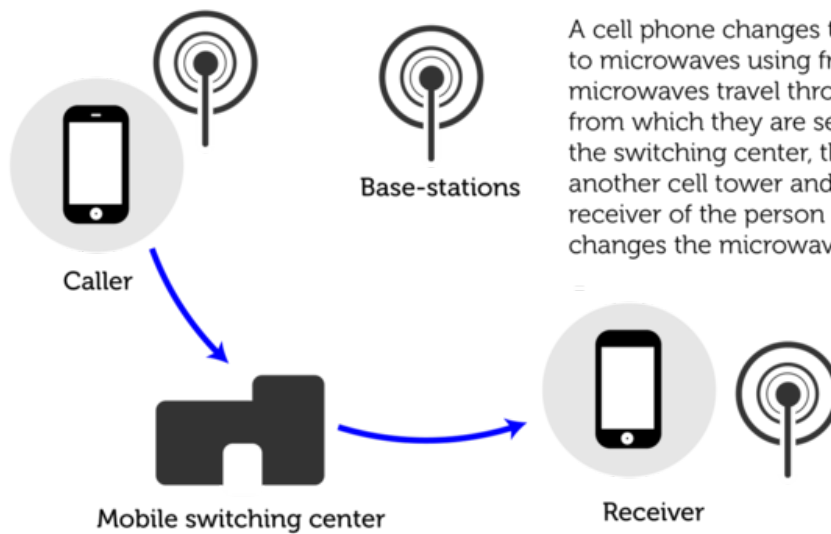

A cell phone changes the sounds of the caller's voice to microwaves using frequency modulation. The microwaves travel through the air to a cell tower, from which they are sent to a switching center. From the switching center, the microwaves are sent to another cell tower and from the tower to the receiver of the person being called. The receiver changes the microwaves back to sounds.

Radar

Radar stands for radio detection and ranging. In police radar, a radar gun in a police car sends out short bursts of microwaves. The microwaves reflect back from oncoming cars. The time it takes for the microwaves to return to the radar gun is used to compute the speed of oncoming cars. Radar is also used for tracking storms, detecting air traffic, and other purposes.

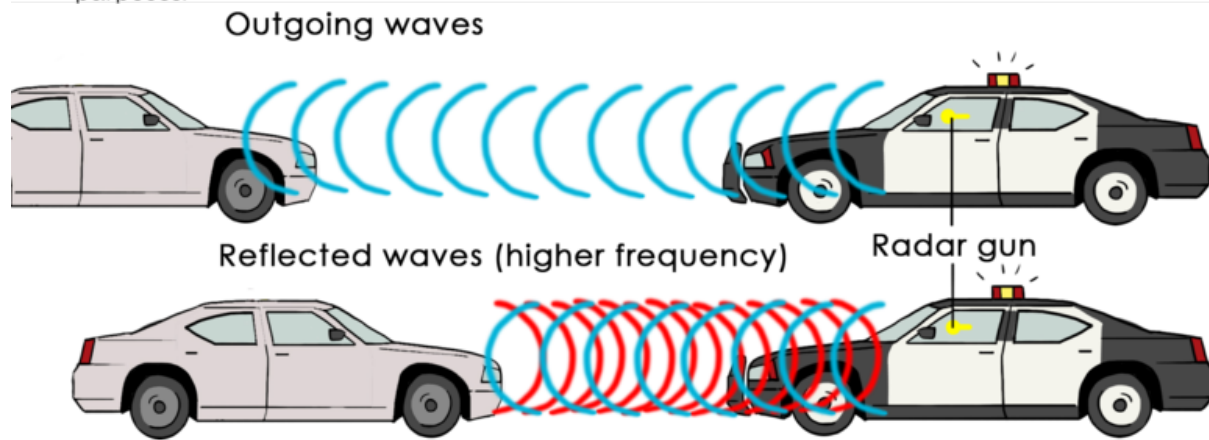
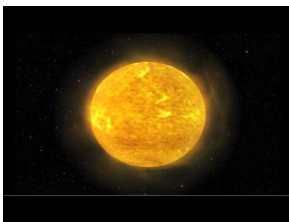

FIGURE 21.10

Microwaves are used for cell phones and radar.

of different wavelengths as different colors of light, from red light, which has the longest wavelength, to violet light, which has the shortest wavelength. You can see the spectrum of colors of visible light in **Figure 21.11**. When all of the wavelengths are combined, as they are in sunlight, visible light appears white. You can learn more about visible light in the chapter "Visible Light" and at the URL below.

<http://www.youtube.com/watch?v=PMtC34pzKGc> (4:50)



MEDIA

Click image to the left for more content.



FIGURE 21.11

Red light (right) has the longest wavelength, and violet light (left) has the shortest wavelength.

Infrared Light

Light with the longest wavelengths is called **infrared light**. The term *infrared* means "below red." Infrared light is the range of light waves that have longer wavelengths than red light in the visible spectrum. You can't see infrared light waves, but you can feel them as heat on your skin. The sun gives off infrared light as do fires and living things. The picture of a cat that opened this chapter was made with a camera that detects infrared light waves and changes their energy to colored light in the visible range. Night vision goggles, which are used by law enforcement and the military, also detect infrared light waves. The goggles convert the invisible waves to visible images. For a deeper understanding of infrared light, watch the video at this URL: <http://www.youtube.com/watch?v=2-0q0XIQJO> (6:46).



MEDIA

Click image to the left for more content.

Ultraviolet Light

Light with wavelengths shorter than visible light is called **ultraviolet light**. The term *ultraviolet* means "above violet." Ultraviolet light is the range of light waves that have shorter wavelengths than violet light in the visible spectrum. Humans can't see ultraviolet light, but it is very useful nonetheless. It has higher-frequency waves than visible light, so it has more energy. It can be used to kill bacteria in food and to sterilize laboratory equipment (see **Figure 21.12**). The human skin also makes vitamin D when it is exposed to ultraviolet light. Vitamin D is needed for strong bones and teeth. You can learn more about ultraviolet light and its discovery at this URL: <http://www.youtube.com/watch?v=QW5zeVy8aE0> (3:40).



MEDIA

Click image to the left for more content.

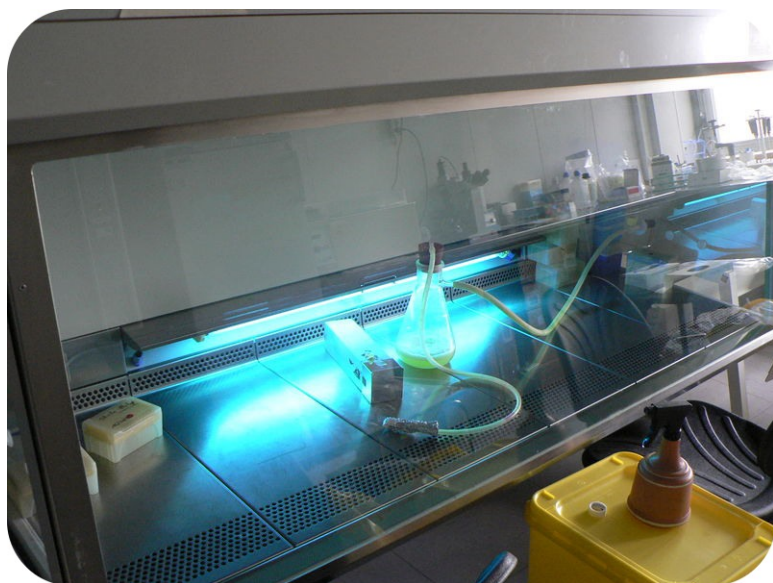

FIGURE 21.12

This sterilizer for laboratory equipment uses ultraviolet light to kill bacteria.

Too much exposure to ultraviolet light can cause sunburn and skin cancer. You can protect your skin from ultraviolet light by wearing clothing that covers your skin and by applying sunscreen to any exposed areas. The SPF, or sun-protection factor, of sunscreen gives a rough idea of how long it protects the skin from sunburn (see **Figure 21.13**). A sunscreen with a higher SPF protects the skin longer. You should use sunscreen with an SPF of at least 15 even on cloudy days, because ultraviolet light can travel through clouds. Sunscreen should be applied liberally and often. You can learn more about the effects of ultraviolet light on the skin at this URL: <http://www.youtube.com/watch?v=np-BBJyl-go> (5:59).



MEDIA

Click image to the left for more content.

X Rays and Gamma Rays

The shortest-wavelength, highest-frequency electromagnetic waves are X rays and gamma rays. These rays have so much energy that they can pass through many materials. This makes them potentially very harmful, but it also makes them useful for certain purposes.



FIGURE 21.13

If your skin normally burns in 10 minutes of sun exposure, using sunscreen with an SPF of 30 means that, ideally, your skin will burn only after 30 times 10 minutes, or 300 minutes, of sun exposure. How long does sunscreen with an SPF of 50 protect skin from sunburn?

X Rays

X rays are high-energy electromagnetic waves. They have enough energy to pass through soft tissues such as skin but not enough to pass through bones and teeth, which are very dense. The bright areas on the X ray film in **Figure 21.14** show where X rays were absorbed by the teeth. X rays are used not only for dental and medical purposes but also to screen luggage at airports (see **Figure 21.14**). Too much X ray exposure may cause cancer. If you've had dental X rays, you may have noticed that a heavy apron was placed over your body to protect it from stray X rays. The apron is made of lead, which X rays cannot pass through. You can learn about the discovery of X rays as well as other uses of X rays at this URL: <http://www.guardian.co.uk/science/blog/2010/oct/26/x-ray-visions-disease-for-geries> .

Dental X ray



Airport X ray

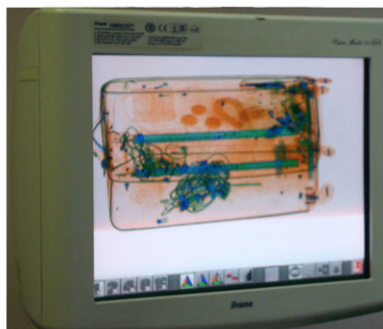

FIGURE 21.14

Two common uses of X rays are illustrated here.

Gamma Rays

Gamma rays are the most energetic of all electromagnetic waves. They can pass through most materials, including bones and teeth. Nonetheless, even these waves are useful. For example, they can be used to treat cancer. A medical device sends gamma rays the site of the cancer, and the rays destroy the cancerous cells. If you want to learn more about gamma rays, watch the video at the URL below.

<http://www.youtube.com/watch?v=okyynBaSOtA> (2:45)



MEDIA

Click image to the left for more content.

Lesson Summary

- The electromagnetic spectrum is the full range of wavelengths and frequencies of electromagnetic radiation. Wavelength, frequency, and energy change continuously across the electromagnetic spectrum.
- Radio waves are the broad range of electromagnetic waves with the longest wavelengths and lowest frequencies. They are used for radio and television broadcasts, microwave ovens, cell phone transmissions, and radar.
- Mid-wavelength electromagnetic waves are called light. Light consists of visible, infrared, and ultraviolet light. Humans can see only visible light. Infrared light has longer wavelengths than visible light and is perceived as warmth. Ultraviolet light has shorter wavelengths than visible light and has enough energy to kill bacteria. It can also harm the skin.
- X rays and gamma rays are the electromagnetic waves with the shortest wavelengths and highest frequencies. X rays are used in medicine and dentistry and to screen luggage at airports. Gamma rays are used to kill cancer cells.

Lesson Review Questions

Recall

1. What is the electromagnetic spectrum?
2. Describe how wave frequency changes across the electromagnetic spectrum, from radio waves to gamma rays.
3. List three uses of radio waves.
4. How are X rays and gamma rays used in medicine?

Apply Concepts

5. Create a public service video warning people of the dangers of ultraviolet light. Include tips for protecting the skin from ultraviolet light.

Think Critically

6. Explain two ways that sounds can be encoded in electromagnetic waves.
7. Explain how radar works.
8. Compare and contrast infrared, visible, and ultraviolet light.

Points to Consider

This chapter introduces visible light. The chapter "Visible Light" discusses visible light in greater detail.

- In this lesson, you read that visible light consists of light of different colors. Do you know how visible light can be separated into its different colors? (*Hint*: How does a rainbow form?)
- In the next chapter, *Visible Light*, you'll read that visible light interacts with matter in certain characteristic ways. Based on your own experiences with visible light, how does it interact with matter? (*Hint*: What happens to visible light when it strikes a wall, window, or mirror?)

21.4 References

1. Christopher Auyeung. [CK-12 Foundation](#) . CC BY-NC 3.0
2. Christopher Auyeung. [CK-12 Foundation](#) . CC BY-NC 3.0
3. Christopher Auyeung. [CK-12 Foundation](#) . CC BY-NC 3.0
4. Christopher Auyeung. [CK-12 Foundation](#) . CC BY-NC 3.0
5. Christopher Auyeung. [CK-12 Foundation](#) . CC BY-NC 3.0
6. Alicia Bruce. <http://www.flickr.com/photos/aliciaabruce/6883325921/> . CC BY 2.0
7. Courtesy of NASA. http://commons.wikimedia.org/wiki/File:EM_Spectrum3-new.jpg . Public Domain
8. Christopher Auyeung. [CK-12 Foundation](#) . CC BY-NC 3.0
9. KaMa Photography. http://www.flickr.com/photos/katharina_90/3858883369/ . CC BY 2.0
10. Christopher Auyeung and Laura Guerin. [CK-12 Foundation](#) . CC BY-NC 3.0
11. User:Phrood/Wikimedia Commons. <http://commons.wikimedia.org/wiki/File:Spectrum-sRGB.svg> . Public Domain
12. User:Newbie/Wikimedia Commons. http://commons.wikimedia.org/wiki/File:UV-ontsmetting_laminaire-vloekast.JPG . Public Domain
13. Tom Newby. <http://www.flickr.com/photos/noodle93/5392321454/> . CC BY 2.0
14. Dental X ray: Paulo Ordoveza (Flickr:brownpau); Airport X ray: Gwydion M. Williams. [Dental X ray: http://www.flickr.com/photos/brownpau/4879544448/](#); [Airport X ray: http://www.flickr.com/photos/45909111@N00/3766521804/](#) . CC BY 2.0

CHAPTER 22**Visible Light****Chapter Outline**

- 22.1 THE LIGHT WE SEE**
 - 22.2 OPTICS**
 - 22.3 VISION**
 - 22.4 REFERENCES**
-



There is no pot of gold at the end of this rainbow, but it's pretty special nonetheless. Rainbows don't form very often, and they usually don't last very long. Maybe because they are relatively rare or because they often signal the end of a rainstorm, some people think rainbows are a sign of good luck. You may have noticed that rainbows form when the sun starts to come out while raindrops are still falling. What do the sun and raindrops have to do with rainbows? In this chapter, you'll find out.

Martina Rathgens. www.flickr.com/photos/riviera2008/5176587882/. CC BY 2.0.

22.1 The Light We See

Lesson Objectives

- Identify common sources of visible light.
- Explain how light interacts with matter.
- Describes the colors of visible light.

Lesson Vocabulary

- absorption
- incandescence
- luminescence
- opaque
- pigment
- primary color
- scattering
- translucent
- transmission
- transparent

Introduction

We can see rainbows because they are formed by visible light. Visible light includes all the wavelengths of light that the human eye can detect. It allows us to see objects in the world around us. Without visible light, we would only be able to sense most objects by sound or touch, and we would never see rainbows. Like humans, most other organisms also depend on visible light, either directly or indirectly. Many animals use it to see. All plants use it to make food in the process of photosynthesis. Without the food made by plants, most other organisms could not survive.

Sources of Visible Light

Look at the classroom in **Figure 22.1**. It has several sources of visible light. One source of visible light is the sun. Sunlight enters the classroom through the windows. The sun provides virtually all of the visible light that living things need. Visible light travels across space from the sun to Earth in electromagnetic waves. But how does the sun produce light? Read on to find out.

**FIGURE 22.1**

This classroom has two obvious sources of visible light. Can you identify all of them?

How Visible Light Is Produced

The sun and other stars produce light because they are so hot. They glow with light due to their extremely high temperatures. This way of producing light is called **incandescence**. Some objects produce light without becoming very hot. They generate light through chemical reactions or other processes. Producing light without heat is called **luminescence**. Objects that produce light by luminescence are said to be luminous. Luminescence, in turn, can occur in different ways:

- One type of luminescence is called fluorescence. In this process, a substance absorbs shorter-wavelength light, such as ultraviolet light, and then gives off light in the visible range of wavelengths. Certain minerals produce light in this way.
- Another type of luminescence is called electroluminescence. In this process, a substance gives off light when an electric current runs through it. Some gases produce light in this way.
- A third type of luminescence is called bioluminescence. This is the production of light by living things as a result of chemical reactions. Examples of bioluminescent organisms are pictured in **Figure 22.2**. You can learn more about bioluminescence in the video at this URL: http://www.ted.com/talks/edith_widder_glowing_life_in_an_underwater_world.html .

Many other objects appear to produce their own light, but they actually just reflect light from another source. The moon is a good example. It appears to glow in the sky from its own light, but in reality it is just reflecting light from the sun. Objects like the moon that are lit up by another source of light are said to be illuminated. Everything you can see that doesn't produce its own light is illuminated.

Jellyfish

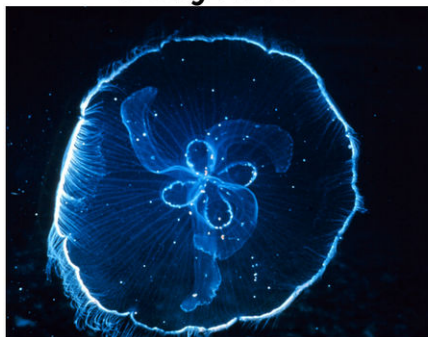

Firefly

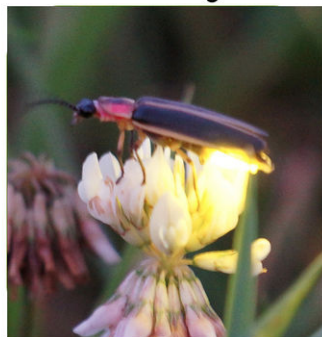

FIGURE 22.2

Bioluminescent organisms include jellyfish and fireflies. Jellyfish give off visible light to startle predators. Fireflies give off visible light to attract mates.

Artificial Lights

The classroom in **Figure 22.1** has artificial light sources in addition to natural sunlight. There are fluorescent lights on the ceiling of the room. There are also projectors on the ceiling that are shining light on screens. In these and most other artificial light sources, electricity provides the energy and some type of light bulb converts the electrical energy to visible light. How a light bulb produces visible light varies by type of bulb, as you can see in **Table 22.1**. Incandescent light bulbs, which produce light by incandescence, give off a lot of heat as well as light, so they waste energy. Other light bulbs produce light by luminescence, so they produce little if any heat. These light bulbs use energy more efficiently. Which types of light bulbs do you use?

TABLE 22.1: Different types of light bulbs produce visible light in different ways.





Type of Light Bulb	Description
<p>Incandescent Light</p> 	<p>An incandescent light bulb produces visible light by incandescence. The bulb contains a thin wire filament made of tungsten. When electric current passes through the filament, it gets extremely hot and glows. You can learn more about incandescent light bulbs at the URL below.</p> <p>http://science.discovery.com/videos/deconstructed-how-incandescent-light-bulbs-work.html</p>
<p>Fluorescent Light</p> 	<p>A fluorescent light bulb produces visible light by fluorescence. The bulb contains mercury gas that gives off ultraviolet light when electricity passes through it. The inside of the bulb is coated with a substance called phosphor. The phosphor absorbs the ultraviolet light and then gives off most of the energy as visible light. You can learn more about fluorescent light bulbs at this URL: http://science.discovery.com/videos/deconstructed-compact-fluorescent-light-bulb.html .</p>

TABLE 22.1: (continued)

Type of Light Bulb	Description
Neon Light 	<p>A neon light produces visible light by electroluminescence. The bulb is a glass tube that contains the noble gas neon. When electricity passes through the gas, it excites electrons of neon atoms, causing them to give off visible light. Neon produces red light. Other noble gases are also used in lights, and they produce light of different colors. For example, krypton produces violet light, and argon produces blue light.</p>
Vapor Light 	<p>A vapor light produces visible light by electroluminescence. The bulb contains a small amount of solid sodium or mercury as well as a mixture of neon and argon gases. When an electric current passes through the gases, it causes the solid sodium or mercury to change to a gas and emit visible light. Sodium vapor lights, like these streetlights, produce yellowish light. Mercury vapor lights produce bluish light. Vapor lights are very bright and energy efficient. The bulbs are also long lasting.</p>
LED Light 	<p>LED stands for “light-emitting diode.” This type of light contains a material, called a semi-conductor, which gives off visible light when a current runs through it. LED lights are used for traffic lights and indicator lights on computers, cars, and many other devices. This type of light is very reliable and durable.</p>

Light and Matter

When visible light strikes matter, it interacts with it. How light interacts with matter depends on the type of matter.

How Light Interacts with Matter

Light may interact with matter in several ways.

- Light may be reflected by matter. Reflected light bounces back when it strikes matter. Reflection of light is similar to reflection of sound waves. You can read more about reflection of light later on in this chapter in the lesson “Optics.”
- Light may be refracted by matter. The light is bent when it passes from one type of matter to another. Refraction of light is similar to refraction of sound waves. You can also read more about refraction of light in

the lesson “Optics.”

- Light may pass through matter. This is called **transmission** of light. As light is transmitted, it may be scattered by particles of matter and spread out in all directions. This is called **scattering** of light.
- Light may be absorbed by matter. This is called **absorption** of light. When light is absorbed, it doesn't reflect from or pass through matter. Instead, its energy is transferred to particles of matter, which may increase the temperature of matter.

Classifying Matter in Terms of Light

Matter can be classified on the basis of how light interacts with it. Matter may be transparent, translucent, or opaque. Each type of matter is illustrated in **Figure 22.3**.

- **Transparent** matter is matter that transmits light without scattering it. Examples of transparent matter include air, pure water, and clear glass. You can see clearly through a transparent object, such as the revolving glass doors in the figure, because all the light passes straight through it.
- **Translucent** matter is matter that transmits but scatters light. Light passes through a translucent object but you cannot see clearly through the object because the light is scattered in all directions. The frosted glass doors in the figure are translucent.
- **Opaque** matter is matter that does not let any light pass through it. Matter may be opaque because it absorbs light, reflects light, or does both. Examples of opaque objects are solid wooden doors and glass mirrors. A wooden door absorbs most of the light that strikes it and reflects just a few wavelengths of visible light. A mirror, which is a sheet of glass with a shiny metal coating on the back, reflects all the light that strikes it.

Colors of Light

Visible light consists of a range of wavelengths. The wavelength of visible light determines the color that the light appears. As you can see in **Figure 22.4**, light with the longest wavelength appears red, and light with the shortest wavelength appears violet. In between is a continuum of all the other colors of light. Only a few colors of light are represented in the figure.

Separating Colors of Light

A prism, like the one in **Figure 22.5**, can be used to separate visible light into its different colors. A prism is a pyramid-shaped object made of transparent matter, usually clear glass. It transmits light but slows it down. When light passes from the air to the glass of the prism, the change in speed causes the light to bend. Different wavelengths of light bend at different angles. This causes the beam of light to separate into light of different wavelengths. What we see is a rainbow of colors. Look back at the rainbow that opened this chapter. Do you see all the different colors of light, from red at the top to violet at the bottom? Individual raindrops act as tiny prisms. They separate sunlight into its different wavelengths and create a rainbow.

For an animated version of **Figure 22.5**, go to the URL: http://en.wikipedia.org/wiki/File:Light_dispersion_conceptual_waves.gif .

Colors of Objects

We see an opaque object, such as the apple in **Figure 22.6**, because it reflects some wavelengths of visible light. The wavelengths that are reflected determine the color that the object appears. For example, the apple in the figure appears red because it reflects red light and absorbs light of other wavelengths. We see a transparent or translucent object,

Transparent: Clear Glass Doors



Translucent: Frosted Glass Doors



Opaque: Wooden Door



Opaque: Glass Mirror

**FIGURE 22.3**

The objects pictured here differ in the way light interacts with them.

such as the bottle in **Figure 22.6**, because it transmits light. The wavelength of the transmitted light determines the color that the object appears. For example, the bottle in the figure appears blue because it transmits blue light.

The color of light that strikes an object may also affect the color that the object appears. For example, if only blue light strikes a red apple, the blue light is absorbed and no light is reflected. When no light reflects from an object, it looks black. Black isn't a color. It is the absence of light.

The Colors We See

The human eye can distinguish only red, green, and blue light. These three colors of light are called **primary colors**. All other colors of light can be created by combining the primary colors. As you can see in **Figure 22.7**, when red and green light combine, they form yellow. When red and blue light combine, they form magenta, a dark pinkish color, and when blue and green light combine, they form cyan, a bluish green color. Yellow, magenta, and cyan are called the secondary colors of light. Look at the center of the diagram in **Figure 22.7**. When all three primary colors combine, they form white light. White is the color of the full spectrum of visible light when all of its wavelengths are combined. You can explore the colors of visible light and how they combine with the interactive animations at this URL: http://www.phy.ntnu.edu.tw/oldjava/color/color_e.html .

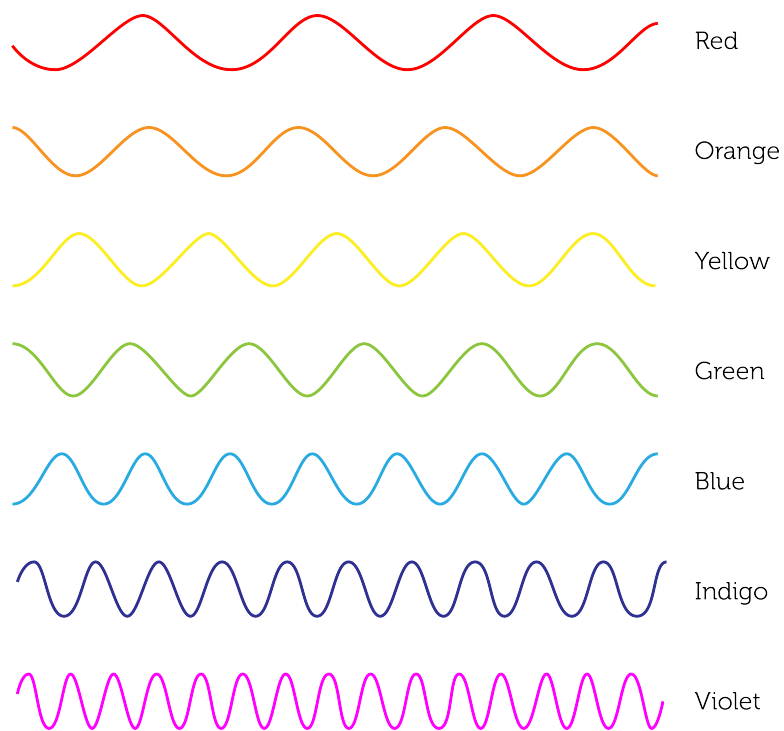

FIGURE 22.4

The color of light depends on its wavelength.

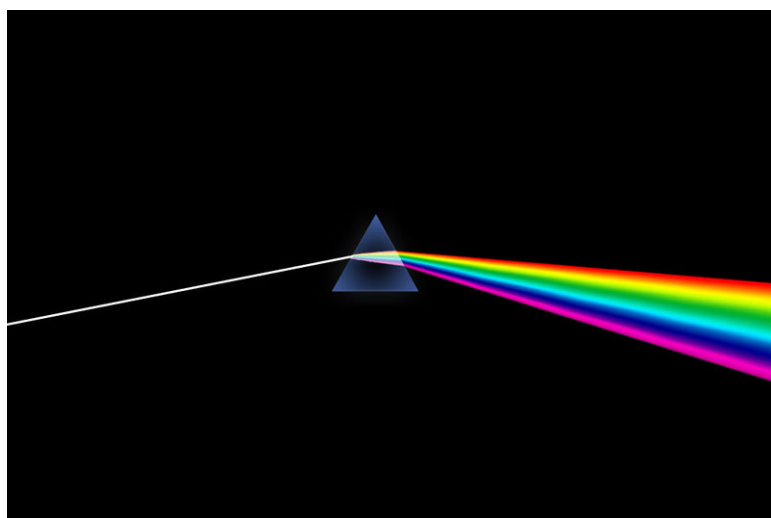

FIGURE 22.5

A prism separates visible light into its different wavelengths.



FIGURE 22.6

The color that objects appear depends on the wavelengths of light they reflect or transmit.

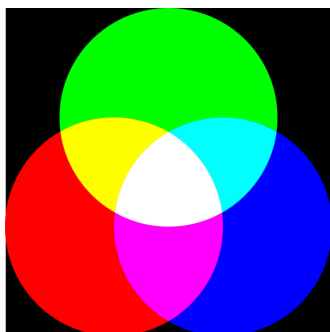
**FIGURE 22.7**

The three primary colors of light—red, green, and blue—combine to form white light in the center of the figure. What are the secondary colors of light? Can you find them in the diagram?

Pigments

Many objects have color because they contain pigments. A **pigment** is a substance that colors materials by reflecting light of certain wavelengths and absorbing light of other wavelengths. A very common pigment is chlorophyll, which is found in plants. This dark green pigment absorbs all but green wavelengths of visible light. It is responsible for “capturing” the light energy needed for photosynthesis. Pigments are also found in paints, inks, and dyes. Just three pigments, called primary pigments, can be combined to produce all other colors. The primary pigment colors are the same as the secondary colors of light: cyan, magenta, and yellow. The printer ink cartridges in **Figure 22.8** come in just these three colors. They are the only colors needed for full-color printing.

**FIGURE 22.8**

Printer ink comes in three primary pigment colors: cyan, magenta, and yellow.

Lesson Summary

- Visible light can be produced by incandescence or luminescence. Incandescence is the production of light by an object that is so hot it glows. Luminescence is the production of light by other means, such as chemical

reactions.

- Light may interact with matter in several ways, including reflection, refraction, transmission, and absorption. Matter can be classified on the basis of how light interacts with it as transparent, translucent, or opaque.
- The wavelength of visible light determines the color that the light appears. Red light has the longest wavelength, and violet light has the shortest wavelength. The primary colors of light are red, green, and blue. All other colors of light can be created by combining the primary colors.

Lesson Review Questions

Recall

1. What is incandescence?
2. Define luminescence.
3. Identify two types of light bulbs and describe how they produce visible light.
4. What determines the color of visible light?
5. List four ways that light interacts with matter.

Apply Concepts

6. If only blue light were to strike the bottle in **Figure 22.6**, what color would the bottle appear?

Think Critically

7. Compare and contrast transparent, translucent, and opaque matter.
8. Explain why snow appears white to the human eye.

Points to Consider

In this lesson, you were introduced to the reflection and refraction of light. The next lesson “Optics” describes how mirrors reflect light and how lenses refract light.

- Based on your own experiences with mirrors, how do you think a mirror forms an image of the person in front of it?
- An example of a lens is a hand lens, also called a magnifying glass. This type of lens makes objects look bigger than they really are. How do you think this happens?

22.2 Optics

Lesson Objectives

- Outline how light is reflected.
- Describe how mirrors reflect light and form images.
- Explain the refraction of light.
- Describe how lenses refract light and form images.
- Explain how mirrors and lenses are used in optical instruments.

Lesson Vocabulary

- concave
- convex
- image
- laser
- law of reflection
- lens
- optics

Introduction

Did you ever see trees or other objects reflected in the still waters of a lake, like the one in **Figure 22.9**? The water in the lake is so calm that it reflects visible light almost as clearly as a mirror. A mirror is one of many devices that people use to extend their ability to see. Mirrors allow people to see themselves as other people see them and also to see behind their back. Mirrors are also used in instruments such as telescopes, which you will read about in this lesson. The use of light in devices such as these is possible because of optics. **Optics** is the study of visible light and the ways it can be used to extend human vision and do other tasks.

Reflection of Light

Almost all surfaces reflect some of the light that strikes them. The still water of the lake in **Figure 22.9** reflects almost all of the light that strikes it. The reflected light forms an image of nearby objects. An **image** is a copy of an object that is formed by reflected or refracted light.



FIGURE 22.9

Still waters of a lake create a mirror image of the surrounding scenery.

Regular and Diffuse Reflection

If a surface is extremely smooth, like very still water, then an image formed by reflection is sharp and clear. This is called regular reflection. If the surface is even slightly rough, an image may not form, or if there is an image, it is blurry or fuzzy. This is called diffuse reflection. Both types of reflection are represented in **Figure 22.10**. You can also see animations of both types of reflection at this URL: <http://toolboxes.flexiblelearning.net.au/demosites/series5/508/laboratory/studynotes/snReflectionMirrors.htm> .

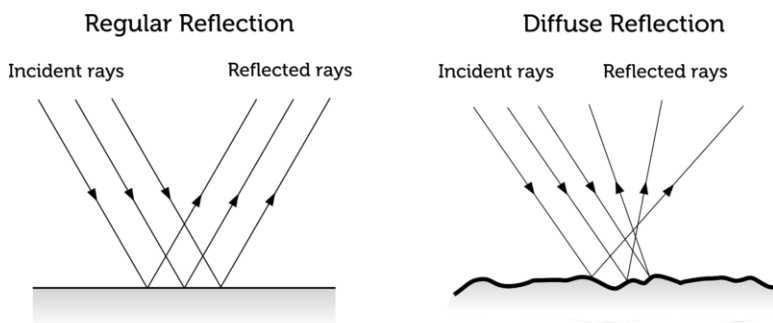

FIGURE 22.10

Whether reflection is regular or diffuse depends on the smoothness of the reflective surface.

In **Figure 22.10**, the waves of light are represented by arrows called rays. Rays that strike the surface are referred to as incident rays, and rays that reflect off the surface are known as reflected rays. In regular reflection, all the rays are reflected in the same direction. This explains why regular reflection forms a clear image. In diffuse reflection, in contrast, the rays are reflected in many different directions. This is why diffuse reflection forms, at best, a blurry image.

Law of Reflection

One thing is true of both regular and diffuse reflection. The angle at which the reflected rays bounce off the surface is equal to the angle at which the incident rays strike the surface. This is the **law of reflection**, and it applies to the

reflection of all light. The law is illustrated in **Figure 22.11** and in the animation at this URL: <http://www.physicsclassroom.com/mmedia/optics/lr.cfm> .

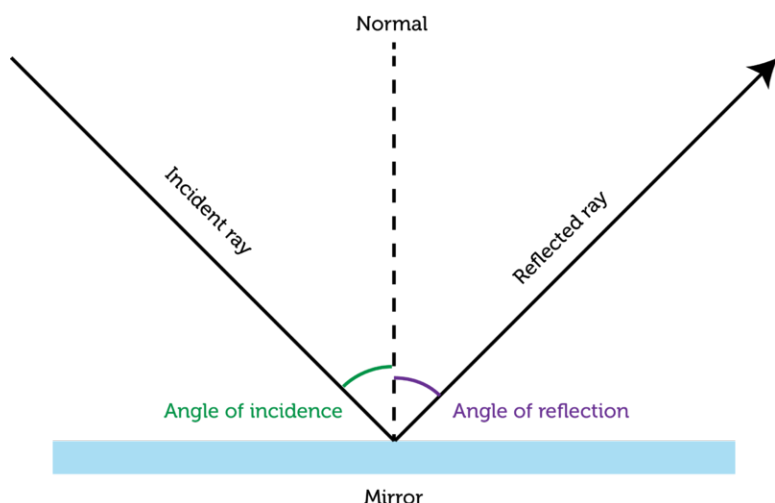
**FIGURE 22.11**

According to the law of reflection, the angle of reflection always equals the angle of incidence. The angles of both reflected and incident light are measured relative to an imaginary line, called normal, that is perpendicular (at right angles) to the reflective surface.

Mirrors

Mirrors are usually made of glass with a shiny metal backing that reflects all the light that strikes it. Mirrors may have flat or curved surfaces. The shape of a mirror's surface determines the type of image the mirror forms. For example, the image may be real or virtual. A real image forms in front of a mirror where reflected light rays actually meet. It is a true image that could be projected on a screen. A virtual image appears to be on the other side of the mirror. Of course, reflected rays don't actually go behind a mirror, so a virtual image doesn't really exist. It just appears to exist to the human eye and brain.

Plane Mirrors

Most mirrors are plane mirrors. A plane mirror has a flat reflective surface and forms only virtual images. The image formed by a plane mirror is also life sized. But something is different about the image compared with the real object in front of the mirror. Left and right are reversed. Look at the man shaving in **Figure 22.12**. He is using his right hand to hold the razor, but his image appears to be holding the razor in the left hand. Almost all plane mirrors reverse left and right in this way.

Concave Mirrors

Some mirrors have a curved rather than flat surface. Curved mirrors can be concave or convex. A **concave** mirror is shaped like the inside of a bowl. This type of mirror forms either real or virtual images, depending on where the object is placed relative to the focal point. The focal point is the point in front of the mirror where the reflected rays intersect. You can see how concave mirrors form images in **Figure 22.13** and in the interactive animation at the URL below. The animation allows you to move an object to see how its position affects the image. Concave mirrors are used behind car headlights. They focus the light and make it brighter. They are also used in some telescopes.

<http://www.splung.com/content/sid/4/page/concavemirrors>



FIGURE 22.12

The term “mirror image” refers to how left and right are reversed in the image compared with the real object.

If the object is farther from the mirror than the focal point is, then the image is real, upside down, and reduced in size.

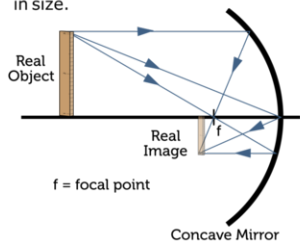

If the object is closer to the mirror than the focal point is, then the image is virtual, right-side up, and enlarged in size.

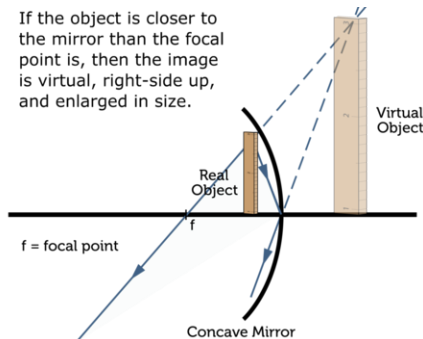

FIGURE 22.13

The image created by a concave mirror depends on how far the object is from the mirror.

Convex Mirrors

The other type of curved mirror, a **convex** mirror, is shaped like the outside of a bowl. This type of mirror forms only virtual images. The image is always right-side up and smaller than the actual object, which makes the object appear farther away than it really is. You can see how a convex mirror forms an image in **Figure 22.14** and in the animation at the URL below. Because of their shape, convex mirrors can gather and reflect light from a wide area. This is why they are used as side mirrors on cars. They give the driver a wider view of the area around the vehicle than a plane mirror would.

<http://physics.slss.ie/resources/convex%20mirror.swf>

Refraction of Light

Although the speed of light is constant in a vacuum, light travels at different speeds in different kinds of matter. For example, light travels more slowly in glass than in air. Therefore, when light passes from air to glass, it slows down. If light strikes a sheet of glass straight on, or perpendicular to the glass, it slows down but passes straight through. However, if light enters the glass at an angle other than 90° , the wave refracts, or bends. This is illustrated in **Figure 22.15**. How much light bends when it enters a new medium depends on how much it changes speed. The greater the change in speed, the more light bends.

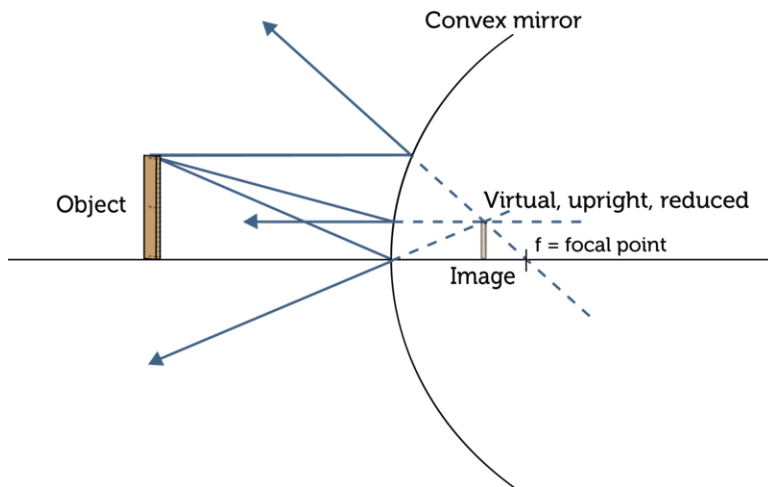

FIGURE 22.14

A convex mirror forms a virtual image that appears to be on the opposite side of the mirror from the object. How is the image different from the object?

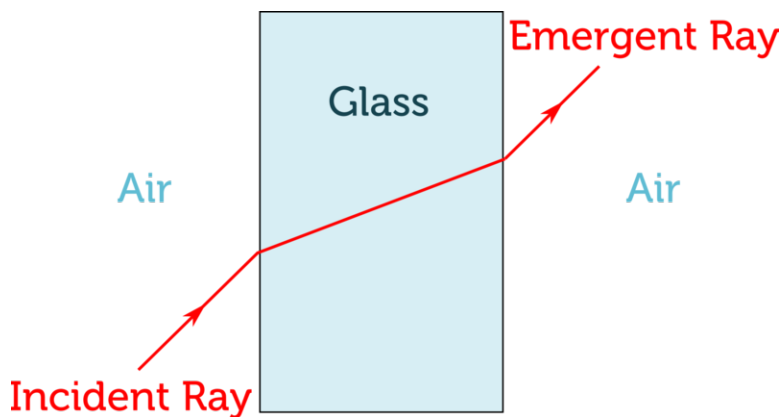

FIGURE 22.15

Light refracts when it passes from one medium to another at an angle other than 90° . Can you explain why?

Lenses

Lenses make use of the refraction of light to create images. A **lens** is a transparent object, typically made of glass, with one or two curved surfaces. The more curved the surface of a lens is, the more it refracts light. Like mirrors, lenses may be concave or convex.

Concave Lenses

Concave lenses are thicker at the edges than in the middle. They cause rays of light to diverge, or spread apart. **Figure 22.16** shows how a concave lens forms an image. The image is always virtual and on the same side of the lens as the object. The image is also right-side up and smaller than the object. Concave lenses are used in cameras. They focus reduced images inside the camera, where they are captured and stored. You can explore the formation of images by a concave lens with the interactive animation at this URL: http://phet.colorado.edu/sims/geometric-optics/geometric-optics_en.html .

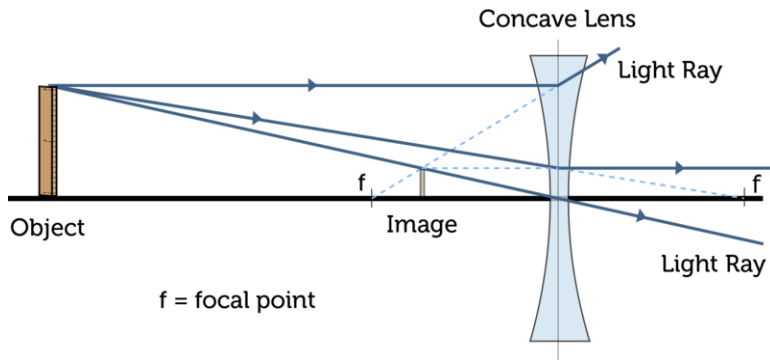

FIGURE 22.16

The image formed by a concave lens is a virtual image.

Convex Lenses

Convex lenses are thicker in the middle than at the edges. They cause rays of light to converge, or meet, at a point called the focus (F). Convex lenses form either real or virtual images. It depends on how close an object is to the lens relative to the focus. **Figure 22.17** shows how a convex lens works. You can also interact with an animated convex lens at the URL below. An example of a convex lens is a hand lens.

<http://www.phy.ntnu.edu.tw/ntnujava/index.php?topic=1395.msg5241#msg5241>

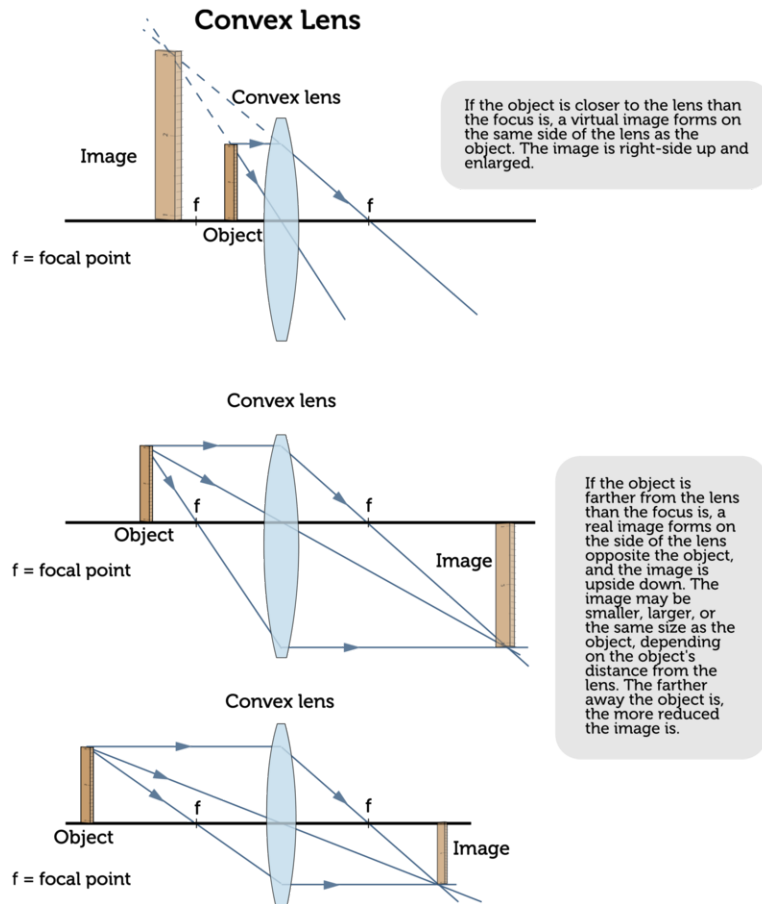

FIGURE 22.17

The type of image made by a convex lens depends on how close the object is to the lens. Which diagram shows how a hand lens makes an image?

Optical Instruments

Mirrors and lenses are used in optical instruments to reflect and refract light. Optical instruments include microscopes, telescopes, cameras, and lasers.

Light Microscopes

A light microscope is an instrument that uses lenses to make enlarged images of objects that are too small for the unaided eye to see. A common type of light microscope is a compound microscope, like the one in **Figure 22.18**. A compound microscope has at least two convex lenses: one or more objective lenses and one or more eyepiece lenses. The objective lenses are close to the object being viewed. They form an enlarged image of the object inside the microscope. The eyepiece lenses are close to the viewer's eyes. They form an enlarged image of the first image. The magnifications of all the lenses are multiplied together to yield the overall magnification of the microscope. Some light microscopes can magnify objects more than 1000 times! For more on light microscopes and the images they create, watch the video at this URL: <http://www.youtube.com/watch?v=Xo7mr90GYLA> (7:29).



MEDIA

Click image to the left for more content.

Telescopes

Like microscopes, telescopes use convex lenses to make enlarged images. However, telescopes make enlarged images of objects—such as distant stars—that only appear tiny because they are very far away. There are two basic types of telescopes: reflecting telescopes and refracting telescopes. The two types are compared in **Figure 22.19**. You can learn more about telescopes and how they evolved in the video at this URL: <http://www.videojug.com/film/how-does-a-telescope-work> .

Cameras

A camera is an optical instrument that records an image of an object. The image may be recorded on film or it may be detected by an electronic sensor that stores the image digitally. Regardless of how the image is recorded, all cameras form images in the same basic way, as demonstrated in **Figure 22.20** and at the URL below. Light passes through the lens at the front of the camera and enters the camera through an opening called the aperture. As light passes through the lens, it forms a reduced real image. The image focuses on film (or a sensor) at the back of the camera. The lens may be moved back and forth to bring the image into focus. The shutter controls the amount of light that strikes the film (or sensor). It stays open longer in dim light to let more light in. For a series of animations showing how a camera works, go to this URL: <http://www.shortcourses.com/guide/guide1-3.html> .

Lasers

Did you ever see a cat chase after a laser light, like the one in **Figure 22.21**? A **laser** is a device that produces a very focused beam of light of just one wavelength and color. Waves of laser light are synchronized so the crests and troughs of the waves line up (see **Figure 22.21**).

How a Compound Microscope Works

The object to be viewed is placed on a glass platform called the stage.

Bright light reflects off a small plane mirror, and shines upward through the stage and the objective lenses above it.

The viewer looks through eyepiece lenses to see the magnified image of the object.

Knobs on the side of the microscope allow the viewer to move the lenses up or down in order to bring the image into focus.

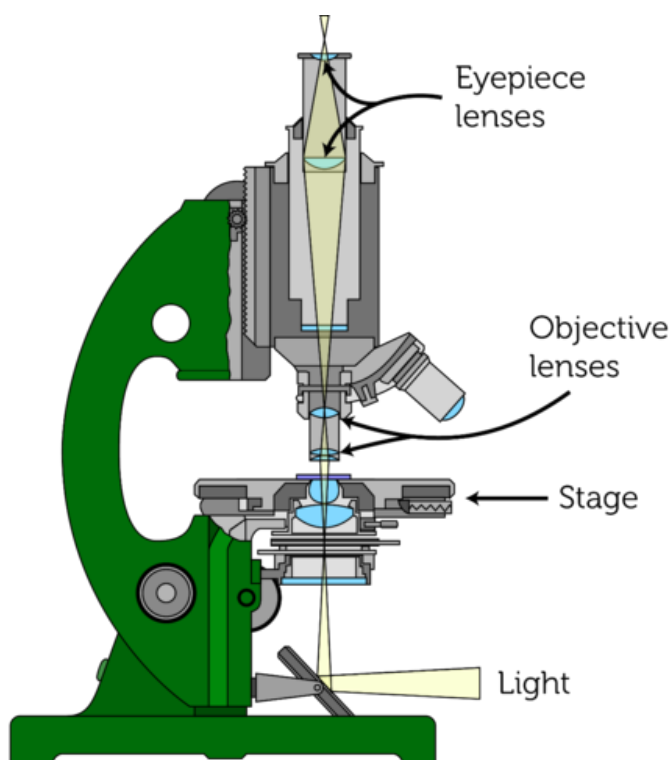
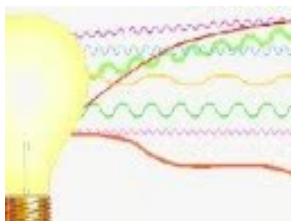

FIGURE 22.18

A compound microscope uses convex lenses to make enlarged images of tiny objects.

Laser light is created in a tube like the one shown in **Figure 22.22**. Electrons in a material such as a ruby crystal are stimulated to radiate photons of light of one wavelength. At each end of the tube is a concave mirror. The photons of light bounce back and forth in the tube off the mirrors. This focuses the light. The mirror at one end of the tube is partly transparent. A constant stream of photons passes through the transparent part, forming the laser beam. You can see an animation showing how a laser works at this URL: <http://www.youtube.com/watch?v=gUbBzEXIEho> (1:12).



MEDIA

Click image to the left for more content.

Besides entertaining a cat, laser light has many other uses. It is used to scan bar codes, for example, and to carry communication signals in optical fibers. Optical fibers are extremely thin glass tubes that are used to guide laser light (see **Figure 22.23**). Sounds or pictures are encoded in pulses of laser light, which are then sent through an optical fiber. All of the light reflects off the inside of the fiber, so none of it escapes. As a result, the signal remains strong even over long distances. More than one signal can travel through an optic fiber at the same time, as you can see in **Figure 22.23**. Optical fibers are used to carry telephone, cable TV, and Internet signals.

Reflecting Telescope

A reflecting telescope uses a concave mirror to collect and focus light. The light then strikes a smaller plane mirror, which reflects the light into the eyepiece at the side of the telescope. (The eyepiece is on the side so it doesn't block incoming light.) A convex lens in the eyepiece enlarges the image.

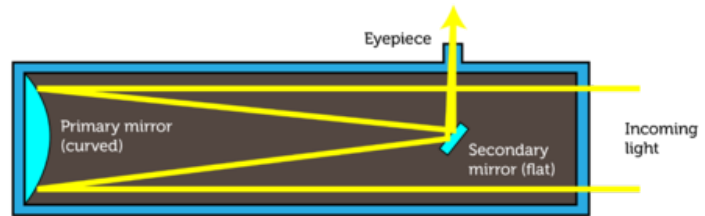

Refracting Telescope

A refracting telescope uses a convex lens to collect and focus light. It uses another convex lens in the eyepiece to enlarge the image made by the first convex lens.

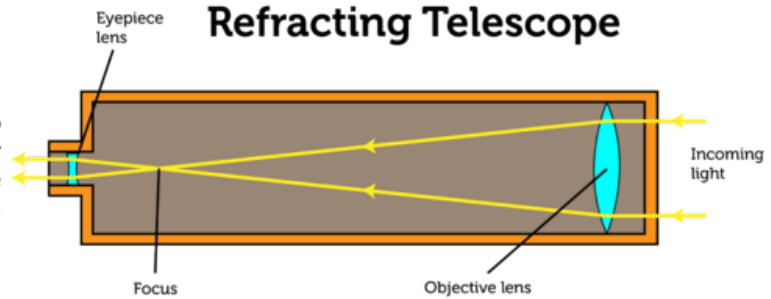

FIGURE 22.19

These telescopes differ in how they collect light, but both use convex lenses to enlarge the image.

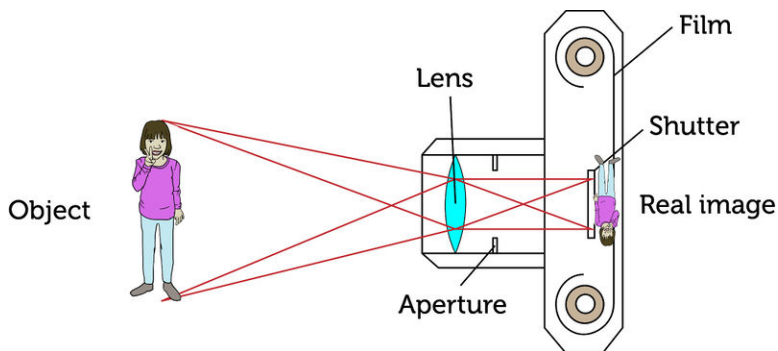
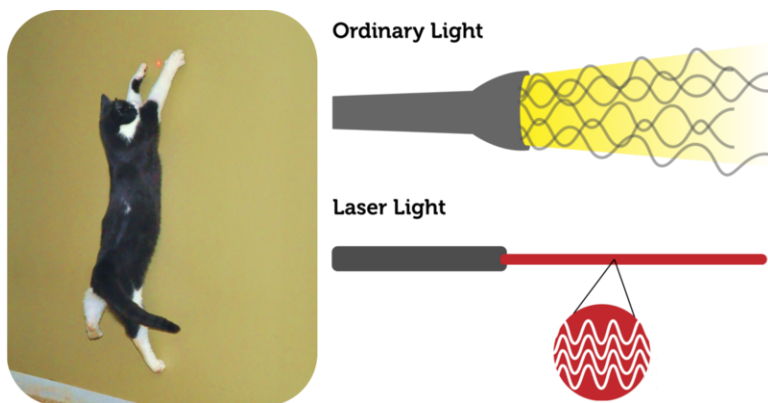

FIGURE 22.20

A camera uses a convex lens to form an image on film or a sensor.

Lesson Summary

- Objects that reflect or refract light may form images. An image is a copy of an object that is formed by reflected or refracted light. According to the law of reflection, light is reflected at the same angle that it strikes a reflective surface.
- Mirrors reflect all of the light that strikes them and form images. A plane, or flat, mirror forms virtual, life-sized images. A concave mirror forms either enlarged virtual images or reduced real images. A convex mirror forms only reduced virtual images.
- Refraction, or bending, of light occurs when light passes from one medium to another at an angle other than

**FIGURE 22.21**

A very focused beam of bright laser light moves around the room for the cat to chase. The diagram shows why the beam of laser light is so focused compared with ordinary light from a flashlight.

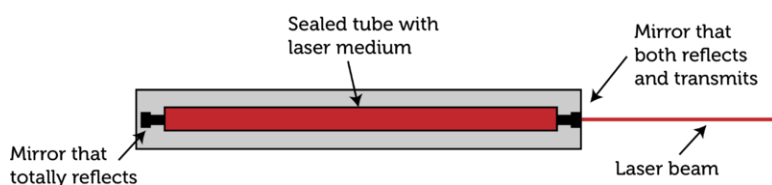
**FIGURE 22.22**

A laser light uses two concave mirrors to focus photons of colored light.

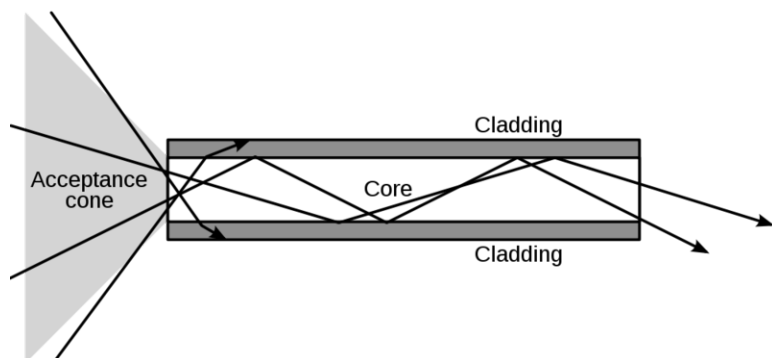
**FIGURE 22.23**

An optical fiber carries pulses of laser light. The outer cladding and inner core refract light by different amounts, so that all of the light is reflected back into the core. The optical fiber in the diagram is much larger than a real optical fiber, which is only about as wide as a human hair.

90° and the speed of light changes in the new medium. The greater the change in speed, the more light bends.

- Lenses are transparent objects with curved surfaces that refract light and form images. Concave lenses form only reduced virtual images. Convex lenses form either enlarged virtual images or real images that may be enlarged or reduced.
- Mirrors and lenses are used in optical instruments to reflect or refract light. Optical instruments include microscopes, telescopes, cameras, and lasers.

Lesson Review Questions

Recall

1. Define optics.

2. State the law of reflection.
3. What type of images does a convex mirror form?
4. What type of images does a concave lens form?
5. Choose an optical instrument described in this lesson and state how it uses lenses and/or mirrors to focus visible light.

Apply Concepts

6. Assume that a light shines upward through the water of a swimming pool. Create a diagram to show what happens to the light when it passes from the water to the air above the water's surface. The light should enter the air at an angle other than 90° . Explain your diagram to another student.

Think Critically

7. Compare and contrast regular and diffuse reflection.
8. Explain how concave mirrors form real and virtual images.
9. Relate focus and position of an object to the image formed by a convex lens.

Points to Consider

In this lesson, you read how convex and concave lenses refract light. The human eye, which you can read about in the next lesson "Vision," also contains a lens.

- How do you think the lens in the eye works? What is its role in vision?
- Do you think the lens in the eye is a concave lens or a convex lens?

22.3 Vision

Lesson Objectives

- Describe the structure and function of the eye.
- Explain how the eyes and brain work together to enable vision.
- Identify common vision problems and how they can be corrected.

Introduction

A certain optical instrument uses a convex lens to focus an image on a surface, where the image is encoded in electrical signals. The signals are then transmitted to an extremely fast and complex computer, which interprets the signals as an image. Can you guess what the optical instrument is? The “instrument” is the human eye. And the “computer”? It’s the human brain. In this lesson, you’ll learn how the eyes and brain work together to enable human vision.

Structure and Function of the Eye

The structure of the human eye is shown in **Figure 22.24**. Find each structure in the diagram as you read about it below.

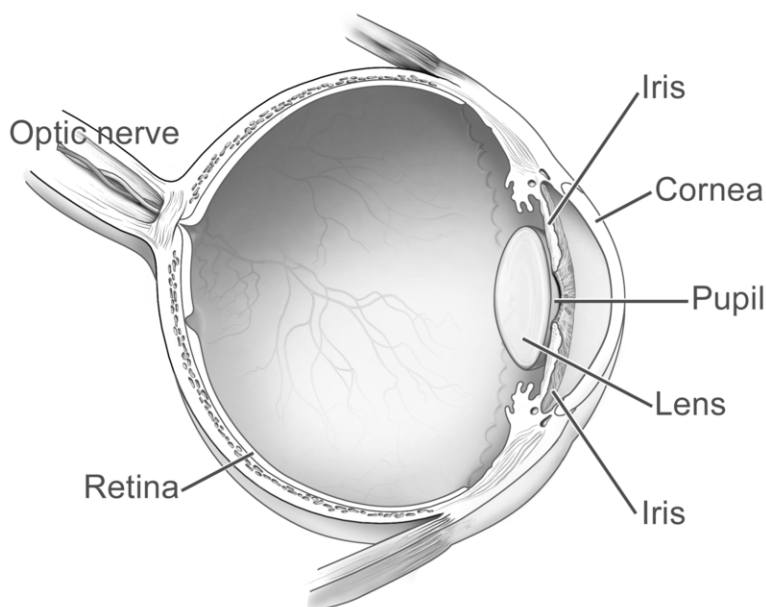

FIGURE 22.24

The human eye is the organ specialized to collect light and focus images.

Structures of the Eye

- The cornea is the transparent outer covering of the eye. It protects the eye and also acts as a convex lens, helping to focus light that enters the eye.
- The pupil is an opening in the front of the eye. It looks black because it doesn't reflect any light. It allows light to enter the eye. The pupil automatically gets bigger or smaller to let more or less light in as needed.
- The iris is the colored part of the eye. It controls the size of the pupil.
- The lens is a convex lens that fine-tunes the focus so an image forms on the back of the eye. Tiny muscles control the shape of the lens to focus images of close or distant objects.
- The retina is a membrane lining the back of the eye. The retina has nerve cells called rods and cones that change images to electrical signals. Rods are good at sensing dim light but can't distinguish different colors of light. Cones can sense colors but not in dim light. There are three different types of cones. Each type senses one of the three primary colors of light.
- The optic nerve carries electrical signals from the rods and cones to the brain.

How We See

As just described, the eyes collect and focus visible light. The lens and other structures of the eye work together to focus a real image on the retina. The image is upside-down and reduced in size, as you can see in **Figure 22.25**. The image reaches the brain as electrical signals that travel through the optic nerve. The brain interprets the signals as shape, color, and brightness. It also interprets the image as though it were right-side up. The brain does this automatically, so what we see is always right-side up. The brain also “tells” us what we are seeing.

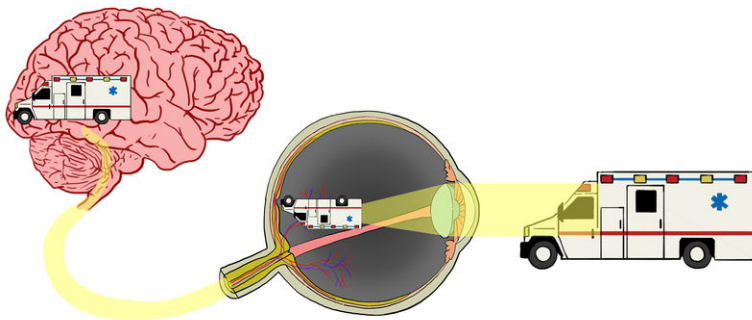

FIGURE 22.25

The brain and eyes work together to allow us to see.

Vision Problems

Many people have vision problems. The problems often can be corrected with contact lenses or lenses in eyeglasses. Some vision problems can also be corrected with laser surgery, which reshapes the cornea. Two of the most common vision problems are nearsightedness and farsightedness. You may even have one of these conditions yourself. Both

are illustrated in **Figure 22.26** and in the video at this URL: <http://www.youtube.com/watch?v=ekSGbXt4XdI> (1:08).



MEDIA

Click image to the left for more content.

- Nearsightedness, or myopia, is the condition in which nearby objects are seen clearly, but distant objects are blurry. It occurs when the eyeball is longer than normal. This causes images to be focused in front of the retina. Myopia can be corrected with concave lenses. The lenses focus images farther back in the eye, so they are on the retina instead of in front of it.
- Farsightedness, or hyperopia, is the condition in which distant objects are seen clearly, but nearby objects are blurry. It occurs when the eyeball is shorter than normal. This causes images to be focused in back of the retina. Hyperopia can be corrected with convex lenses. The lenses focus images farther forward in the eye, so they are on the retina instead of behind it.

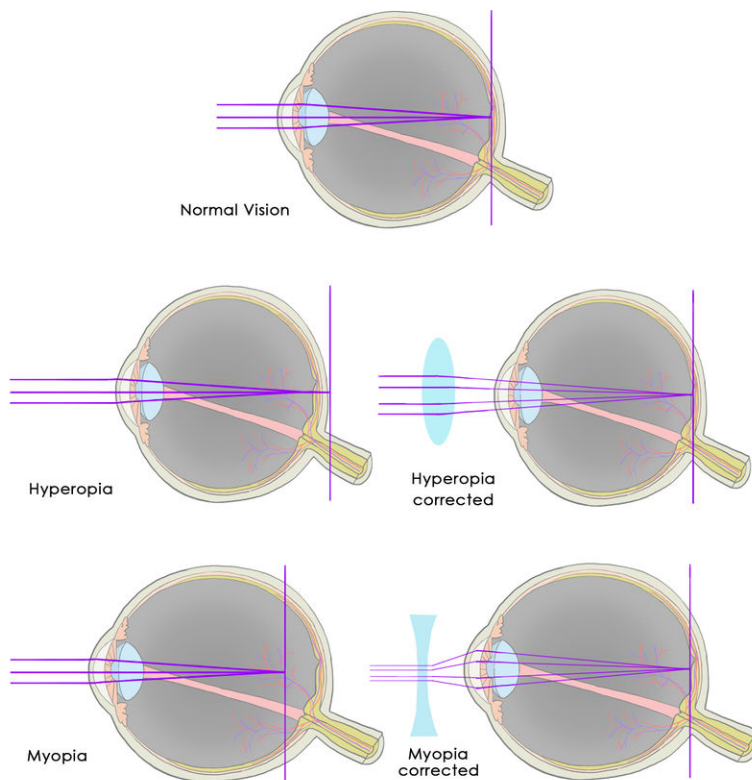

FIGURE 22.26

Myopia and hyperopia can be corrected with lenses.

Lesson Summary

- The structures of the human eye collect and focus light. They form a reduced, upside-down image on the retina at the back of the eye.
- The image focused by the eye travels through the optic nerve to the brain as electrical signals. The brain interprets the signals and “tells” us what we are seeing.
- Common vision problems include nearsightedness (myopia), which can be corrected with concave lenses, and farsightedness (hyperopia), which can be corrected with convex lenses.

Lesson Review Questions

Recall

1. How are the pupil and iris related?
2. Which parts of the eye focus light?
3. Describe the retina.
4. What is the function of the optic nerve?
5. In an eye with normal vision, where are images focused?

Apply Concepts

6. Create a lesson for younger students to teach them how the eye works. With your teacher’s approval, present your lesson to a class in a lower grade.

Think Critically

7. Compare and contrast rods and cones.
8. Why is the brain needed for vision?
9. Identify a common vision problem and explain how lenses can be used to correct it.

Points to Consider

This chapter focuses on energy in the form of visible light. Another common form of energy, electrical energy, is the focus of the chapter *Electricity*.

- What are some ways you use electrical energy?
- Where does the electrical energy you use come from?

For **Table 22.1**:

- Incandescent bulb: Olga Reznik. <http://www.flickr.com/photos/belobaba/6058142799/> . CC BY 2.0.
- Fluorescent bulb: Vasenka Photography. <http://www.flickr.com/photos/vasenka/6635890033/> . CC BY 2.0.
- Neon light: Brian Kelly. <http://www.flickr.com/photos/y2bk/528300692/> . CC BY 2.0.
- Vapor light: Robert Ashworth. <http://www.flickr.com/photos/theslowlane/7967029974/> . CC BY 2.0.

- LED traffic light: User:Bidgee/Wikimedia Commons. http://commons.wikimedia.org/wiki/File:LED_traffic_light.jpg . CC BY 3.0.

22.4 References

1. Wen Shi (Flickr:Vincent in Motion). <http://www.flickr.com/photos/s82911/9150958552/> . CC BY 2.0
2. Jellyfish: Florida Keys National Marine Sanctuary Staff/Florida Keys National Marine Sanctuary, courtesy of the National Oceanic and Atmospheric Administration; Firefly: Mike Lewinski. Jellyfish: <http://www.photolib.noaa.gov/htmls/reef2547.htm>; Firefly: <http://www.flickr.com/photos/ikewinski/8234761775/> . Jellyfish: Public Domain; Firefly: CC BY 2.0
3. Revolving door: Elliott Brown (Flickr:ell brown); Frosted glass door: Oleg Sidorenko (Flickr:oksidor); Wooden door: Robyn Gallant (Flickr:rgallant_photography); Glass mirror: Neeta Lind. Revolving door: <http://www.flickr.com/photos/ell-r-brown/8723266545/>; Frosted glass door: <http://www.flickr.com/photos/ksidor/547535833/>; Wooden door: <http://www.flickr.com/photos/rgallant/4198121751/>; Glass mirror: http://www.flickr.com/photos/neeta_lind/8605699780/ . CC BY 2.0
4. Christopher Auyeung. [CK-12 Foundation](#) . CC BY-NC 3.0
5. Ivan T. <http://www.flickr.com/photos/iwannt/6931116587/> . CC BY 2.0
6. Red apple: Flickr:Origami48616; Blue bottle: Scott Robinson (Flickr:Clearly Ambiguous). Red apple: <http://www.flickr.com/photos/origami48616/8653658582/>; Blue bottle: <http://www.flickr.com/photos/clearlyambiguous/83377578/> . CC BY 2.0
7. User:DarkEvil/Wikimedia Commons. http://commons.wikimedia.org/wiki/File:Additive_color.svg . Public Domain
8. Flickr:unicron1bot. <http://www.flickr.com/photos/unicronbot/8910401063/> . CC BY 2.0
9. Flickr:p-a-t-r-i-c-k. <http://www.flickr.com/photos/patrickkiteley/2634310565/> . CC BY 2.0
10. Joy Sheng. [CK-12 Foundation](#) . CC BY-NC 3.0
11. Christopher Auyeung. [CK-12 Foundation](#) . CC BY-NC 3.0
12. Flickr:maol. <http://www.flickr.com/photos/maol/1904926915/> . CC BY 2.0
13. Christopher Auyeung. [CK-12 Foundation](#) . CC BY-NC 3.0
14. Christopher Auyeung. [CK-12 Foundation](#) . CC BY-NC 3.0
15. Joy Sheng. [CK-12 Foundation](#) . CC BY-NC 3.0
16. Christopher Auyeung. [CK-12 Foundation](#) . CC BY-NC 3.0
17. Christopher Auyeung. [CK-12 Foundation](#) . CC BY-NC 3.0
18. User:Tomia/Wikimedia Commons, modified by Christopher Auyeung (CK-12 Foundation). <http://commons.wikimedia.org/wiki/File:Microscope-blank.svg> . CC BY 2.5
19. Christopher Auyeung. [CK-12 Foundation](#) . CC BY-NC 3.0
20. Laura Guerin. [CK-12 Foundation](#) . CC BY-NC 3.0
21. Left: Flickr:jeffreyw; Right: Christopher Auyeung. Left: <http://www.flickr.com/photos/7927684@N03/4326557024/>; Right: [CK-12 Foundation](#) . Left: CC-BY 2.0; Right: CC BY-NC 3.0
22. Christopher Auyeung. [CK-12 Foundation](#) . CC BY-NC 3.0
23. User:Gringer/Wikimedia Commons. <http://commons.wikimedia.org/wiki/File:Optical-fibre.svg> . Public Domain
24. Courtesy of National Eye Institute, National Institutes of Health. http://www.nei.nih.gov/photo/search/ref_num.asp?ref=NEA08 . Public Domain
25. Laura Guerin. [CK-12 Foundation](#) . CC BY-NC 3.0
26. Laura Guerin. [CK-12 Foundation](#) . CC BY-NC 3.0

CHAPTER 23

Electricity

Chapter Outline

- 23.1 ELECTRIC CHARGE**
- 23.2 ELECTRIC CURRENT**
- 23.3 ELECTRIC CIRCUITS**
- 23.4 ELECTRONICS**
- 23.5 REFERENCES**



The giant electric pylon in this photo looks a little bit like a space alien marching across the land. The pylon supports heavy electric cables that carry electricity from the transfer station in the background to a distant city. The electricity that flows through wires in your home probably travels through cables on pylons like this one. Did you notice the other source of electricity in the photo? The brilliant bolt of lightning is a huge discharge of electricity from the clouds to the ground. Where do these two sources of electricity come from? In this chapter, you'll find out.

Image copyright Josemaria Toscano, 2013. www.shutterstock.com. Used under license from Shutterstock.com.

23.1 Electric Charge

Lesson Objectives

- Define electric charge and electric force.
- Describe electric fields.
- Identify ways that electric charge is transferred.

Lesson Vocabulary

- electric charge
- electric field
- electric force
- law of conservation of charge
- static discharge
- static electricity

Introduction

Has this ever happened to you? You walk across a carpet, reach out to touch a metal doorknob, and get an unpleasant electric shock (see **Figure 23.1**). The reason you get a shock is because of moving electric charges. Moving electric charges also create lightning bolts and the electric current that flows through cables and wires.

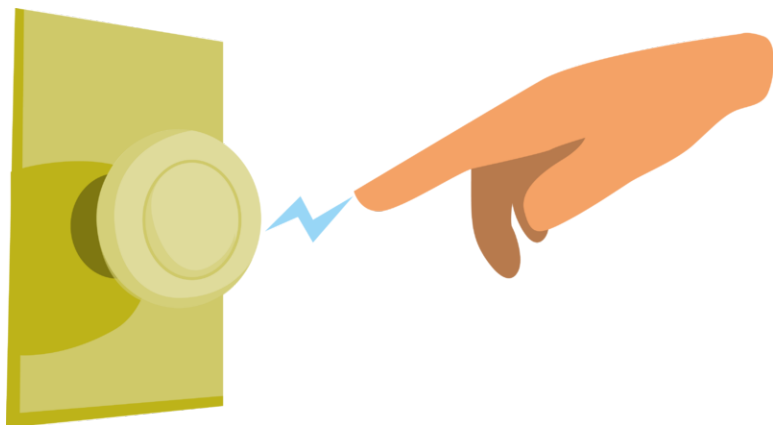

FIGURE 23.1

Moving electric charges explain why you get a shock when you touch a doorknob after walking across a carpet.

Electric Charge and Electric Force

Electric charge is a physical property of particles or objects that causes them to attract or repel each other without touching. All electric charge is based on the protons and electrons in atoms. A proton has a positive electric charge, and an electron has a negative electric charge (see **Figure 23.2**).

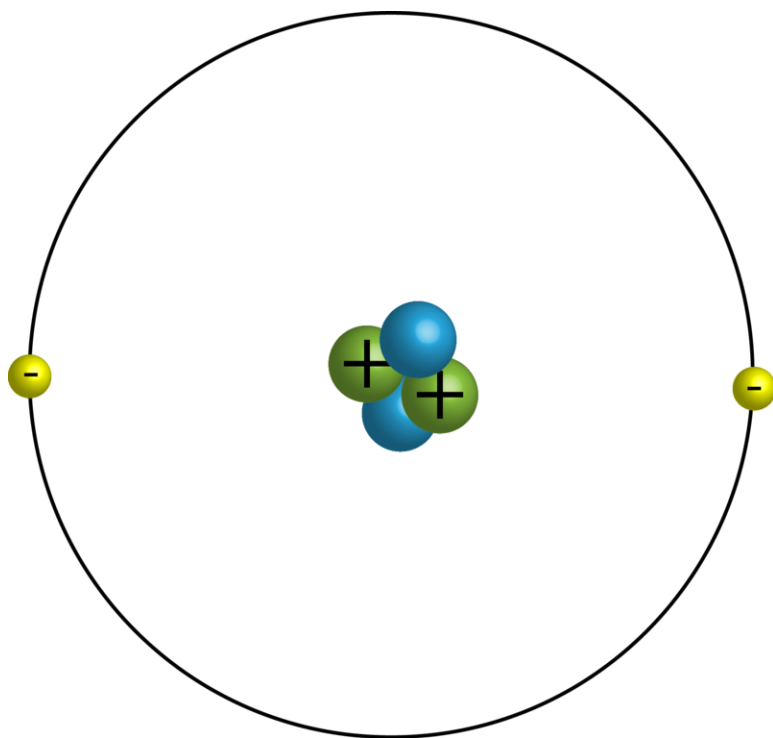

FIGURE 23.2

Positively charged protons (+) are located in the nucleus of an atom. Negatively charged electrons (-) move around the nucleus.

When it comes to electric charges, opposites attract. In other words, positive and negative particles are attracted to each other. Like charges, on the other hand, repel each other, so two positive or two negative charges push apart from each other. The force of attraction or repulsion between charged particles is called **electric force**. It is illustrated in **Figure 23.3**. The strength of electric force depends on the amount of electric charge and the distance between the charged particles. The larger the charge or the closer together the charges are, the greater is the electric force.

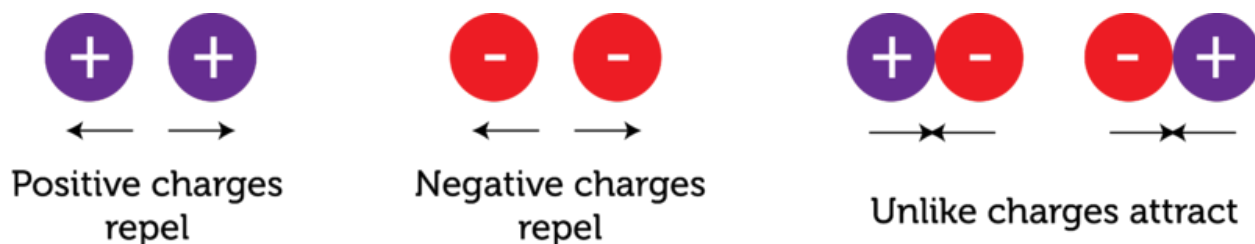

FIGURE 23.3

These diagrams illustrate the electric forces between charged particles.

Electric Fields

Electric force is exerted over a distance, so charged particles do not have to be in contact in order to exert force over each other. That's because each charged particle is surrounded by an electric field. An **electric field** is a space around a charged particle where the particle exerts electric force on other particles. Electric fields surrounding positively and negatively charged particles are illustrated in **Figure 23.4** and at the URL below. When charged particles exert force on each other, their electric fields interact. This is also illustrated in **Figure 23.4**.

<http://www.learnerstv.com/animation/animation.php?ani=86&cat=physics>

Electric Fields of Individual Charged Particles (Point Charges):

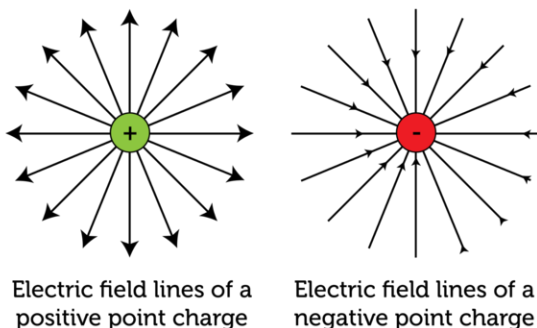
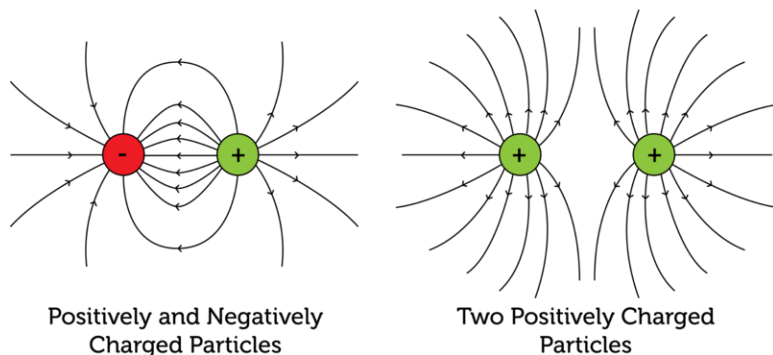

FIGURE 23.4

Field lines represent lines of force in the electric field around a charged particle. The lines bend when two particles interact. What would the lines of force look like around two negatively charged particles?

Interacting Electric Fields of Two Charged Particles:



Transfer of Electric Charges

Atoms are neutral in electric charge because they have the same number of electrons as protons. However, atoms may transfer electrons and become charged ions, as illustrated in **Figure 23.5**. Positively charged ions, or cations, form when atoms give up electrons. Negatively charged ions, or anions, form when atoms gain electrons.

Like the formation of ions, the formation of charged matter in general depends on the transfer of electrons either between two materials or within a material. Three ways this can occur are friction, conduction, and polarization. In all cases, the total charge remains the same. Electrons move, but they aren't destroyed. This is the **law of conservation of charge**.

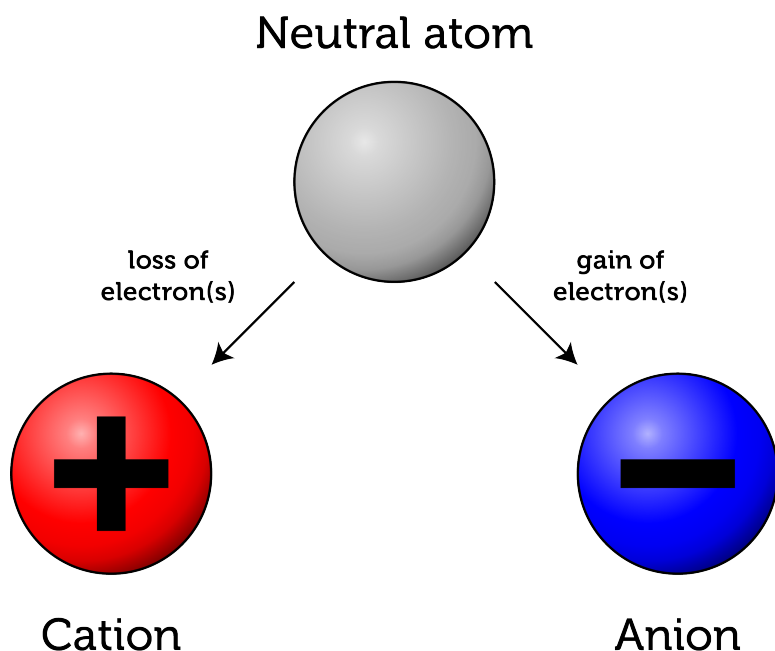
**FIGURE 23.5**

Atoms are electrically neutral, but if they lose or gain electrons they become charged particles called ions.

Friction

Did you ever rub an inflated balloon against your hair? You can see what happens in **Figure 23.6**. Friction between the rubber of the balloon and the baby's hair results in electrons from the hair "rubbing off" onto the balloon. That's because rubber attracts electrons more strongly than hair does. After the transfer of electrons, the balloon becomes negatively charged and the hair becomes positively charged. As a result, the individual hairs repel each other and the balloon and the hair attract each other. Electrons are transferred in this way whenever there is friction between materials that differ in their ability to give up or accept electrons.

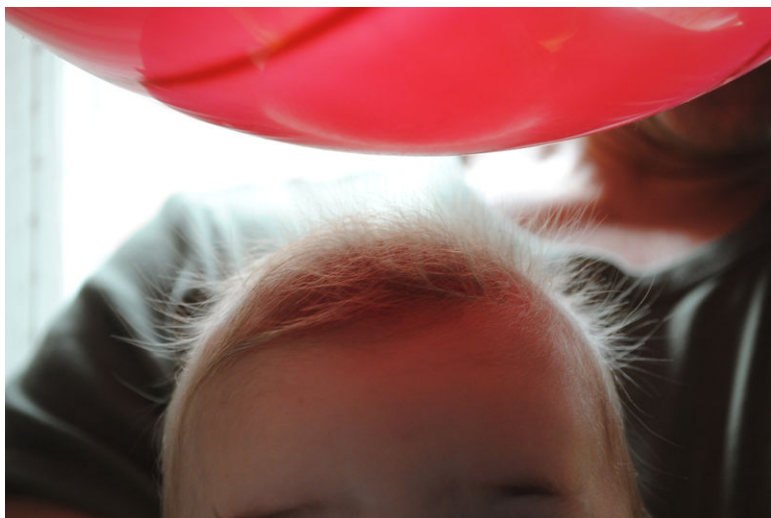
**FIGURE 23.6**

Electrons are transferred from hair to a balloon rubbed against the hair. Then the oppositely charged hair and balloon attract each other.

Conduction

Another way electrons may be transferred is through conduction. This occurs when there is direct contact between materials that differ in their ability to give up or accept electrons. For example, wool tends to give up electrons and rubber tends to accept them. Therefore, when you walk across a wool carpet in rubber-soled shoes, electrons transfer from the carpet to your shoes. You become negatively charged, while the carpet becomes positively charged.

Another example of conduction is pictured in **Figure 23.7**. The device this girl is touching is called a van de Graaff generator. The dome on top is negatively charged. When the girl places her hand on the dome, electrons are transferred to her, so she becomes negatively charged as well. Even the hairs on her head become negatively charged. As a result, individual hairs repel each other, causing them to stand on end. You can see a video demonstration of a van de Graff generator at this URL: <http://www.youtube.com/watch?v=SREXQWAIDJk> .



FIGURE 23.7

Electrons flow to the girl from the dome. She becomes negatively charged right down to the tips of her hair.

Polarization

Polarization is the movement of electrons within a neutral object due to the electric field of a nearby charged object. It occurs without direct contact between the two objects. You can see how it happens in **Figure 23.8**. When the negatively charged plastic rod in the figure is placed close to the neutral metal plate, electrons in the plate are repelled by the positive charges in the rod. The electrons move away from the rod, causing one side of the plate to become positively charged and the other side to become negatively charged.

Polarization may also occur after you walk across a wool carpet in rubber-soled shoes and become negatively charged. If you reach out to touch a metal doorknob, electrons in the neutral metal will be repelled and move away from your hand before you even touch the knob. In this way, one end of the doorknob becomes positively charged and the other end becomes negatively charged.

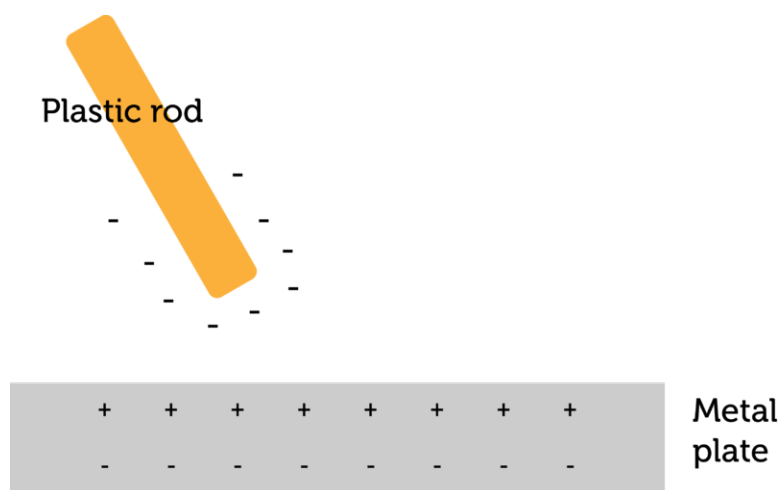

FIGURE 23.8

Polarization occurs between a charged and neutral object.

Static Electricity and Static Discharge

Polarization leads to the buildup of electric charges on objects. This buildup of charges is known as **static electricity**. Once an object becomes charged, it is likely to remain charged until another object touches it or at least comes very close to it. That's because electric charge cannot travel easily through air, especially if the air is dry.

Consider again the example of your hand and the metal doorknob. When your negatively charged hand gets very close to the positively charged doorknob, the air between your hand and the knob may become electrically charged. If that happens, it allows electrons to suddenly flow from your hand to the knob. This is the electric shock you feel when you reach for the knob. You may even see a spark as the electrons jump from your hand to the metal. This sudden flow of electrons is called **static discharge**. Another example of static discharge, on a much larger scale, is lightning. You can see how it occurs in **Figure 23.9**. At the URL below, you can watch a slow-motion lightning strike. Be sure to wait for the real-time lightning strike at the very end of the video.

<http://www.youtube.com/watch?v=Y8oN0YFAXWQ>

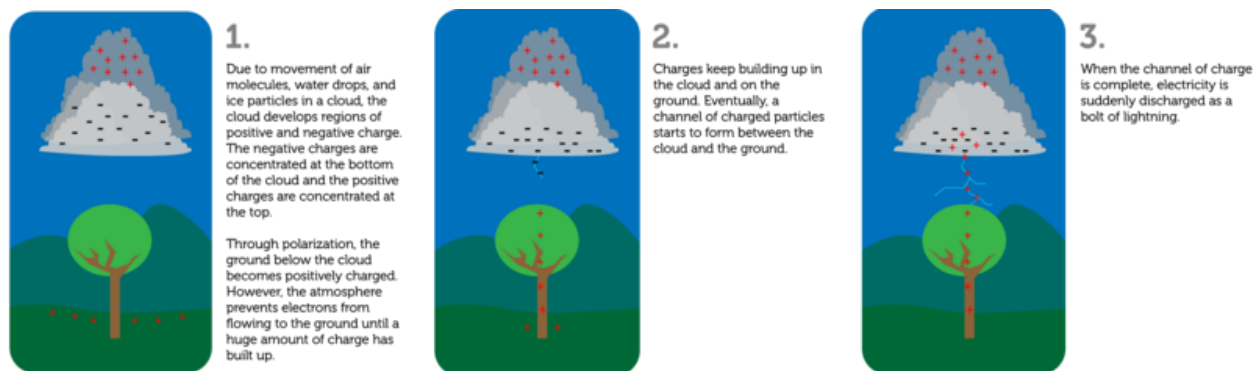

FIGURE 23.9

Lightning occurs when there is a sudden discharge of static electricity between a cloud and the ground.

Lesson Summary

- Electric charge is a physical property of particles or objects that causes them to attract or repel each other without touching. Positive and negative particles attract each other. Particles with the same charge repel each other. The force of attraction or repulsion between charged particles is called electric force.
- A charged particle can attract or repel other, nearby particles without touching them because it is surrounded by an electric field. This is a space around the particle where it exerts electric force on other particles.
- Objects become charged when they transfer electrons. This can happen through friction, conduction, or polarization. Although electrons are transferred, the total charge remains the same. Polarization may cause a buildup of charges on an object known as static electricity. Static discharge occurs when the built-up charges suddenly flow from the object. An example of static discharge is lightning.

Lesson Review Questions

Recall

1. Define electric charge.
2. Describe the forces between charged particles.
3. What is an electric field?
4. State the law of conservation of charge.
5. Outline how lightning occurs.

Apply Concepts

6. If you rub a piece of tissue paper on a plastic comb, the paper and comb stick together. Based on lesson concepts, explain why this happens.

Think Critically

7. Compare and contrast the ways that friction, conduction, and polarization transfer electric charge.

Points to Consider

You read in this lesson that lightning is a flow of electric charges. The electric current that flows through wires in your home is also a flow of electric charges. You'll read about electric current in the next lesson, "Electric Current."

- How might the electric current in a wire inside the walls of a house differ from a bolt of lightning?
- Lightning strikes may injure people or start fires. How do you think current can be used safely inside the walls of buildings?

23.2 Electric Current

Lesson Objectives

- Define electric current.
- Explain how voltage is related to electric current.
- Identify sources of voltage
- Relate electric current to materials.
- State Ohm's law.

Lesson Vocabulary

- alternating current (AC)
- direct current (DC)
- electric conductor
- electric current
- electric insulator
- Ohm's law
- resistance
- voltage

Introduction

When lightning discharges static electricity, it transfers a great deal of electric charge all at once. Such a sudden and large discharge of electricity isn't useful. You can't plug a toaster into a lightning bolt! To power appliances and other electric devices, you need a source of electricity that provides a relatively small amount of continuously flowing electric charges. The solution is an electric current.

Introduction to Electric Current

Electric current is a continuous flow of electric charges. Current is measured as the amount of charge that flows past a given point in a certain amount of time. The SI unit for electric current is the ampere (A), or amp. Electric current may flow in just one direction, or it may keep reversing direction.

- When current flows in just one direction, it is called **direct current (DC)**. The current that flows through a battery-powered flashlight is direct current.
- When current keeps reversing direction, it is called **alternating current (AC)**. The current that runs through the wires in your home is alternating current.

Graphs of both types of current are shown in **Figure 23.10**. You can watch an animation of both types at this URL: <http://www.youtube.com/watch?v=JZjMuIH0Beg> (0:10).



MEDIA

Click image to the left for more content.

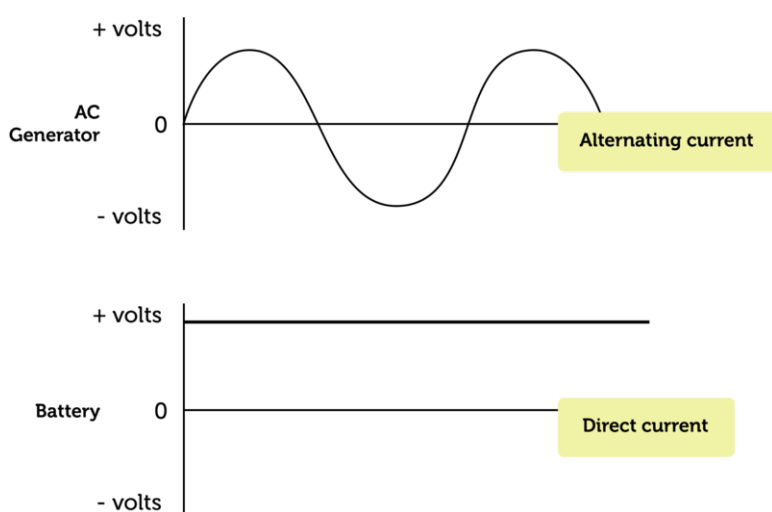

FIGURE 23.10

Direct current flows in one direction only, whereas alternating current keeps reversing direction.

Explaining Electric Current

Why do charges flow in an electric current? The answer has to do with electric potential energy. Potential energy is stored energy that an object has due to its position or shape. An electric charge has potential energy because of its position in an electric field. For example, when two negative charges are close together, they have potential energy because they repel each other and have the potential to push apart. If the charges move apart, their potential energy decreases. Electric charges always move spontaneously from a position where they have higher potential energy to a position where their potential energy is lower. This is similar to water falling over a dam from an area of higher to lower potential energy due to gravity.

In general, for an electric charge to move from one position to another, there must be a difference in electric potential energy between the two positions. The difference in electric potential energy is called potential difference, or **voltage**. Voltage is measured in an SI unit called the volt (V). For example, the terminals of the car battery in **Figure 23.11** have a potential difference of 12 volts. This difference in voltage results in a spontaneous flow of charges, or electric current.

**FIGURE 23.11**

Most car batteries, like the one pictured here, are 12-volt batteries.

Sources of Voltage

Batteries like the one in **Figure 23.11** are one of several possible sources of voltage needed to produce electric current. Sources of voltage include generators, chemical cells, and solar cells.

- Generators change the kinetic energy of a spinning turbine to electrical energy in a process called electromagnetic induction. You can read about generators and how they work in the chapter "Electromagnetism."
- Chemical and solar cells are devices that change chemical or light energy to electrical energy. You can read about both types of cells and how they work below.

Chemical Cells

Chemical cells are found in batteries. They produce voltage by means of chemical reactions. A chemical cell has two electrodes, which are strips made of different materials, such as zinc and carbon (see **Figure 23.12**). The electrodes are suspended in an electrolyte. An electrolyte is a substance containing free ions that can carry electric current. The electrolyte may be either a paste, in which case the cell is called a dry cell, or a liquid, in which case the cell is called a wet cell. Flashlight batteries contain dry cells. Car batteries contain wet cells. Animations at the URL below show how batteries work.

<http://www.youtube.com/watch?v=EJeAuQ7pkpc>

Both dry and wet cells work the same basic way. The electrodes react chemically with the electrolyte, causing one electrode to give up electrons and the other electrode to accept electrons. In the case of zinc and carbon electrodes, the zinc electrode attracts electrons and becomes negatively charged, while the carbon electrode gives up electrons and becomes positively charged. Electrons flow through the electrolyte from the negative to positive electrode. If wires are used to connect the two electrodes at their terminal ends, electric current will flow through the wires and can be used to power a light bulb or other electric device.

Solar Cells

Solar cells convert the energy in sunlight to electrical energy. They contain a material such as silicon that absorbs light energy and gives off electrons. The electrons flow and create electric current. **Figure 23.13** and the animation at the URL below show how a solar cell uses light energy to produce electric current and power a light bulb. Many calculators and other devices are also powered by solar cells.

<http://www.suntreksolar.com/solarElectricity/howCellsWork.asp>

How a Battery Works

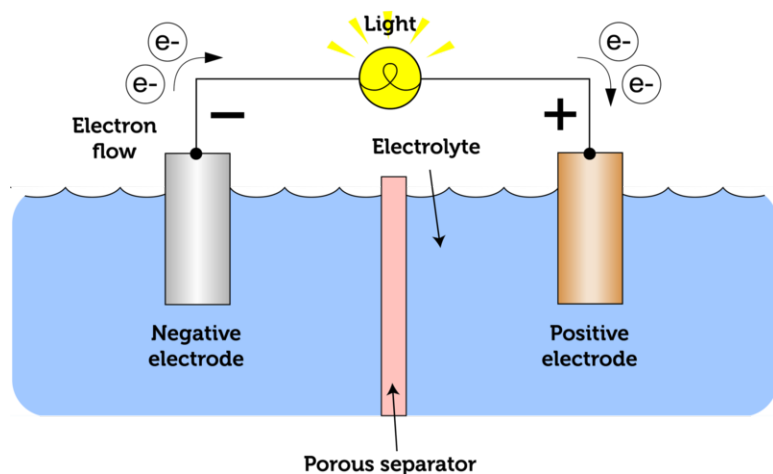

FIGURE 23.12

The simplest type of battery contains a single cell. The electrodes extend out of the battery for the attachment of wires that carry the current.

How a PV Cell Works

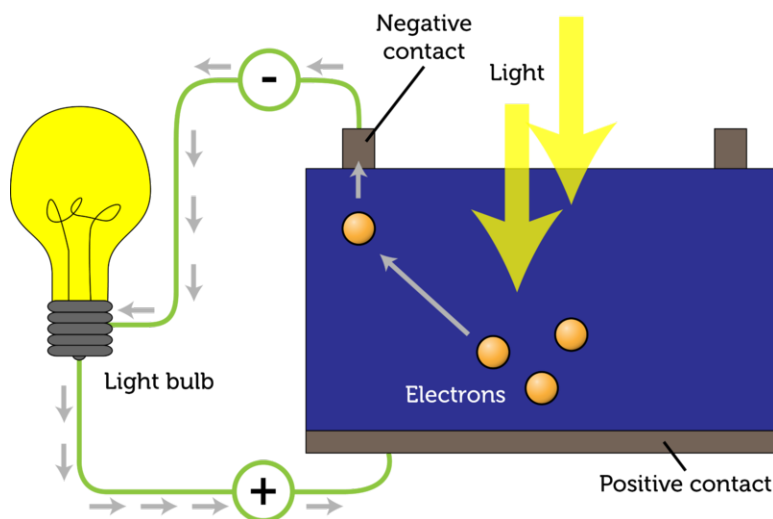

FIGURE 23.13

A solar cell is also called a photovoltaic (PV) cell because it uses light ("photo-") to produce voltage ("-voltaic"). The contacts in a PV cell are like the terminals in a chemical cell. One contact is negative and the other contact is positive, creating a difference in electric potential, or voltage, which produces electric current.

Electric Current and Materials

Electric current cannot travel through empty space. It needs a material through which to travel. However, when current travels through a material, the flowing electrons collide with particles of the material, and this creates resistance.

Resistance

Resistance is opposition to the flow of electric charges that occurs when electric current travels through matter. The SI unit of resistance is the ohm (named for the scientist Georg Ohm, whom you can read about below). Resistance is

caused by electrons in a current bumping into electrons and ions in the matter through which the current is flowing. Resistance is similar to the friction that resists the movement of one surface as it slides over another. Resistance reduces the amount of current that can travel through the material because some of the electrical energy is converted to other forms of energy. For example, when electric current flows through the tungsten wire inside an incandescent light bulb, the tungsten resists the flow of electric charge, and some of the electrical energy is converted to light and thermal energy.

Electric Conductors and Insulators

Some materials resist the flow of electric current more or less than other materials do.

- Materials that have low resistance to electric current are called **electric conductors**. Many metals—including copper, aluminum, and steel—are good conductors of electricity. Water that has even a tiny amount of impurities in it is an electric conductor as well.
- Materials that have high resistance to electric current are called **electric insulators**. Wood, rubber, and plastic are examples of electric insulators. Dry air is also an electric insulator.

You probably know that electric wires are made of metal and coated with rubber or plastic (see **Figure 23.14**). Now you know why. Metals are good electric conductors, so they offer little resistance and allow most of the current to pass through. Rubber and plastic are good insulators, so they offer a lot of resistance and allow little current to pass through. When more than one material is available for electric current to flow through, the current always travels through the material with the least resistance. That's why all the current passes through a metal wire and none flows through its rubber or plastic coating.

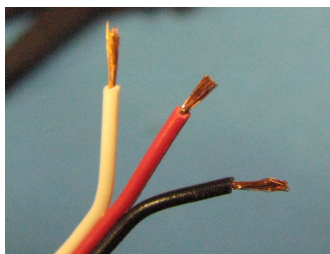

FIGURE 23.14

These electric cables are made of copper wires surrounded by a rubber coating.

Properties that Affect Resistance

For a given material, three properties of the material determine how resistant it is to electric current: length, width, and temperature. Consider an electric wire like one of the wires in **Figure 23.14**.

- A longer wire has more resistance. Current must travel farther, so there are more chances for it to collide with particles of wire.
- A wider wire has less resistance. A given amount of current has more room to flow through a wider wire.
- A cooler wire has less resistance than a warmer wire. Cooler particles have less kinetic energy, so they move more slowly. Current is less likely to collide with slowly moving particles. Materials called superconductors have virtually no resistance when they are cooled to extremely low temperatures. You can learn more about superconductors at this URL: http://www.dailymotion.com/video/x29bbd_superconductors_tech .

Ohm's Law

Voltage, or a difference in electric potential energy, is needed for electric current to flow. As you might have guessed, greater voltage results in more current. Resistance, on the other hand, opposes the flow of electric current, so greater resistance results in less current. These relationships between current, voltage, and resistance were first demonstrated by a German scientist named Georg Ohm in the early 1800s, so they are referred to as **Ohm's law**. Ohm's law can be represented by the following equation.

$$\text{Current (amps)} = \frac{\text{Voltage (volts)}}{\text{Resistance (ohms)}}$$

Understanding Ohm's Law

You may have a better understanding of Ohm's law if you compare current flowing through a wire from a battery to water flowing through a garden hose from a tap. Increasing voltage is like opening the tap wider. When the tap is opened wider, more water flows through the hose. This is like an increase in current. Stepping on the hose makes it harder for the water to pass through. This is like increasing resistance, which causes less current to flow through a material. Still not sure about the relationship among voltage, current, and resistance? Watch the video at this URL: <http://www.youtube.com/watch?v=KvVTh3ak5dQ>



MEDIA

Click image to the left for more content.

Using Ohm's Law to Calculate Current

You can use the equation for current (above) to calculate the amount of current flowing through a material when voltage and resistance are known. Consider an electric wire that is connected to a 12-volt battery. If the wire has a resistance of 3 ohms, how much current is flowing through the wire?

$$\text{Current} = \frac{12 \text{ volts}}{3 \text{ ohms}} = 4 \text{ amps}$$

You Try It!

Problem: A 120-volt voltage source is connected to a wire with 20 ohms of resistance. How much current flows through the wire?

Lesson Summary

- Electric current is a continuous flow of electric charge. It is measured in amperes (A). Direct current (DC) flows in just one direction. Alternating current (AC) keeps reversing direction.

- Electric current occurs whenever there is a difference in electric potential energy, or voltage. Voltage is measured in volts (V).
- Sources of voltage include electric generators and cells. Electric generators change kinetic energy to electrical energy. Chemical cells change chemical energy to electrical energy, and solar cells change solar energy to electrical energy.
- Electric current needs a material through which to travel, but particles of the material may resist the flow of current. Materials differ in how much they resist electric current. Materials with low resistance are called electric conductors, and materials with high resistance are called electric insulators.
- According to Ohm's law, current increases when voltage increases or resistance decreases. Current can be calculated as voltage divided by resistance.

Lesson Review Questions

Recall

1. What is electric current?
2. What is the difference between direct and alternating current?
3. Define voltage.
4. List three sources of voltage.
5. Identify three properties that affect the resistance of a given material.

Apply Concepts

6. A 12-volt battery is connected to a light bulb by wires. The wires and light bulb together have 6 ohms of resistance. How many amps of current are flowing through the wires?

Think Critically

7. Explain how voltage is related to electric current.
8. Compare and contrast electric conductors and electric insulators. Give an example of each.

Points to Consider

In this lesson, you learned about electric current. The next lesson, "Electric Circuits," focuses on the path that electric current travels. Think about a ceiling light with a wall switch. You probably have several in your home.

- What path does current travel to get from the switch on the wall to the light on the ceiling?
- How do you think the switch controls the flow of current to the light?

23.3 Electric Circuits

Lesson Objectives

- Identify the parts of an electric circuit.
- Define electric power, and state how to calculate electrical energy use.
- Identify electric safety features and how to use electricity safely.

Lesson Vocabulary

- electric circuit
- electric power
- parallel circuit
- series circuit

Introduction

Look at the battery and light bulb in **Figure 23.15**. The light bulb works and it's connected to the battery, but it won't light. The problem is the loose wire on the left. It must be connected to the positive terminal of the battery in order for the bulb to light up. The reason? Electric current can flow through a material such as a wire only if the material forms a closed loop. Charges must have an unbroken path to follow between the positively and negatively charged parts of the voltage source, in this case, the battery.

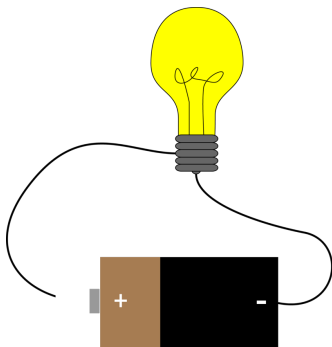

FIGURE 23.15

Electric current cannot flow through an open circuit.

Electric Circuit Basics

A closed loop through which current can flow is called an **electric circuit**. In homes in the U.S., most electric circuits have a voltage of 120 volts. The amount of current (amps) a circuit carries depends on the number and power of electrical devices connected to the circuit. But home circuits generally have a safe upper limit of about 20 or 30 amps.

Parts of an Electric Circuit

All electric circuits have at least two parts: a voltage source and a conductor.

- The voltage source of the circuit in **Figure 23.16** is a battery. In a home circuit, the source of voltage is an electric power plant, which may supply electric current to many homes and businesses in a community or even to many communities.
- The conductor in most circuits consists of one or more wires. The conductor must form a closed loop from the source of voltage and back again. In **Figure 23.16**, the wires are connected to both terminals of the battery, so they form a closed loop.

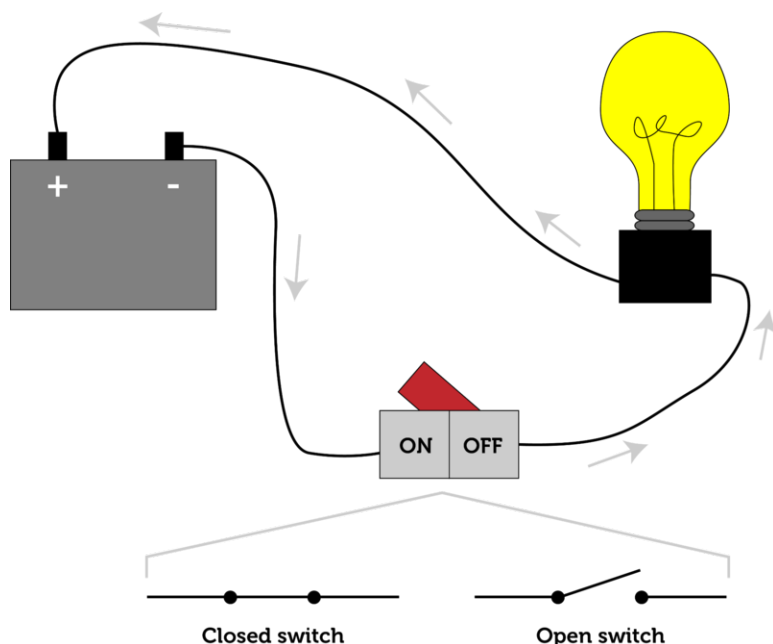

FIGURE 23.16

A circuit must be closed for electric devices such as light bulbs to work. The arrows in the diagram show the direction in which electrons flow through the circuit. The current is considered to flow in the opposite direction.

The circuit in **Figure 23.16** also has two other parts: a light bulb and a switch. You can see a simple animation of a circuit like this at the URL below.

<http://www.rkm.com.au/animations/animation-electrical-circuit.html>

- Most circuits have devices such as light bulbs that convert electric energy to other forms of energy. In the case of a light bulb, electricity is converted to light and thermal energy.
- Many circuits have switches to control the flow of current through the circuit. When the switch is turned on, the circuit is closed and current can flow through it. When the switch is turned off, the circuit is open and current cannot flow through it.

Circuit Diagrams

When a contractor builds a new home, she uses a set of plans called blueprints that show her how to build the house. The blueprints include circuit diagrams that show how the wiring and other electrical components are to be installed in order to supply current to appliances, lights, and other electrical devices in the home. You can see an example of a very simple circuit diagram in **Figure 23.17**. Different parts of the circuit are represented by standard symbols, as defined in the figure. An ammeter measures the flow of current through the circuit, and a voltmeter measures the voltage. A resistor is any device that converts some of the electricity to other forms of energy. It could be a light bulb, doorbell, or similar device.

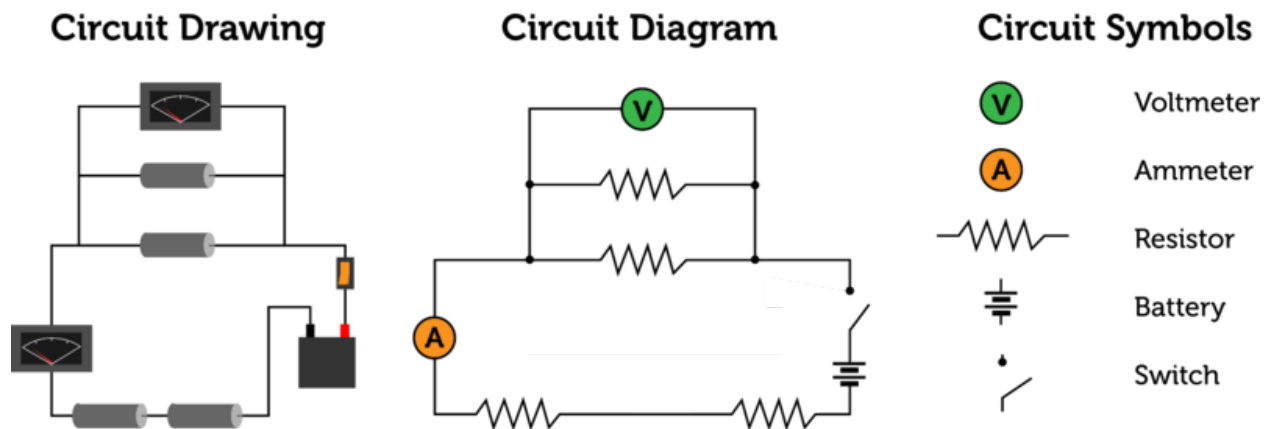

FIGURE 23.17

The circuit diagram on the right represents the circuit drawing on the left. To the right are some of the standard symbols used in circuit diagrams.

Series and Parallel Circuits

There are two basic types of electric circuits, called series and parallel circuits. They differ in the number of loops through which current can flow. You can see an example of each type of circuit in **Figure 23.18**.

- A **series circuit** has only one loop through which current can flow. If the circuit is interrupted at any point in the loop, no current can flow through the circuit and no devices in the circuit will work. In the series circuit in **Figure 23.18**, if one light bulb burns out the other light bulb will not work because it won't receive any current. Series circuits are commonly used in flashlights. You can see an animation of a series circuit at this URL: <http://regentsprep.org/regents/physics/phys03/bsercir/default.htm> .
- A **parallel circuit** has two (or more) loops through which current can flow. If the circuit is interrupted in one of the loops, current can still flow through the other loop(s). For example, if one light bulb burns out in the parallel circuit in **Figure 23.18**, the other light bulb will still work because current can by-pass the burned-out bulb. The wiring in a house consists of parallel circuits. You can see an animation of a parallel circuit at this URL: <http://regentsprep.org/regents/physics/phys03/bsercir/default.htm> .

Series Circuit

Circuit Drawing

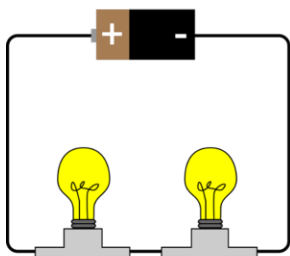

Circuit Diagram

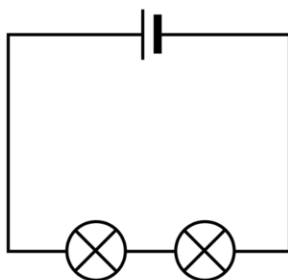

Parallel Circuit

Circuit Drawing

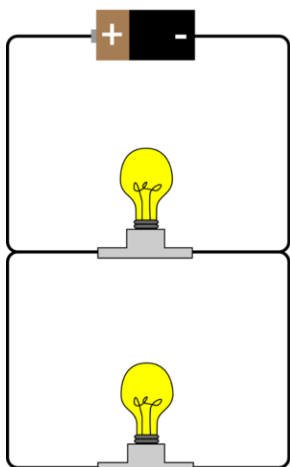

Circuit Diagram

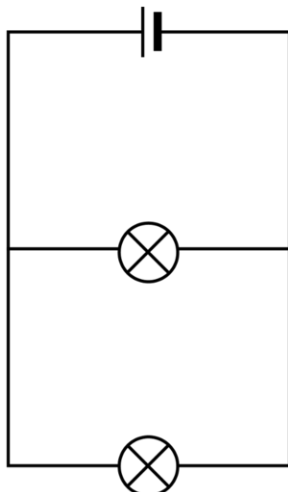

FIGURE 23.18

Series and parallel circuits differ in the number of loops they contain.

Electric Power and Electrical Energy Use

We use electricity for many purposes. Devices such as lights, stoves, and stereos all use electricity and convert it to energy in other forms. However, devices may vary in how quickly they change electricity to other forms of energy.

Electric Power

The rate at which a device changes electric current to another form of energy is called **electric power**. The SI unit of power—including electric power—is the watt. A watt equals 1 joule of energy per second. High wattages are often expressed in kilowatts, where 1 kilowatt equals 1000 watts. The power of an electric device, such as a microwave, can be calculated if you know the current and voltage of the circuit. This equation shows how power, current, and voltage are related:

$$\text{Power (watts)} = \text{Current (amps)} \times \text{Voltage (volts)}$$

Consider a microwave that is plugged into a home circuit. Assume the microwave is the only device connected to the circuit. If the voltage of the circuit is 120 volts and it carries 10 amps of current, then the power of the microwave is:

$$\text{Power} = 120 \text{ volts} \times 10 \text{ amps} = 1200 \text{ watts, or } 1.2 \text{ kilowatts}$$

You Try It!

Problem: A hair dryer is connected to a 120-volt circuit that carries 12 amps of current. What is the power of the hair dryer in kilowatts?

Electrical Energy Use

Did you ever wonder how much electrical energy it takes to use an appliance such as a microwave or hair dryer? Electrical energy use depends on the power of the appliance and how long it is used. It can be represented by the equation:

$$\text{Electrical Energy} = \text{Power} \times \text{Time}$$

Suppose you use a 1.2-kilowatt microwave for 5 minutes ($\frac{1}{12}$ hour). Then the energy used would be:

$$\text{Electrical Energy} = 1.2 \text{ kilowatts} \times \frac{1}{12} \text{ hour} = 0.1 \text{ kilowatt-hours}$$

Electrical energy use is typically expressed in kilowatt-hours, as in this example. How much energy is this? One kilowatt-hour equals 3.6 million joules of energy. Therefore, the 0.1 kilowatt-hours used by the microwave equals 0.36 million joules of energy.

You Try It!

Problem: A family watches television for an average of 2 hours per day. The television has 0.12 kilowatts of power. How much electrical energy does the family use watching television each day?

Electric Safety

Electricity is dangerous. Contact with electric current can cause severe burns and even death. Electricity can also cause serious fires. A common cause of electric hazards and fires is a short circuit.

How a Short Circuit Occurs

An electric cord contains two wires. One wire carries current from the outlet to the appliance or other electric device, and one wire carries current back to the outlet. Did you ever see an old appliance with a damaged cord, like the one in **Figure 23.19**? A damaged electric cord can cause a severe shock if it allows current to pass from the cord to a person who touches it. A damaged cord can also cause a short circuit. A short circuit occurs when electric current follows a shorter path than the intended loop of the circuit. For example, if the two wires in a damaged cord come into contact with each other, current flows from one wire to the other and bypasses the appliance. This may cause the wires to overheat and start a fire.

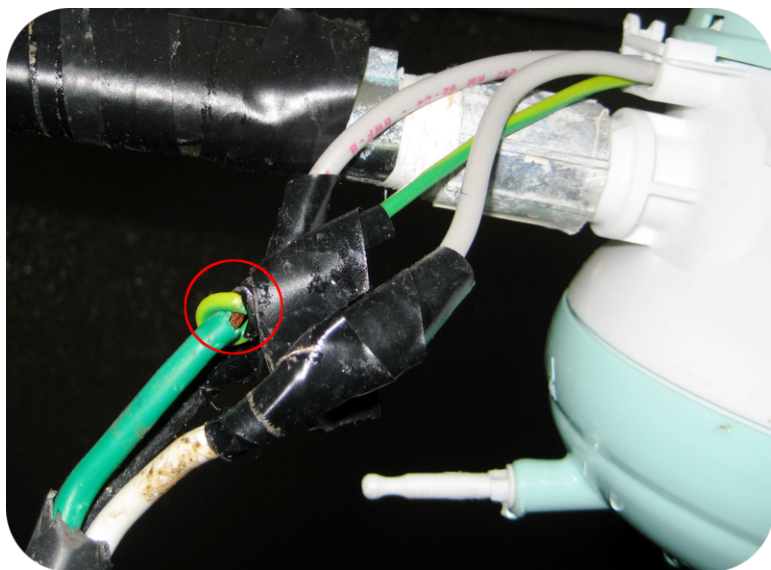

FIGURE 23.19

A damaged electric cord is a serious hazard. How can it cause an electric short?

Electric Safety Features

Because electricity can be so dangerous, safety features are built into electric circuits and devices. They include three-prong plugs, circuit breakers, and GFCI outlets. Each feature is described and illustrated in **Table 23.1**. You can learn more about electric safety features in the home by watching the video at this URL: http://www.dailymotion.com/video/x6fg5i_basics-of-your-home-s-electrical-sy_school .

TABLE 23.1: Can you find one or more examples of these electric safety features in your home?



Electric Safety Feature	Description
<p>Three-Prong Plug</p> 	<p>A three-prong plug is generally used on metal appliances. The two flat prongs carry current to and from the appliance. The round prong is for safety. It connects with a wire inside the outlet that goes down into the ground. If any stray current leaks from the circuit or if there is a short circuit, the ground wire carries the current into the ground, which harmlessly absorbs it.</p>
<p>Circuit Breaker</p> 	<p>A circuit breaker is a switch that automatically opens a circuit if too much current flows through it. This could happen if too many electric devices are plugged into the circuit or if there is an electric short. Once the problem is resolved, the circuit breaker can be switched back on to close the circuit. Circuit breakers are generally found in a breaker box that controls all the circuits in a building.</p>

TABLE 23.1: (continued)

Electric Safety Feature	Description
<p data-bbox="159 233 321 262">GFCI Outlet</p> 	<p data-bbox="824 233 1468 596">GFCI stands for ground-fault circuit interrupter. GFCI outlets are typically found in bathrooms and kitchens where the use of water poses a risk of shock (because water is a good electric conductor). A GFCI outlet contains a device that monitors the amounts of current leaving and returning to the outlet. If less current is returning than leaving, this means that current is escaping. When this occurs, a tiny circuit breaker in the outlet opens the circuit. The breaker can be reset by pushing a button on the outlet cover.</p>

Using Electricity Safely

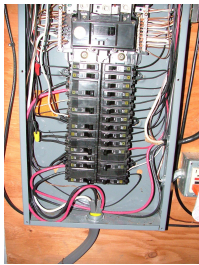
Even with electric safety features, electricity is still dangerous if it is not used safely. Follow the safety rules below to reduce the risk of injury or fire from electricity.

- Never mix electricity and water. Don't turn on or plug in electric lights or appliances when your hands are wet, you are standing in water, or you are in the shower or bathtub. The current could flow through the water—and you—because water is a very good electric conductor.
- Never overload circuits. Avoid plugging too many devices into one outlet or extension cord. The more devices that are plugged in, the more current the circuit carries. Too much current can overheat a circuit and start a fire.
- Never use devices with damaged cords or plugs. They can cause shocks, shorts, and fires.
- Never put anything except plugs into electric outlets. Plugging in other objects is likely to cause a serious shock that could be fatal.
- Never go near fallen electric lines. They could be carrying a lot of current. Report fallen lines to the electric company as soon as possible.

Lesson Summary

- An electric circuit is a closed loop through which electric current can flow. A circuit must include a source of voltage and conductors such as wires to carry the current from the source of voltage and back again. Types of circuits are series and parallel circuits.
- Electric power is the rate at which an electric device changes electric current to another form of energy. It is measured in watts or kilowatts and equals current (amps) times voltage (volts). The electrical energy used by a device is measured in kilowatt-hours and equals the power of the device (kilowatts) times the amount of time (hours) the device is used.
- Electricity is dangerous. Electric shorts can be hazardous and start fires. Electric safety features include three-prong plugs, circuit breakers, and GFCI outlets. Even with electric safety features, it's important to use electricity safely

Lesson Review Questions

Recall

1. Identify the parts of an electric circuit.
2. What is electric power?
3. What variables determine the amount of electrical energy an appliance uses?
4. Identify an electric safety feature and describe how it works.
5. List three tips to reduce the risk of injury or fire from electricity.

Apply Concepts

6. Draw a simple electric circuit that includes a battery, light bulb, and switch. Use arrows to show the flow of electrons through the circuit.
7. What is the power of an electric device that is connected to a 12-volt battery if the circuit is carrying 3 amps of current?

Think Critically

8. Compare and contrast series and parallel circuits.
9. Explain how a short circuit occurs.

Points to Consider

In this lesson, you read that electric devices convert electrical energy to other forms of energy. For example, a microwave oven converts electrical energy to electromagnetic energy in the form of microwaves. A blender converts electrical energy to sound energy and the kinetic energy of the whirring blades.

- Do you think all electric devices convert electrical energy to other forms of energy?
- Computers are familiar electric devices. Do you know how they use electric current?

23.4 Electronics

Lesson Objectives

- Describe electronic signals.
- Identify types of electronic components.
- Explain how computers use electronics.

Lesson Vocabulary

- electronics
- semiconductor

Introduction

Electric devices, such as lights and household appliances, change electric current to other forms of energy. For example, an electric stove changes electric current to thermal energy. Other common devices, such as mobile phones and computers, use electric current for another purpose: to encode information. The use of electric current for this purpose is called **electronics**.

Electronic Signals

Did you ever make a secret code? One way to make a code is to represent each letter of the alphabet by a different number. Then you can send a coded message by writing words as strings of digits. This is similar to how information is encoded using an electric current. The voltage of the current is changed rapidly and repeatedly to encode a message, called an electronic signal. There are two different types of electronic signals: analog signals and digital signals. Both are illustrated in **Figure 23.20**.

- A digital signal consists of pulses of voltage, created by repeatedly switching the current off and on. This type of signal encodes information as a string of 0s (current off) and 1s (current on). This is called a binary ("two-digit") code. DVDs, for example, encode sounds and pictures as digital signals.
- An analog signal consists of continuously changing voltage in a circuit. For example, microphones encode sounds as analog signals.

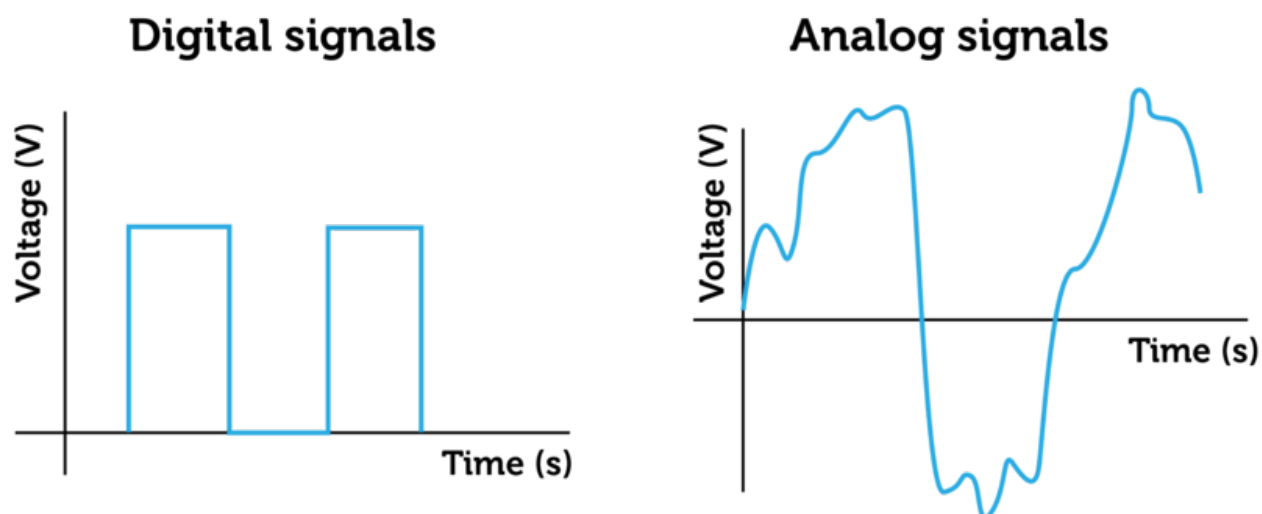

FIGURE 23.20

Digital and analog signals both change the voltage of an electric current, but they do so in different ways.

Electronic Components

Electronic components are the parts used in electronic devices such as computers. The components transmit and change electric current. They are made of materials called semiconductors.

Semiconductors

A **semiconductor** is a solid crystal—usually consisting mainly of silicon—that can conduct current better than an electric insulator but not as well as an electric conductor. Very small amounts of other elements, such as boron or phosphorus, are added to the silicon so it can conduct current. A semiconductor is illustrated in **Figure 23.21**.

There are two different types of semiconductors: n-type and p-type.

- An n-type semiconductor consists of silicon and an element such as phosphorus that gives the silicon crystal extra electrons. An n-type semiconductor is like the negative terminal in a chemical cell.
- A p-type semiconductor consists of silicon and an element such as boron that gives the silicon positively charged holes where electrons are missing. A p-type semiconductor is like the positive terminal in a chemical cell.

Types of Electronic Components

Electronic components contain many semiconductors. Types of components include diodes, transistors, and integrated circuits. Each type is described in **Table 23.2**.

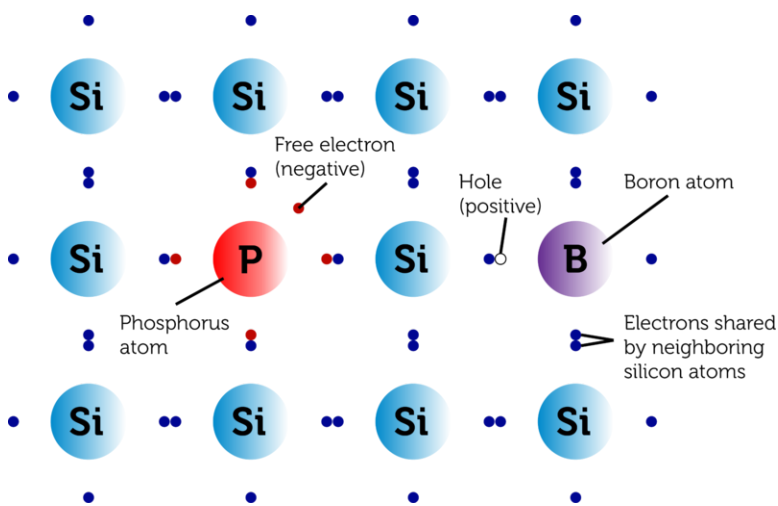

FIGURE 23.21

Each silicon atom has four valence electrons it shares with other silicon atoms in a crystal. A semiconductor is formed by replacing a few silicon atoms with other atoms that have more or less valence electrons than silicon.

TABLE 23.2: Semiconductors are the basis of each of these types of electronic components.

Electronic Component	Description
<p>Diode</p>	<p>A diode consists of a p-type and an n-type semiconductor placed side by side. When a diode is connected by leads to a source of voltage, electrons flow from the n-type to the p-type semiconductor. This is the only direction that electrons can flow in a diode. This makes a diode useful for changing alternating current to direct current.</p>
<p>Transistor</p>	<p>A transistor consists of three semiconductors, either p-n-p or n-p-n. Current can't flow through a transistor unless a small amount of current is applied to the center semiconductor (through the base). Then a much larger current can flow through the transistor from end to end (from collector to emitter). This means that a transmitter can be used as a switch, with pulses of a small current turning a larger current on and off. A transistor can also be used to increase the amount of current flowing through a circuit. You can learn more about transistors and how they work at this URL: http://www.youtube.com/watch?v=ZaBLiciesOU (1:59).</p>
<p>Integrated Circuit (Microchip)</p>	<p>An integrated circuit—also called a microchip—is a tiny, flat piece of silicon that consists of layers of electronic components such as transistors. An integrated circuit as small as a fingernail can contain millions of electronic components. Current flows extremely rapidly in an integrated circuit because it doesn't have far to travel. You can learn how microprocessors are made at this URL: http://www.youtube.com/watch?v=RHAsolyM-D4 (3:20).</p>

Electronic Devices

532

Many of the devices you commonly use are electronic. Electronic devices include computers, mobile phones, TV

- ROM (read-only memory) is a microchip that provides permanent storage. It stores important information such as start-up instructions. This memory remains even after the computer is turned off.
- RAM (random-access memory) is a microchip that temporarily stores programs and data that are currently being used. Anything stored in RAM is lost when the computer is turned off.
- The motherboard is connected to the CPU, hard drive, ROM, and RAM. It allows all these parts of the computer to receive power and communicate with one another.

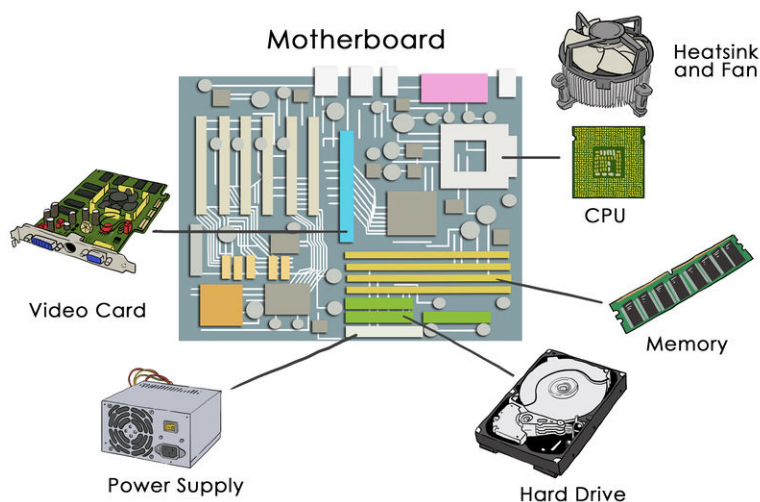
**FIGURE 23.22**

This illustration shows how the parts of a computer fit together.

Lesson Summary

- The use of electric current to encode information is called electronics. Electronic signals may be digital or analog signals. Both types of signals encode information by changing the voltage of an electric current, but they do so in different ways.
- Electronic components are the parts used in electronic devices. They are made of p-type and n-type semiconductors. Examples of electronic components include diodes, transistors, and integrated circuits (microchips).
- Electronic devices include computers, mobile phones, and TV remotes, to name just a few. All of them contain many electronic components that use electric current to encode, analyze, or transmit information.

Lesson Review Questions

Recall

1. What is an electronic signal?
2. Name two types of electronic signals. How do they differ?
3. Describe a semiconductor.
4. Identify one type of electronic component and state how it works.

Apply Concepts

5. Create an original binary code using the digits 0 and 1, and use it to encode a short message. Explain how your code is like the digital electronic code used in a computer.

Think Critically

6. Compare and contrast n-type and p-type semiconductors. Explain why both types of semiconductors must be used together in electronic components.

Points to Consider

In this chapter, you learned that electric charge is a physical property of some types of matter. In the chapter "Magnetism," you will read about another physical property of some types of matter —magnetism.

- If you've ever used a magnet, you already know something about magnetism. How would you define magnetism or explain it to someone who has no experience with magnets?
- Earth is considered to be a giant magnet. Do you know why?

For **Table 23.1**,

- Three-prong plug: Samuel M. Livingston. <http://www.flickr.com/photos/39747297@N05/5229733647/> . CC BY 2.0.
- Circuit breaker: Flickr:davef3138. <http://www.flickr.com/photos/davef3138/3573729611/> . CC BY 2.0.
- GFCI outlet: <http://www.homespothq.com/>. <http://www.flickr.com/photos/86639298@N02/8560713440/> . CC BY 2.0.

For **Table 23.2**,

- Diode: Christopher Auyeung. CK-12 Foundation. CC BY-NC 3.0.
- Transistor: Christopher Auyeung. CK-12 Foundation. CC BY-NC 3.0.
- Integrated circuit (microchip): Flickr:fdecomite. <http://www.flickr.com/photos/fdecomite/8157630452/> . CC BY 2.0.

23.5 References

1. Christopher Auyeung. [CK-12 Foundation](#) . CC BY-NC 3.0
2. Christopher Auyeung. [CK-12 Foundation](#) . CC BY-NC 3.0
3. Christopher Auyeung. [CK-12 Foundation](#) . CC BY-NC 3.0
4. Christopher Auyeung. [CK-12 Foundation](#) . CC BY-NC 3.0
5. Christopher Auyeung. [CK-12 Foundation](#) . CC BY-NC 3.0
6. Flickr:olga.palma. <http://www.flickr.com/photos/marmOta/6981900768/> . CC BY 2.0
7. Flickr:.dh. <http://www.flickr.com/photos/25968780@N03/5113783724/> . CC BY 2.0
8. Christopher Auyeung. [CK-12 Foundation](#) . CC BY-NC 3.0
9. Christopher Auyeung. [CK-12 Foundation](#) . CC BY-NC 3.0
10. Christopher Auyeung. [CK-12 Foundation](#) . CC BY-NC 3.0
11. User:Shaddack/Wikimedia Commons. <http://commons.wikimedia.org/wiki/File:Photo-CarBattery.jpg> . Public Domain
12. Christopher Auyeung, based on diagram by User:Maxx/Wikimedia Commons. Original: http://commons.wikimedia.org/wiki/File:Galvanick%C3%BD_%C4%8DI%C3%A1nek.svg . CC BY-NC 3.0 (original available in public domain)
13. Christopher Auyeung. [CK-12 Foundation](#) . CC BY-NC 3.0
14. Flickr:solarbotics. <http://www.flickr.com/photos/solarbotics/5414548592/> . CC BY 2.0
15. Christopher Auyeung. [CK-12 Foundation](#) . CC BY-NC 3.0
16. Christopher Auyeung. [CK-12 Foundation](#) . CC BY-NC 3.0
17. Christopher Auyeung. [CK-12 Foundation](#) . CC BY-NC 3.0
18. Christopher Auyeung. [CK-12 Foundation](#) . CC BY-NC 3.0
19. Mat Honan. <http://www.flickr.com/photos/honan/2225872023/> . CC BY 2.0
20. Christopher Auyeung. [CK-12 Foundation](#) . CC BY-NC 3.0
21. Christopher Auyeung. [CK-12 Foundation](#) . CC BY-NC 3.0
22. Laura Guerin. [CK-12 Foundation](#) . CC BY-NC 3.0

CHAPTER 24**Magnetism****Chapter Outline**

24.1 MAGNETS AND MAGNETISM**24.2 EARTH AS A MAGNET****24.3 REFERENCES**



The eerie green lights in the sky in this photo are called northern lights, or aurora borealis. They are caused by Earth's magnetic attraction for electrically charged particles given off by the sun. When the particles collide with gas molecules in Earth's atmosphere, the molecules give off light. The same thing also occurs in the southern hemisphere, where the lights are called southern lights, or aurora australis. Northern and southern lights are visible mainly near the poles, and they are typically green like the northern lights shown here. In this chapter, you'll learn how magnetic force can cause such spectacular effects and why Earth is a giant magnet.

Nick Russill. www.flickr.com/photos/nickrussill/150410999. CC BY 2.0.

24.1 Magnets and Magnetism

Lesson Objectives

- Identify properties of magnets.
- Explain why some materials are magnetic.

Lesson Vocabulary

- ferromagnetic material
- magnet
- magnetic domain
- magnetic field
- magnetic force
- magnetic pole
- magnetism

Introduction

The futuristic-looking train in **Figure 24.1** is called a maglev train. The word "maglev" stands for "magnetic levitation." Magnets push the train upward so it hovers, or levitates, above the track without actually touching it. This eliminates most of the friction acting against the train when it moves. Other magnets pull the train forward along the track. Because of these magnets, the train can go very fast. It can fly over the countryside at speeds up to 480 kilometers (300 miles) per hour! What are magnets and how do they exert such force? In this lesson, you'll find out.

You can watch a video introduction to lesson concepts at this URL: <http://www.youtube.com/watch?v=8Y4JSp5U82I> (10:44).

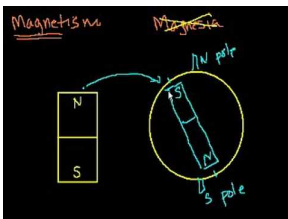

MEDIA

Click image to the left for more content.

**FIGURE 24.1**

Magnets cause this maglev train to speed along its track.

Properties of Magnets

A **magnet** is an object that attracts certain materials such as iron. You're probably familiar with common bar magnets, like the one in **Figure 24.2**. Like all magnets, this bar magnet has north and south poles and attracts objects such as paper clips that contain iron.

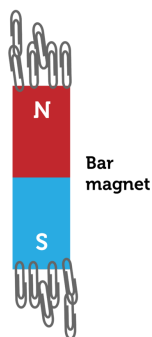
**FIGURE 24.2**

The north and south poles of a bar magnet attract paper clips.

Magnetic Poles

All magnets have two **magnetic poles**. The poles are regions where the magnet is strongest. The poles are called north and south because they always line up with Earth's north-south axis if the magnet is allowed to move freely. (Earth's axis is the imaginary line around which the planet rotates.) What do you suppose would happen if you cut the bar magnet in **Figure 24.2** in half along the line between the north and south poles? Both halves would also have north and south poles. If you cut each of the halves in half, all those pieces would have north and south poles as well. Pieces of a magnet always have both north and south poles no matter how many times you cut the magnet.

Magnetic Force

The force that a magnet exerts on certain materials is called **magnetic force**. Like electric force, magnetic force is exerted over a distance and includes forces of attraction and repulsion. North and south poles of two magnets attract each other, while two north poles or two south poles repel each other.

Magnetic Field

Like the electric field that surrounds a charged particle, a **magnetic field** surrounds a magnet. This is the area around the magnet where it exerts magnetic force. **Figure 24.3** shows the magnetic field surrounding a bar magnet. Tiny bits of iron, called iron filings, were placed under a sheet of glass. When the magnet was placed on the glass, it attracted the iron filings. The pattern of the iron filings shows the lines of force that make up the magnetic field of the magnet. The concentration of iron filings near the poles indicates that these areas exert the strongest force. To see an animated magnetic field of a bar magnet, go to this URL: <http://elgg.norfolk.e2bn.org/jsmith112/files/68/149/Bar+magnet.swf> .



FIGURE 24.3

Lines of magnetic force are revealed by the iron filings attracted to this magnet.

When two magnets are brought close together, their magnetic fields interact. You can see how in **Figure 24.4**. The drawings show how lines of force of north and south poles attract each other whereas those of two north poles repel each other. The animations at the URL below show how magnetic field lines change as two or more magnets move in relation to each other.

<http://www.coolmagnetman.com/magmotion.htm>

You can take an animated quiz to check your understanding of magnetic field interactions at this URL: <http://elgg.norfolk.e2bn.org/jsmith112/files/68/151/Law+of+magnetism.swf> .

Magnetism and Materials

Magnetism is the ability of a material to be attracted by a magnet and to act as a magnet. No doubt you've handled refrigerator magnets like the ones in **Figure 24.5**. You probably know first-hand that they stick to a metal refrigerator

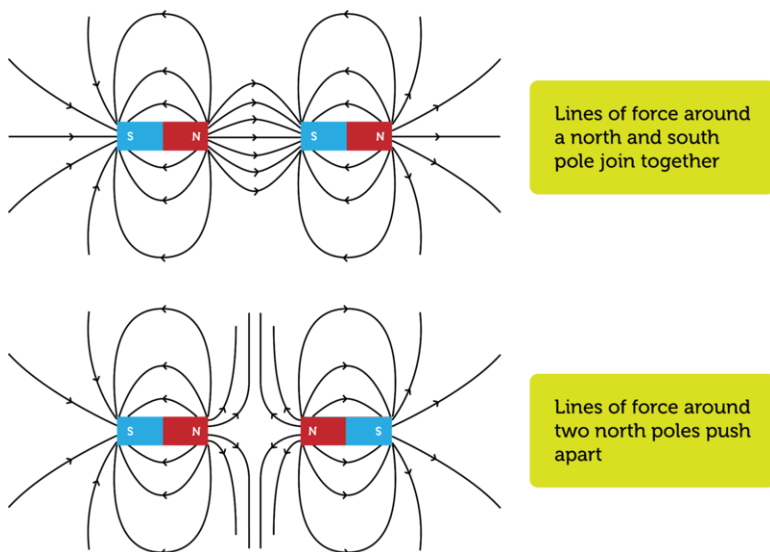

FIGURE 24.4

When it come to magnets, there is a force of attraction between opposite poles and a force of repulsion between like poles.

but not to surfaces such as wooden doors and glass windows. Wood and glass aren't attracted to a magnet, whereas the steel refrigerator is. Obviously, only certain materials respond to magnetic force.



FIGURE 24.5

Refrigerator magnets stick to a refrigerator door because it contains iron. Why won't the magnets stick to wooden cabinet doors?

What Makes a Material Magnetic?

Magnetism is due to the movement of electrons within atoms of matter. When electrons spin around the nucleus of an atom, it causes the atom to become a tiny magnet, with north and south poles and a magnetic field. In most materials, the electrons orbiting the nuclei of the atoms are arranged in such a way that the materials have no magnetic properties. Also, in most types of matter, the north and south poles of atoms point in all different directions, so overall the matter is not magnetic. Examples of nonmagnetic materials include wood, glass, plastic, paper, copper, and aluminum. These materials are not attracted to magnets and cannot become magnets.

In other materials, electrons fill the orbitals of the atoms that make up the material in a way to allow for each atom to have a tiny magnetic field, giving each atom a tiny north and south pole. There are large areas where the north and south poles of atoms are all lined up in the same direction. These areas are called **magnetic domains**. Generally, the magnetic domains point in different directions, so the material is still not magnetic. However, the material can

be magnetized by placing it in a magnetic field. When this happens, all the magnetic domains become aligned, and the material becomes a magnet. This is illustrated in **Figure 24.6**. Materials that can be magnetized are called **ferromagnetic materials**. They include iron, cobalt, and nickel.

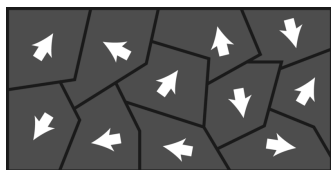

Domains before magnetization

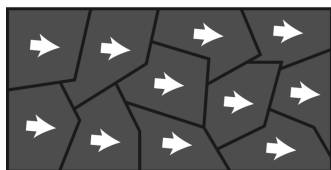

Domains after magnetization

FIGURE 24.6

Magnetic domains must be aligned by an outside magnetic field for most ferromagnetic materials to become magnets.

Temporary and Permanent Magnets

Materials that have been magnetized may become temporary or permanent magnets. An example of each type of magnet is described below. Both are demonstrated in **Figure 24.7**.

- If you bring a bar magnet close to a pile of paper clips, the paper clips will become temporarily magnetized, as all their magnetic domains align. As a result, the paper clips will stick to the magnet and also to each other. However, if you remove the paper clips from the bar magnet's magnetic field, their magnetic domains will no longer align. As a result, the paper clips will no longer be magnetized or stick together.
- If you stroke an iron nail with a bar magnet, the nail will become a permanent (or at least long-lasting) magnet. Its magnetic domains will remain aligned even after you remove it from the magnetic field of the bar magnet. Permanent magnets can be demagnetized, however, if they are dropped or heated to high temperatures. These actions move the magnetic domains out of alignment.

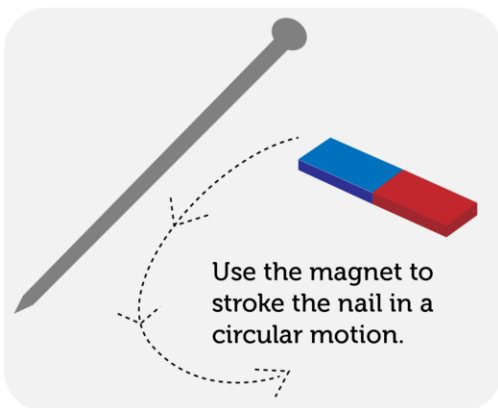

FIGURE 24.7

Paper clips become temporary magnets when placed in a magnetic field. An iron nail becomes a permanent magnet when stroked with a bar magnet.

Some materials are natural permanent magnets. The most magnetic material in nature is the mineral magnetite, also called lodestone. The magnetic domains of magnetite naturally align with Earth's axis. **Figure 24.8** shows a chunk of magnetite attracting iron nails and iron filings. The magnetic properties of magnetite have been recognized for thousands of years. The earliest compasses used magnetite pointers to show direction. The magnetite spoon compass in **Figure 24.8** dates back about 2000 years and comes from China.

Chunk of Magnetite Attracting Iron Objects



Early Chinese Magnetite Spoon Compass

**FIGURE 24.8**

Magnetite naturally attracts iron nails and filings. Its natural magnetism was discovered thousands of years ago.

Lesson Summary

- A magnet is an object that attracts certain materials such as iron. All magnets have two magnetic poles and a magnetic field over which they exert force. Opposite magnetic poles attract each other, and like magnetic poles repel each other.
- Magnetism is the ability to be attracted by a magnet and to act as a magnet. Only ferromagnetic materials have this property. They include iron, cobalt, and nickel. When these materials are magnetized, they become temporary or permanent magnets. Magnetite is a natural permanent magnet.

Lesson Review Questions

Recall

1. What is a magnet?
2. Define magnetic force.
3. Give examples of objects that are attracted by magnets.
4. Identify ferromagnetic materials.

Apply Concepts

5. Draw magnetic field lines around the bar two magnets pictured below.



6. Sasha dropped a magnet on the sidewalk. Now it no longer attracts paper clips. Apply lesson concepts to explain why.

Think Critically

7. Explain how and why a ferromagnetic material can be magnetized.

Points to Consider

The northern lights that you saw in the opening photo of this chapter are caused by Earth's magnetic field. You will read about Earth's magnetic field in the next lesson, "Earth as a Magnet."

- If you could see Earth's magnetic field, what do you think it would look like? (*Hint:* Look at **Figure 24.3**.)
- After reading this lesson, can you predict why northern lights are most likely to be visible near Earth's poles?

24.2 Earth as a Magnet

Lesson Objectives

- Describe Earth as a magnet.
- State how Earth's magnetism benefits living things.

Lesson Vocabulary

- magnetosphere

Introduction

Did you ever use a compass like the car compass in **Figure 24.9**? The pointer in a compass always points north because Earth is a giant magnet. In this lesson, you'll learn why Earth is a magnet and how Earth's magnetism benefits living things.



FIGURE 24.9

A compass pointer is aligned by Earth's magnetism to point north.

Magnet Earth

Imagine a huge bar magnet passing through Earth's axis, as illustrated in **Figure 24.10**. This is a good representation of Earth as a magnet. Like a bar magnet, Earth has north and south magnetic poles and a magnetic field.

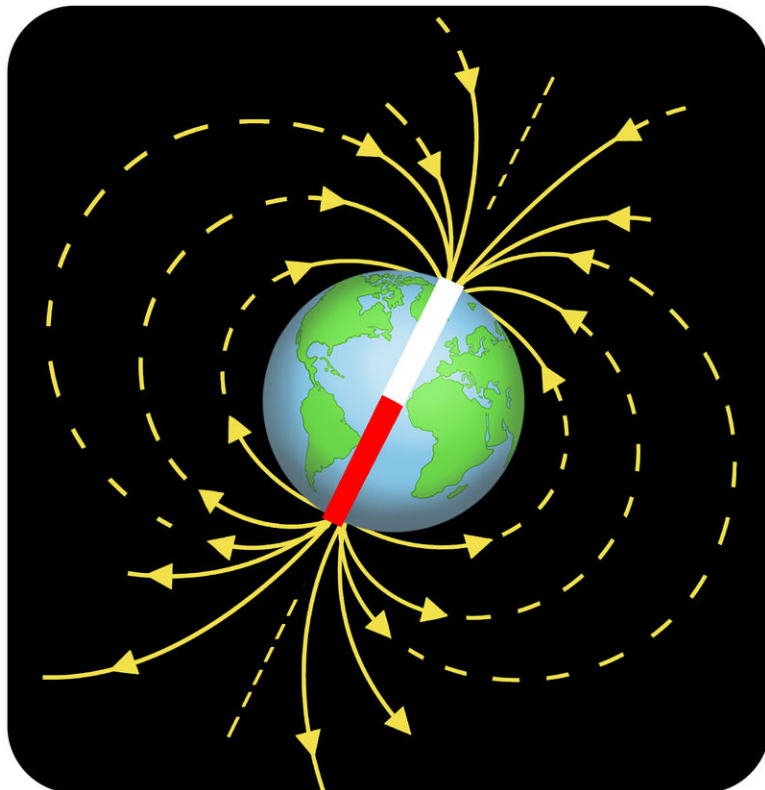

FIGURE 24.10

Earth is like a giant bar magnet.

Earth's Magnetic Poles

Although a compass always points north, it doesn't point to Earth's geographic north pole, which is located at 90° north latitude (see **Figure 24.11**). Instead, it points to Earth's magnetic north pole, which is located at about 80° north latitude. Earth's magnetic south pole is also located several degrees of latitude away from the geographic south pole.

A compass pointer has north and south poles, and its north pole points to Earth's magnetic north pole. Why does this happen if opposite poles attract? Why doesn't the compass needle point south instead? The answer may surprise you. Earth's magnetic north pole is actually the south pole of magnet Earth! It's called the magnetic north pole to avoid confusion. Because it's close to the geographic north pole, it would be confusing to call it the magnetic south pole.

Earth's Magnetic Field

Like all magnets, Earth has a magnetic field. Earth's magnetic field is called the **magnetosphere**. It is a huge region that extends outward from Earth for several thousand kilometers but is strongest at the poles. You can see the extent of the magnetosphere in **Figure 24.12**. For an animated version of the magnetosphere, watch the video at this URL:

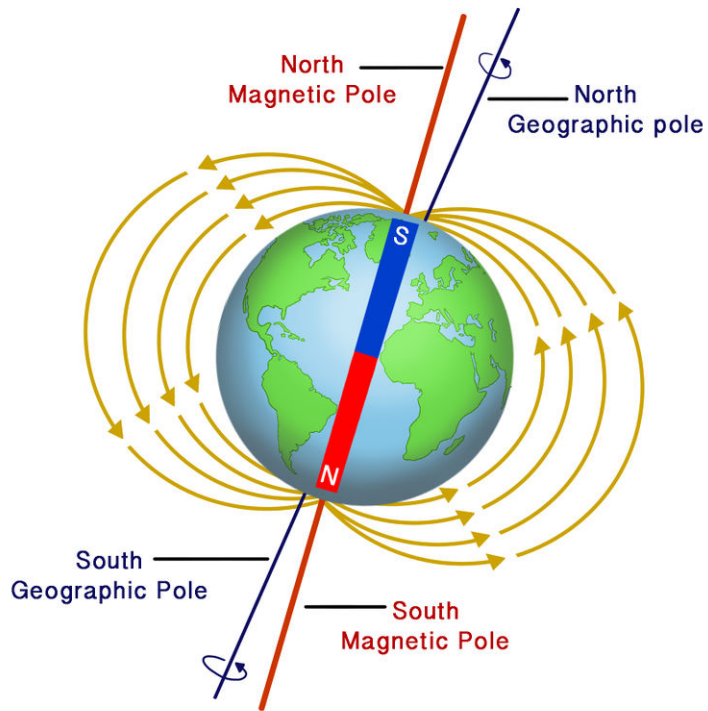
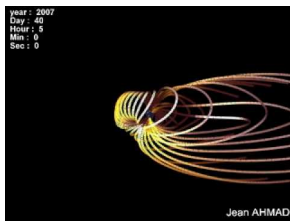

FIGURE 24.11

Earth's magnetic north pole is close to the geographic north pole.

<http://www.youtube.com/watch?v=5SXgOWYyn84> (2:48).



MEDIA

Click image to the left for more content.

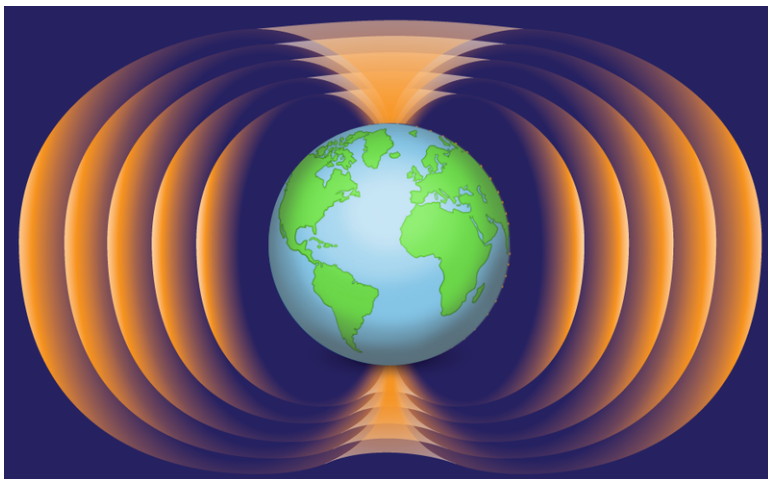

FIGURE 24.12

The magnetosphere extends outward from Earth in all directions.

Magnetic Field Reversals

Do you like to read science fiction? Science fiction writers are really creative. For example, an author might write about a time in the distant past when compasses pointed south instead of north. Actually, this idea isn't fiction—it's a fact! Earth's magnetic poles have switched places repeatedly over the past hundreds of millions of years, each time reversing Earth's magnetic field. This is illustrated in **Figure 24.13**.

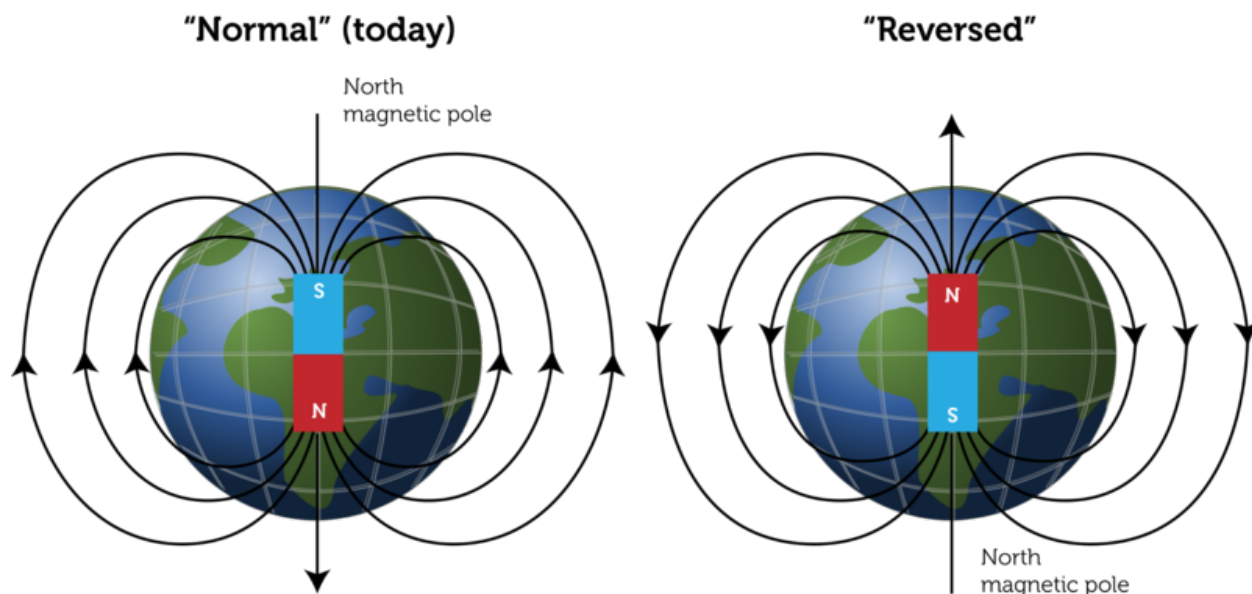

FIGURE 24.13

We think of today's magnetic pole orientation as "normal" only because that's what we are used to.

Scientists don't know for certain why magnetic reversals occur, but there is hard evidence showing that they have occurred. The evidence comes from rocks on the ocean floor. Look at **Figure 24.14**, which shows a ridge on the ocean floor. At the center of the ridge, hot magma pushes up through the crust and hardens into rock. Once the magma hardens, the alignment of magnetic domains in the rock is frozen in place forever. The newly hardened rock is then gradually pushed away from the ridge in both directions as more magma erupts and newer rock forms. Rock samples from many places on the ocean floor reveal that magnetic domains of rocks from different time periods are aligned in opposite directions. The evidence shows that Earth's magnetic field reversed hundreds of times over the last 330 million years. The last reversal was less than a million years ago. What might happen if a magnetic reversal occurred in your lifetime? How might it affect you? You can learn more about Earth's magnetic reversals at this URL: <http://www.pbs.org/wgbh/nova/earth/when-our-magnetic-field-flips.html> .

Why Is Earth a Magnet?

The idea that Earth is a magnet is far from new. It was first proposed in 1600 by a British physician named William Gilbert. However, explaining why Earth acts like a magnet is a relatively recent discovery. It had to wait until the development of technologies such as seismographs, which detect and measure earthquake waves. Then scientists could learn about Earth's inner structure (see **Figure 24.15**). They discovered that Earth has an inner and outer core and that the outer core consists of liquid metals, mainly iron and nickel. Scientists think that Earth's magnetic field is generated by the movement of charged particles through the molten metals in the outer core. The particles move

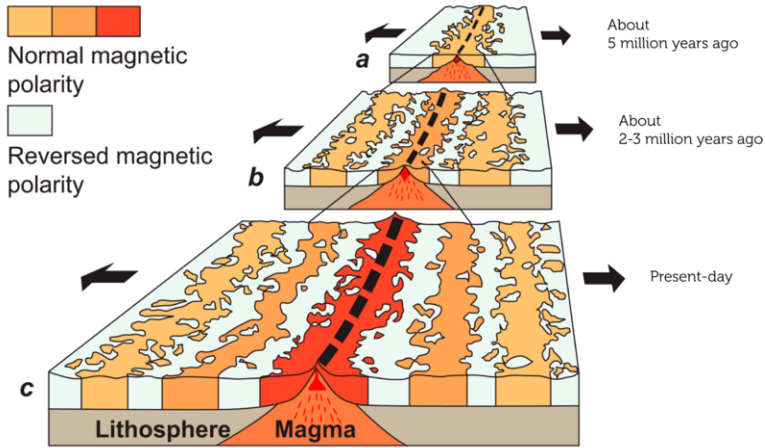
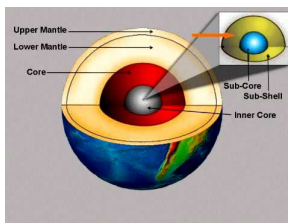

FIGURE 24.14

The alignment of magnetic domains in rocks on the ocean floor provide evidence for Earth's magnetic reversals.

as Earth spins on its axis. The video at the URL below takes a closer look at how this occurs.

<http://www.youtube.com/watch?v=O-V3yR2RZUE> (9:34)



MEDIA

Click image to the left for more content.

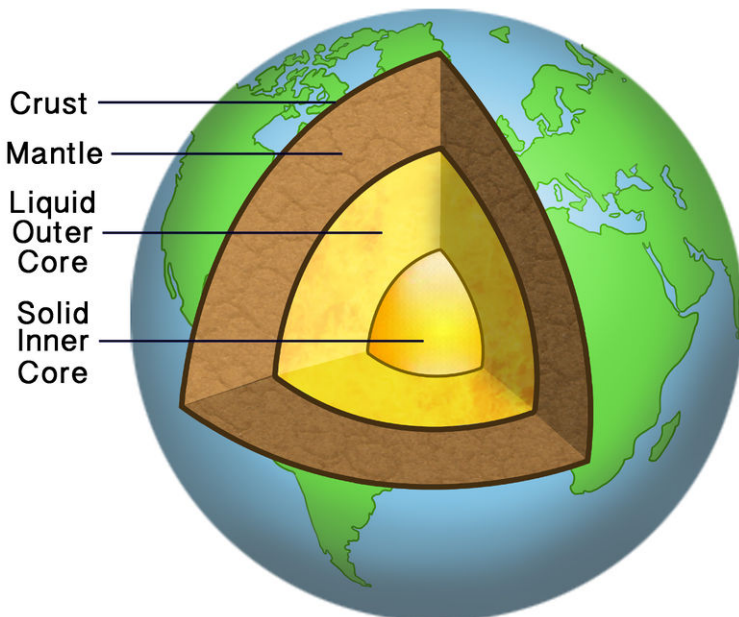

FIGURE 24.15

Charged particles flow through Earth's liquid outer core, making Earth a giant magnet.

Benefits of Earth's Magnetic Field

Earth's magnetic field helps protect Earth and its organisms from harmful particles given off by the sun. Most of the particles are attracted to the north and south magnetic poles, where Earth's magnetic field is strongest. This is also where relatively few organisms live.

Another benefit of Earth's magnetic field is its use for navigation. People use compasses to detect Earth's magnetic north pole and tell direction. Many animals have natural "compasses" that work just as well. Birds like the garden warbler in **Figure 24.16** use Earth's magnetic field to guide their annual migrations. Recent research suggests that warblers and other migrating birds have structures in their eyes that let them see Earth's magnetic field as a visual pattern. You can learn more about animals and Earth's magnetic field, including the potential effects of magnetic field reversals, at this URL: <http://www.pbs.org/wgbh/nova/nature/magnetic-impact-on-animals.html> .



FIGURE 24.16

The garden warbler flies from Europe to central Africa in the fall and returns to Europe in the spring. Its internal "compass" helps it find the way.

Lesson Summary

- Earth is a giant magnet with north and south magnetic poles and a magnetic field called the magnetosphere. Evidence in rocks shows that Earth's magnetic poles switched positions hundreds of times in the past. Scientists think that Earth's magnetic field is caused by the movement of charged particles through molten metals in the outer core.
- Earth's magnetic field helps protect Earth's surface and its organisms from harmful solar particles by pulling most of the particles toward the magnetic poles. Earth's magnetic field is also used for navigation by humans and many other animals.

Lesson Review Questions

Recall

1. What is the magnetosphere?
2. Identify evidence for magnetic reversals in Earth's past.
3. List two benefits to organisms of Earth's magnetic field.

Apply Concepts

4. Use a bar magnet, a globe or large ball, and any other props you need to demonstrate to another student how Earth is like a bar magnet.

Think Critically

5. What is the relationship between Earth's magnetic poles and Earth's geographic poles?
6. Explain why Earth is a magnet.

Points to Consider

In this chapter, you learned that Earth is a magnet because of moving charged particles in its outer core. In the chapter "Electricity," you learned that moving charged particles create electric current. The next chapter explains how electric current and magnetism are related.

- Based on what you now know about electricity and magnetism, can you predict how they are related?
- Do you think electric current could be used to create a magnet? How might this be done?

24.3 References

1. Max Talbot-Minkin. <http://www.flickr.com/photos/maxtm/6823667554/> . CC-BY 2.0
2. Christopher Auyeung. [CK-12 Foundation](#) . CC BY-NC 3.0
3. Marc Spooner. <http://www.flickr.com/photos/marcspooner/5287991784/> . CC BY 2.0
4. Christopher Auyeung. [CK-12 Foundation](#) . CC BY-NC 3.0
5. Neil Piddock (Flickr: piddy77). <http://www.flickr.com/photos/piddysplace/145287597/> . CC BY 2.0
6. Christopher Auyeung. [CK-12 Foundation](#) . CC BY-NC 3.0
7. Magnet and paperclip: User:Havelock/He.Wikipedia; Magnet and nail: Christopher Auyeung. [Magnet and paperclip](#): <http://commons.wikimedia.org/wiki/File:Magpins1.JPG>; [Magnet and nail](#): [CK-12 Foundation](#) . Magnet and paperclip: The copyright holder of this file allows anyone to use it for any purpose, provided that the copyright holder is properly attributed; Magnet and nail: CC BY-NC 3.0
8. Left: User:Teravolt/Wikipedia; Right: User:Yug/Wikimedia Commons. [Left](#): http://commons.wikimedia.org/wiki/File:Lodestone_%28black%29.jpg; [Right](#): http://commons.wikimedia.org/wiki/File:Antic_chinese_Compass.jpg . Left: CC BY 3.0; Right: Public Domain
9. Flickr:Alberto.... <http://www.flickr.com/photos/albertoalerigi/2886121661/> . CC BY 2.0
10. Laura Guerin. [CK-12 Foundation](#) . CC BY-NC 3.0
11. Laura Guerin. [CK-12 Foundation](#) . CC BY-NC 3.0
12. Laura Guerin. [CK-12 Foundation](#) . CC BY-NC 3.0
13. Christopher Auyeung (CK-12 Foundation), using Earth clip art by yeKcim from Open Clip Art Library. [Earth](#): http://commons.wikimedia.org/wiki/File:Earth_clip_art.svg . CC BY-NC 3.0 (Earth svg released into the public domain)
14. Courtesy of the U.S. Geological Survey. <http://commons.wikimedia.org/wiki/File:Oceanic.Stripe.Magnetic.Anomalies.Scheme.gif> . Public Domain
15. Laura Guerin. [CK-12 Foundation](#) . CC BY-NC 3.0
16. Flickr:Biillyboy. http://commons.wikimedia.org/wiki/File:Sylvia_borin_%28%C3%96rebro_County%29.jpg . CC BY 2.0

Chapter Outline

- 25.1 ELECTRICITY AND MAGNETISM
- 25.2 USING ELECTROMAGNETISM
- 25.3 GENERATING AND USING ELECTRICITY
- 25.4 REFERENCES



What's dangling from the end of this big crane? It seems to be a very large magnet because metal objects are sticking to it. That's exactly what it is. With the flick of a switch, the crane operator can turn on the magnet and use it to pick up objects off the ground. Then with another flick of the switch, the operator can turn off the magnet to drop the objects in the container. How does this happen? How can a magnet be turned on or off so easily? In this chapter, you'll find out.

Image copyright dvande, 2013. www.shutterstock.com. Used under license from Shutterstock.com.

25.1 Electricity and Magnetism

Lesson Objectives

- Outline how electromagnetism was discovered.
- Describe the magnetic field created by an electric current.

Lesson Vocabulary

- electromagnetism

Introduction

The crane magnet in the opening photo is an electromagnet. Like all electromagnets, its magnetism is produced by electric current. This type of magnetism is called **electromagnetism**.

Discovery of Electromagnetism

In 1820, a physicist in Denmark, named Hans Christian Oersted, discovered how electric currents and magnetic fields are related. However, it was just a lucky accident. Oersted, who is pictured in **Figure 25.1**, was presenting a demonstration to his students. Ironically, he was trying to show that electricity and magnetism are not related. He placed a wire with electric current flowing through it next to a magnet, and nothing happened. After class, a student held the wire near the magnet again, but in a different direction. To Oersted's surprise, the pointer of the magnet swung toward the wire so it was no longer pointing to Earth's magnetic north pole. Oersted was intrigued. He turned off the current in the wire to see what would happen to the magnet. The pointer swung back to its original position, pointing north again. Oersted had discovered that an electric current creates a magnetic field. The magnetic field created by the current was strong enough to attract the pointer of the nearby compass.

Oersted wanted to learn more about the magnetic field created by a current, so he placed a magnet at different locations around a wire with current flowing through it. You can see some of his results in **Figure 25.2**. They show that the magnetic field created by a current has field lines that circle around the wire. You can learn more about Oersted's investigations of current and magnetism at the URL below.

<http://www.youtube.com/watch?v=BM4m2GIId3F8> (2:00)

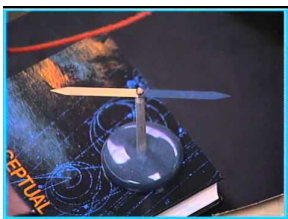

MEDIA

Click image to the left for more content.



FIGURE 25.1

Hans Christian Oersted was the scientist who discovered electromagnetism.

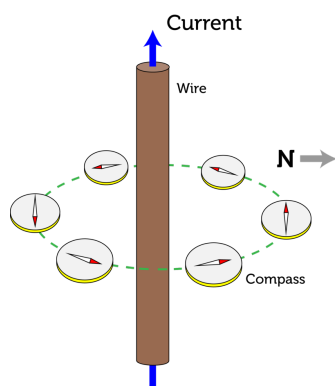

FIGURE 25.2

In Oersted's investigation, the pointer of the magnet moved continuously as it circled the wire.

Electric Currents and Magnetic Fields

The magnetic field created by a current flowing through a wire actually surrounds the wire in concentric circles. This magnetic field is stronger if more current is flowing through the wire. The direction of the magnetic field also depends on the direction that the current is flowing through the wire. A simple rule, called the right hand rule, makes it easy to find the direction of the magnetic field if the direction of the current is known. The right hand rule is illustrated in **Figure 25.3**. When the thumb of the right hand is pointing in the same direction as the current, the fingers of the right hand curl around the wire in the direction of the magnetic field. You can see the right hand rule in action at this URL: <http://www.youtube.com/watch?v=eK1Ar5WPJj8> .

Lesson Summary

- Electromagnetism is magnetism produced by an electric current. Electromagnetism was discovered by Oersted in 1820.
- The magnetic field produced by a current in a wire moves around the wire in concentric circles. More current creates a stronger magnetic field, and the direction of the current determines the direction of the magnetic field.

Right Hand Rule

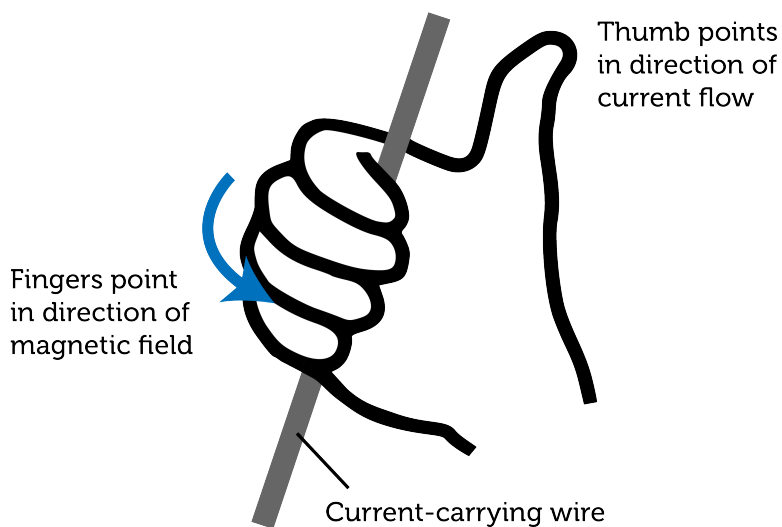

FIGURE 25.3

The right hand rule shows the direction of the magnetic field around a wire that is carrying electric current.

Lesson Review Questions

Recall

1. Define electromagnetism.
2. Describe how Oersted discovered electromagnetism.
3. What is the right hand rule?

Apply Concepts

4. The drawing below shows part of a wire that has current flowing through it. The arrow shows the direction of the current. Apply the right hand rule, and sketch the magnetic field lines around the wire.



Think Critically

5. Relate the properties of an electric current to its magnetic field.

Points to Consider

The magnetic field created by a single wire with current flowing through it is too weak to be very useful. However, technologies have been developed to make stronger electromagnetic fields. You can learn what they are in the next lesson on "Using Electromagnetism."

- What might make an electromagnetic field stronger?
- How might the wire that carries the current be arranged to increase the strength of the magnetic field?

25.2 Using Electromagnetism

Lesson Objectives

- State how a solenoid increases electromagnetic force.
- Explain why electromagnets can be very strong.
- Describe how doorbells and electric motors use electromagnetism.

Lesson Vocabulary

- electric motor
- electromagnet
- solenoid

Introduction

Do you believe in ghosts? The man in the **Figure 25.4** does. He's hoping to record sights or sounds of ghost on his video camera. The other device he's holding is an electromagnetic field detector. Ghost hunters often use detectors like this one because they believe that ghosts cause changes in electromagnetic fields. The problem for ghost hunters is that electromagnetic fields can be produced by many devices. You can read about some of them in this lesson. They may not be as exciting as ghosts, but they are a lot more useful!



FIGURE 25.4

This man is trying to detect "evidence" of a ghost.

Solenoids

A **solenoid** is a coil of wire with electric current flowing through it, giving it a magnetic field (see **Figure 25.5**). Recall that current flowing through a straight wire produces a weak electromagnetic field that circles around the wire. Current flowing through a coil of wire, in contrast, produces a magnetic field that has north and south poles like a bar magnet. The magnetic field around a coiled wire is also stronger than the magnetic field around a straight wire because each turn of the wire has its own magnetic field. Adding more turns increases the strength of the field, as does increasing the amount of current flowing through the coil. You can see an actual solenoid with a compass showing its magnetic north pole at this URL: <http://www.youtube.com/watch?v=AgZHqfIBkUI> .

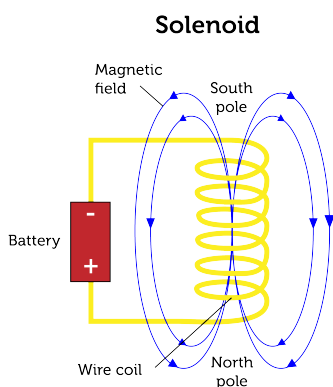

FIGURE 25.5

How does a solenoid resemble a bar magnet?

Electromagnets

Solenoids are the basis of electromagnets. An **electromagnet** is a solenoid wrapped around a bar of iron or other ferromagnetic material (see **Figure 25.6**). The electromagnetic field of the solenoid magnetizes the iron bar by aligning its magnetic domains. The combined magnetic force of the magnetized iron bar and the wire coil makes an electromagnet very strong. In fact, electromagnets are the strongest magnets made. Some of them are strong enough to lift a train. The maglev train described earlier, in the lesson "Electricity and Magnetism," contains permanent magnets. Strong electromagnets in the track repel the train magnets, causing the train to levitate above the track.

Like a solenoid, an electromagnet is stronger if there are more turns in the coil or more current is flowing through it. A bigger bar or one made of material that is easier to magnetize also increases an electromagnet's strength. You can see how to make a simple electromagnet at this URL: <http://www.youtube.com/watch?v=emlzh9XXWgQ> (4:57).



MEDIA

Click image to the left for more content.

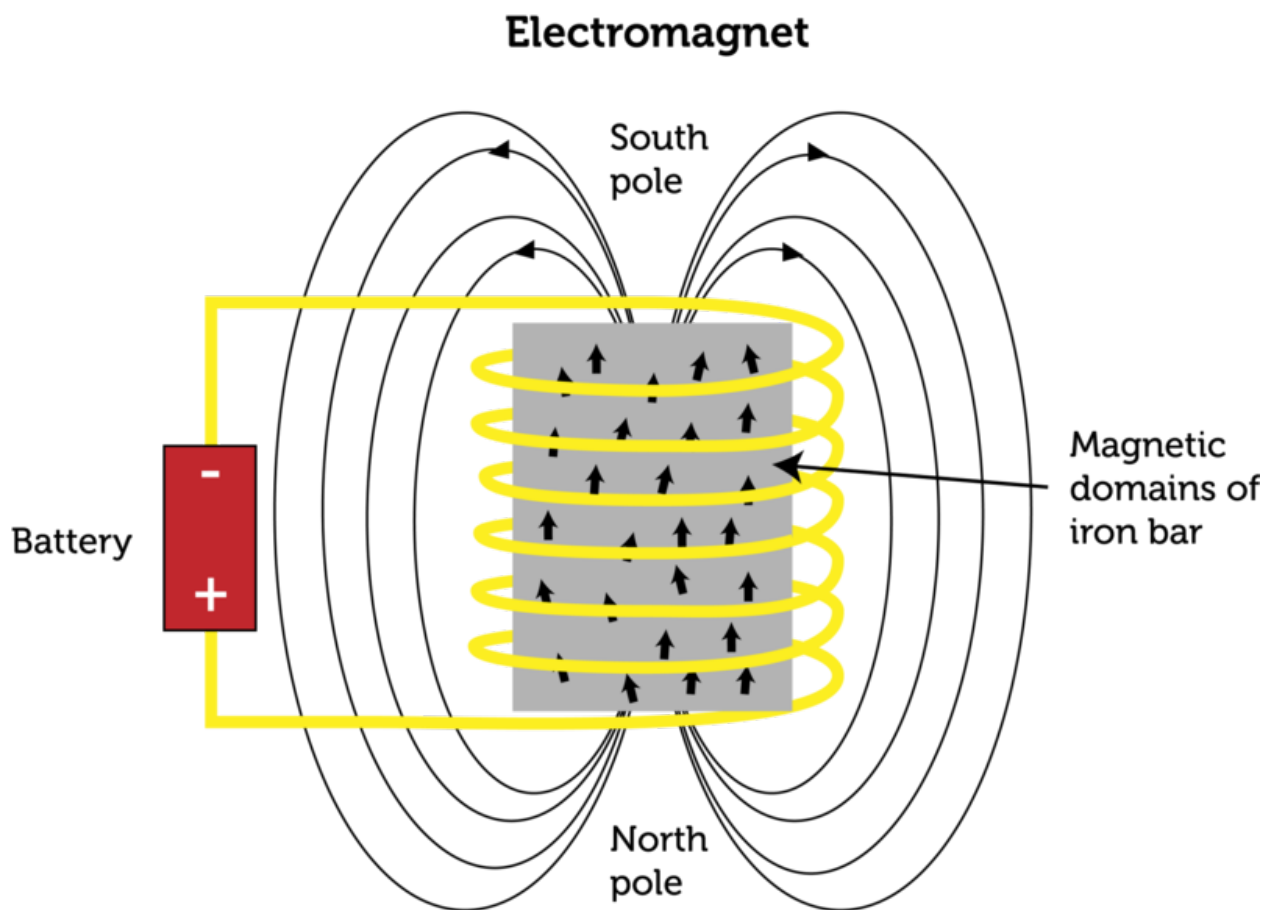
**FIGURE 25.6**

An electromagnet uses a solenoid and an iron bar to create a very strong magnetic field.

Electromagnetic Devices

Many common electric devices contain electromagnets. Some examples include hair dryers, fans, CD players, telephones, and doorbells. Most electric devices that have moving parts contain electric motors. You can read below how doorbells and electric motors use electromagnets.

How a Doorbell Works

Figure 25.7 shows a diagram of a simple doorbell. Like most doorbells, it has a button located by the front door. Pressing the button causes two electric contacts to come together and complete an electric circuit. In other words, the button is a switch. The circuit is also connected to a voltage source, an electromagnet, and the clapper of a bell. When current flows through the circuit, the electromagnet turns on, and its magnetic field attracts the clapper. This causes the clapper to hit the bell, making it ring. Because the clapper is part of the circuit, when it moves to strike the bell, it breaks the circuit. Without current flowing through the circuit, the electromagnet turns off. The clapper returns to its original position, which closes the circuit again and turns the electromagnet back on. The

electromagnet again attracts the clapper, which hits the bell once more. This sequence of events keeps repeating as long as the button by the front door is being pressed.

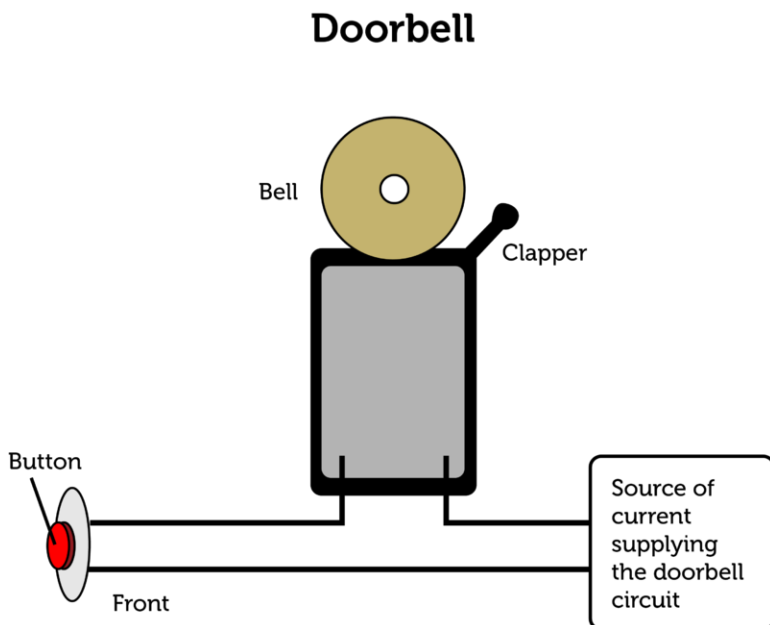
**FIGURE 25.7**

A doorbell uses an electromagnet to move the clapper of a bell.

Electric Motors

An **electric motor** is a device that uses an electromagnet to change electrical energy to kinetic energy. **Figure 25.8** shows a simple diagram of an electric motor. The motor contains an electromagnet that is connected to a shaft. When current flows through the motor, the electromagnet turns, causing the shaft to turn as well. The rotating shaft moves other parts of the device.

Why does the motor's electromagnet turn? Notice that the electromagnet is located between the north and south poles of two permanent magnets. When current flows through the electromagnet, it becomes magnetized, and its poles are repelled by the like poles of the permanent magnets. This causes the electromagnet to turn toward the unlike poles of the permanent magnets. A device called a commutator then changes the direction of the current so the poles of the electromagnet are reversed. The reversed poles are once again repelled by the like poles of the permanent magnets. This causes the electromagnet to continue to turn. These events keep repeating, so the electromagnet rotates continuously. You can make a very simple electric motor with a battery, wire, and magnet following instructions at this URL: <http://www.youtube.com/watch?v=VhaYLnjf1E> .

Lesson Summary

- A solenoid is a coil of wire with electric current flowing through it. It produces a strong magnetic field with north and south poles like a bar magnet.
- An electromagnet is a solenoid wrapped around a bar of iron or other ferromagnetic material. The magnetic field of the coil magnetizes the bar, which adds to the strength of the magnetic field. Electromagnets are the strongest magnets made.
- Many common electric devices, such as doorbells, contain electromagnets. If they have moving parts, they are likely to have an electric motor. An electric motor is a device that uses an electromagnet to change electrical

Electric Motor

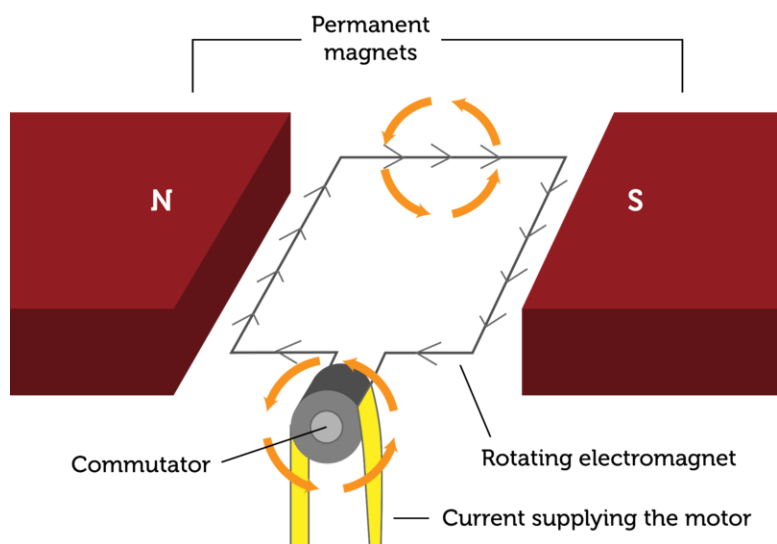

FIGURE 25.8

In this simple diagram of an electric motor, the electromagnet is represented by a rectangular wire. It actually consists of an iron bar surrounded by a wire coil.

energy to kinetic energy.

Lesson Review Questions

Recall

1. What is a solenoid?
2. What determines the strength of a solenoid's magnetic field?
3. Describe how a doorbell uses an electromagnet.

Apply Concepts

4. Draw a labeled sketch of an electric motor to show how it uses electromagnetism to convert electrical energy to kinetic energy.

Think Critically

5. Assume that an electromagnet and a solenoid have the same number of turns in their wire coil and the same amount of current flowing through the wire. Which device has the stronger magnetic field? Explain your answer.

Points to Consider

In this lesson, you saw how electric current can be used to create a strong electromagnetic field. In the next lesson, "Generating and Using Electricity," you'll find out how a magnetic field can be used to generate an electric current.

- Can you predict how this might be done?
- A device that uses a magnetic field to generate electricity is called a generator. What do you already know about generators from previous chapters? (*Hint*: Look at the figure on how energy constantly changes form in the "Introduction to Energy" chapter.)

25.3 Generating and Using Electricity

Lesson Objectives

- Describe electromagnetic induction.
- Explain how electric generators and transformers work.
- State the roles of generators and transformers in electrifying the home.

Lesson Vocabulary

- electric generator
- electric transformer
- electromagnetic induction
- Faraday's law

Introduction

You probably use many electric devices every day, including lights and appliances such as hair dryers and microwaves. Where does the electricity come from to power these devices? The answer is magnetic fields.

From Magnets to Electricity

Just about a decade after Oersted discovered that electric current produces a magnetic field, an English scientist named Michael Faraday discovered that the reverse is also true. A magnetic field produces an electric current, as long as the magnetic field is changing. This is called **Faraday's law**.

Electromagnetic Induction

The process of generating electric current with a changing magnetic field is called **electromagnetic induction**. It occurs whenever a magnetic field and an electric conductor, such as a coil of wire, move relative to one another. As long as the conductor is part of a closed circuit, current will flow through it whenever it crosses magnetic field lines. One way this can happen is pictured in **Figure 25.9**. It shows a magnet moving inside a wire coil. Another way is for the coil to move instead of the magnet.

You can watch an animated version of **Figure 25.9** at this URL: <http://jsticca.wordpress.com/2009/09/01/the-magnet-car/> .

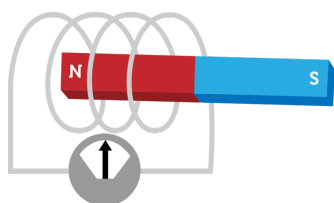

FIGURE 25.9

This simple setup shows how electromagnetic induction occurs.

The Current Produced by a Magnet

The device in the circuit in **Figure 25.9** is an ammeter. It measures the current that flows through the wire. The faster the magnet or coil moves, the greater the amount of current that is produced. If more turns were added to the coil, this would increase the strength of the magnetic field as well. If the magnet were moved back and forth repeatedly, the current would keep changing direction. In other words, alternating current would be produced. This is illustrated in **Figure 25.10**.

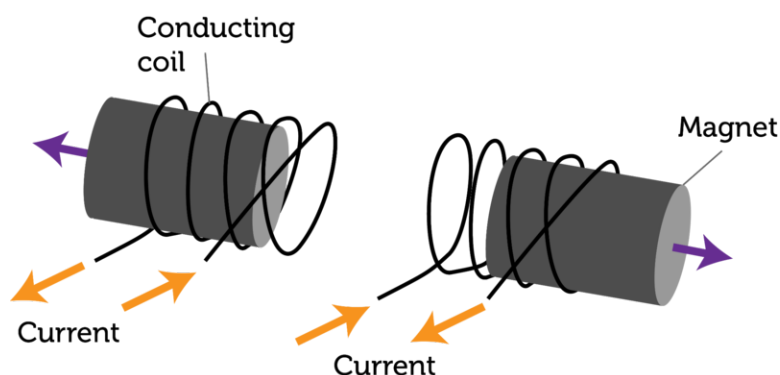

FIGURE 25.10

If a magnet is moved back and forth relative to a coil of wire, alternating current is produced.

Electric Generators and Transformers

Two important devices depend on electromagnetic induction: electric generators and electric transformers. Both devices play critical roles in producing and regulating the electric current we depend on in our daily lives.

Electric Generators

An **electric generator** is a device that changes kinetic energy to electrical energy through electromagnetic induction. A simple diagram of an electric generator is shown in **Figure 25.11**. In a generator, some form of energy is applied to turn a shaft. This causes a coil of wire to rotate between opposite poles of a magnet. Because the coil is rotating in a magnetic field, electric current is generated in the wire. If the diagram in **Figure 25.11** looks familiar to you, that's because a generator is an electric motor in reverse. Look back at the electric motor in **Figure 25.8**. If you were to mechanically turn the shaft of the motor (instead of using electromagnetism to turn it), the motor would generate electricity just like an electric generator. You can learn how to make a very simple electric generator by watching the video at the URL below. Making your own generator will help you understand how a generator works.

<http://www.youtube.com/watch?v=k7Sz8oT8ou0>

Electric Generator

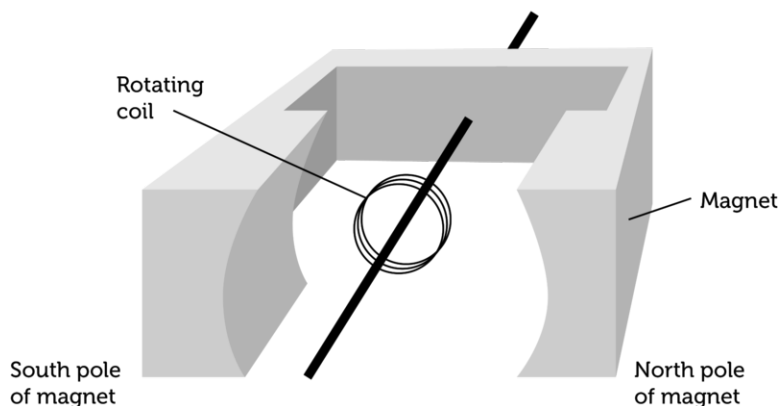

FIGURE 25.11

This diagram shows the basic parts of an electric generator. Compare the generator with the electric motor.

Generators may be set up to produce either alternating or direct current. Generators in cars and most power plants produce alternating current.

- A car generator produces electricity with some of the kinetic energy of the turning crankshaft. The electricity is used to run the car's lights, power windows, radio, and other electric devices. Some of the electricity is stored in the car's battery to provide electrical energy when the car isn't running.
- A power plant generator produces electricity with the kinetic energy of a turning turbine. The energy to turn the turbine may come from burning fuel, falling water, or some other energy source. You can see how falling water is used to generate electricity in **Figure 25.12** and in the video at this URL: <http://www.youtube.com/watch?v=cEL7yc8R42k> .

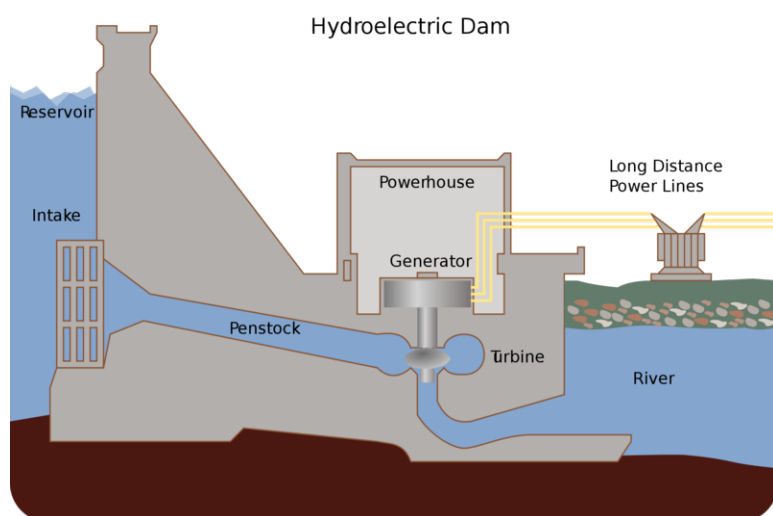

FIGURE 25.12

A hydroelectric power plant uses the kinetic energy of falling water to turn a turbine and generate electricity.

Electric Transformers

An **electric transformer** is a device that uses electromagnetic induction to change the voltage of electric current. A transformer may either increase or decrease voltage, but it only works with alternating current. You can see the

components of an electric transformer in **Figure 25.13**.

Electric Transformer

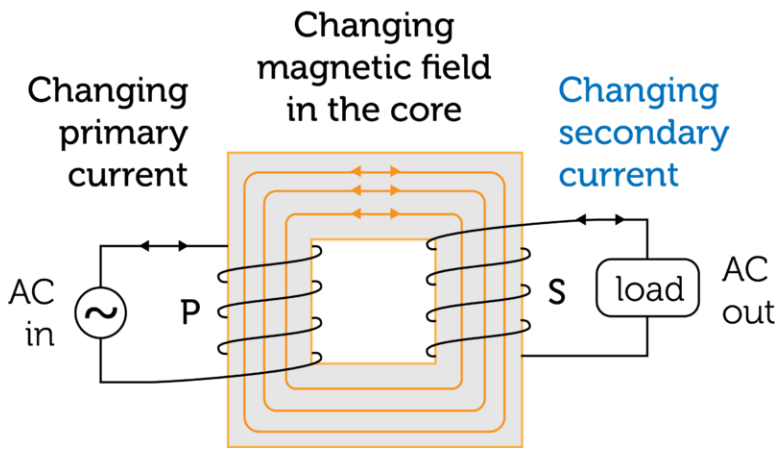

FIGURE 25.13

An electric transformer connects two circuits with an iron core that becomes an electromagnet.

As you can see in **Figure 25.13**, a transformer consists of two wire coils wrapped around an iron core. When alternating primary current passes through coil P, it magnetizes the iron core. Because the current is alternating, the magnetic field of the iron core keeps reversing. This changing magnetic field induces alternating current in coil S, which is part of another circuit. In **Figure 25.13**, coil P and coil S have the same number of turns of wire. In this case, the voltages of the primary and secondary currents are the same. However, when the two coils have different numbers of turns, the voltage of the secondary current is different than the voltage of the primary current. Both cases are illustrated in **Figure 25.14**.

- When coil S has more turns of wire than coil P, the voltage in the secondary current is greater than the voltage in the primary current. This type of transformer is called a step-up transformer.
- When coil S has fewer turns of wire than coil P, the voltage in the secondary current is less than the voltage in the primary current. This type of transformer is called a step-down transformer.

For an animation of a transformer, go to this URL: <http://www.youtube.com/watch?v=VucsoEhB0NA> .

Electrifying the Home

Power plant generators produce high-voltage electric current. Many power plants also use step-up transformers to increase the voltage of the current even more (see **Figure 25.15**). By increasing the voltage, the amount of current is decreased, so less power is lost as the electricity travels through the power lines. However, the voltage in power lines is too high to be safe for home circuits. The voltage in power lines may be as great as 750,000 volts, whereas most home circuits are 240 or 120 volts. One or more step-down transformers decrease the voltage of current before it enters the home. Other step-down transformers within the home lower the voltage of some of the home's circuits. For an overview of electric power generation, transmission, and distribution in the U.S., go to this URL: <http://www.youtube.com/watch?v=2eU3BgrmkY> .

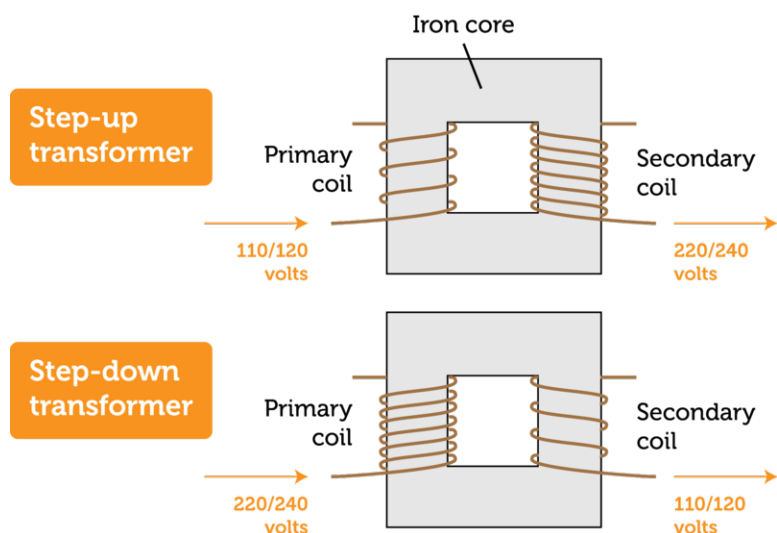

FIGURE 25.14

Whether a transformer increases or decreases voltage depends on the relative number of turns of wire in the two coils.

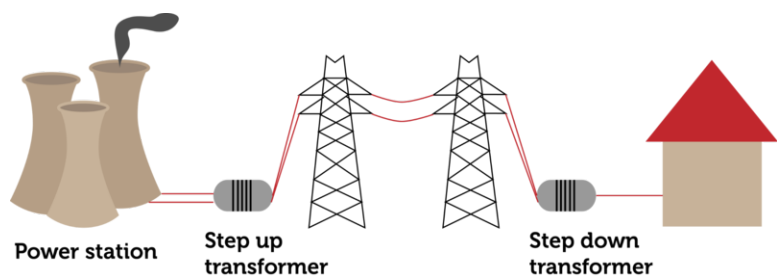

FIGURE 25.15

Transformers play an important role in supplying energy to the home. Why are both step-up and step-down transformers needed?

Lesson Summary

- A changing magnetic field produces an electric current in the process of electromagnetic induction. Current is generated whenever an electric conductor crosses magnetic field lines.
- An electric generator is a device that changes kinetic energy to electrical energy through electromagnetic induction. An electric transformer is a device that uses electromagnetic induction to change the voltage of electric current.
- Electric generators and transformers play critical roles in producing and regulating the electric current we depend on in our daily lives.

Lesson Review Questions

Recall

1. What is Faraday's law?
2. Define electromagnetic induction.
3. Describe how an electric generator uses electromagnetic induction.

Apply Concepts

4. Create a sketch to show how a coil of wire in a circuit and a bar magnet can be used to produce electric current.

Think Critically

5. Explain how an electric transformer changes the voltage of electric current. Why does a transformer work only with alternating current?

Points to Consider

This chapter explains how electric and magnetic forces are related and how they are used. Knowledge of electricity and magnetism can help you understand the electric devices you use in your daily life. In many other ways, knowledge of physical science can help you understand your natural and human-made environment.

- What have you learned by studying physical science that helps you understand the world around you?
- What else would you like to learn?

25.4 References

1. . http://commons.wikimedia.org/wiki/File:Hans_Christian_%C3%98rsted_daguerreotype.jpg . Public Domain
2. Christopher Auyeung. [CK-12 Foundation](#) . CC BY-NC 3.0
3. Hand by Wizard191, modified by Christopher Auyeung for CK-12 Foundation. [Hand from http://commons.wikimedia.org/wiki/File:Right-hand_grip_rule.svg](#) . CC BY-NC 3.0 (hand available under public domain)
4. Image copyright Peter Kim, 2013. <http://www.shutterstock.com> . Used under license from Shutterstock.com
5. Christopher Auyeung. [CK-12 Foundation](#) . CC BY-NC 3.0
6. Christopher Auyeung. [CK-12 Foundation](#) . CC BY-NC 3.0
7. Christopher Auyeung. [CK-12 Foundation](#) . CC BY-NC 3.0
8. Christopher Auyeung. [CK-12 Foundation](#) . CC BY-NC 3.0
9. Christopher Auyeung. [CK-12 Foundation](#) . CC BY-NC 3.0
10. Christopher Auyeung. [CK-12 Foundation](#) . CC BY-NC 3.0
11. Christopher Auyeung. [CK-12 Foundation](#) . CC BY-NC 3.0
12. User:Tomia/Wikimedia Commons. http://commons.wikimedia.org/wiki/File:Hydroelectric_dam.svg . CC BY 2.5
13. Christopher Auyeung. [CK-12 Foundation](#) . CC-BY-NC-SA 3.0
14. Christopher Auyeung. [CK-12 Foundation](#) . CC-BY-NC-SA 3.0
15. Christopher Auyeung. [CK-12 Foundation](#) . CC-BY-NC-SA 3.0

CHAPTER 26**Glossary****Chapter Outline**

26.1	A
26.2	B
26.3	C
26.4	D
26.5	E
26.6	F
26.7	G
26.8	H
26.9	I
26.10	J
26.11	K
26.12	L
26.13	M
26.14	N
26.15	O
26.16	P
26.17	Q
26.18	R
26.19	S
26.20	T
26.21	U
26.22	V
26.23	W
26.24	X
26.25	Y
26.26	Z

26.1 A

absorption

Interaction of light with matter in which the particles of matter absorb light energy so light neither reflects from nor passes through matter.

acceleration

Measure of the change in velocity of a moving object.

accuracy

Closeness of a measurement to the true value.

acid

Ionic compound that produces positive hydrogen ions (H^+) when dissolved in water.

acidity

Concentration of hydrogen ions in a solution.

activation energy

Energy needed to start a chemical reaction.

alkali metal

Metal in group 1 of the periodic table that has one valence electron and is highly reactive.

alkaline Earth metal

Metal in group 2 of the periodic table that has two valence electrons and is very reactive but less so than an alkali metal.

alkane

Saturated hydrocarbon that contains only single bonds between carbon atoms.

alkene

Unsaturated hydrocarbon that contains at least one double bond between carbon atoms.

alkyne

Unsaturated hydrocarbon that contains at least one triple bond between carbon atoms.

alloy

Mixture of a metal with one or more other elements.

alternating current (AC)

Electric current that keeps reversing the direction in which the current flows.

Amonton's law

Gas law stating that, if the volume of a gas is held constant, increasing the temperature of the gas increases its pressure.

Archimedes' law (or principle)

Law stating that the buoyant force acting on an object equals the weight of the fluid displaced by the object.

aromatic hydrocarbon

Unsaturated cyclic hydrocarbon that has a strong aroma and alternating single and double bonds between carbon atoms.

atom

Smallest particle of an element that still has the element's properties.

atomic mass unit (amu)

SI unit for the mass of an atom, where 1 amu = the mass of a proton (about 1.7×10^{-24} g).

atomic number

Number of protons in an atom.

26.2 B

base

Ionic compound that produces negative hydroxide ions (OH^-) when dissolved in water.

Bernoulli's law

Law stating that pressure in a moving fluid is less when the fluid is moving faster.

biochemical compound

Any carbon-based compound found in living things (carbohydrate, protein, lipid, or nucleic acid).

Boyle's law

Gas law stating that, if the temperature of a gas is held constant, increasing the volume of the gas decreases its pressure.

buoyancy

Ability of a fluid to exert an upward force on any object placed in the fluid.

bouyant force

Upward force exerted by a fluid on any object placed in it.

26.3 C

carbohydrate

Biochemical compound such as sugar, starch, or cellulose that contains oxygen in addition to carbon and hydrogen.

catalyst

Substance that increases the rate of a chemical reaction but is not changed or used up in the reaction.

cellular respiration

Process in which the cells of living things break down glucose with oxygen to produce carbon dioxide, water, and energy.

Charles's law

Gas law stating that, if the pressure of a gas is held constant, increasing its temperature increases its volume.

chemical bond

Force of attraction between atoms or ions that occurs when atoms share or transfer valence electrons.

chemical change

Change in matter that occurs when matter changes chemically into an entirely different substance with different chemical properties.

chemical energy

Energy that is stored in the bonds between atoms that make up compounds.

chemical equation

Symbolic representation of a chemical reaction.

chemical formula

Symbol of a chemical compound using element symbols and subscripts that shows the ratio of atoms in the compound.

chemical property

Property of matter that can be measured or observed only when matter changes to a different substance.

chemical reaction

Process in which some substances, called reactants, change chemically into different substances, called products.

chemistry

Study of the structure, properties, and interactions of matter, usually at a small scale such as atoms and molecules.

colloid

Homogeneous mixture in which the particles are large enough to reflect light but too small to settle or filter out of the mixture.

combustion engine

Chemical reaction in which a substance reacts quickly with oxygen, producing carbon dioxide, water, and energy; commonly called burning.

combustion reaction

Chemical reaction in which a substance reacts quickly with oxygen, producing carbon dioxide, water, and energy; commonly called burning.

compound

Unique substance that forms when two or more elements combine chemically.

compound machine

Machine that consists of more than one simple machine.

concave

Curving inward like the inside of a bowl.

concentration

Number of particles of a substance in a given volume.

condensation

Process in which a gas changes to a liquid.

conduction

Transfer of thermal energy between particles of matter that are touching.

conservation

Saving resources by using them more efficiently or not using them at all.

control

Variable in an experiment that is held constant so it will not influence the outcome.

convection

Transfer of thermal energy by particles moving through a fluid.

convection current

Flow of particles in a fluid that occurs because of differences in temperature and density.

convex

Curving outward like the outside of a bowl.

covalent bond

Force of attraction that holds together two atoms that share a pair of electrons.

covalent compound

Compound forms when atoms of nonmetals form molecules that are held together by covalent bonds.

crystal

Rigid, lattice-like framework of many atoms bonded together that is formed by some compounds such as table salt (NaCl).

26.4 D

decibel (dB)

Unit of intensity of sound.

decomposition reaction

Chemical reaction in which one reactant breaks down into two or more products.

density

Amount of mass in a given volume of matter; calculated as mass divided by volume.

deposition

Process in which a gas changes directly to a solid without going through the liquid state.

diffraction

Bending of a wave around an obstacle or through an opening in an obstacle.

direct current (DC)

Electric current that flows only in one direction.

distance

Length of the route between two points.

Doppler effect

Change in the frequency and pitch of sound that occurs when the source of the sound is moving relative to the listener.

26.5 E

efficiency

Measure of how well a machine reduces friction; calculated as the percent of input work that becomes output work.

elastic force

Counter force exerted by an elastic material when it is stretched or compressed.

elasticity

Ability of a material to return to its original shape after being stretched or compressed.

electrical energy

Energy of moving electrons.

electric charge

Physical property of particles or objects that causes them to attract or repel each other without touching; may be positive or negative.

electric circuit

Closed loop through which current can flow.

electric conductor

Material that has low resistance to the flow of electric current.

electric current

Continuous flow of electric charges due to a difference in electric potential energy, or voltage.

electric field

Space around a charged particle where the particle exerts electric force on other particles.

electric force

Force of attraction or repulsion between charged particles.

electric generator

Device that changes kinetic energy to electrical energy through electromagnetic induction.

electric insulator

Material that has high resistance to the flow of electric current.

electric motor

Device that uses an electromagnet to change electrical energy to kinetic energy.

electric transformer

Device that uses electromagnetic induction to change the voltage of electric current.

electromagnet

Magnet created by electric current flowing through a coil of wire that is wrapped around a bar of iron or other ferromagnetic material.

electromagnetic energy

Energy, such as sunlight, that travels across space or through matter as electric and magnetic waves.

electromagnetic induction

Process of generating electric current with a changing magnetic field.

electromagnetic radiation

Transfer of energy by electromagnetic waves across space or through matter.

electromagnetic spectrum

Full range of wavelengths of electromagnetic waves, from radio waves to gamma rays.

electromagnetic wave

Transverse wave consisting of vibrating electric and magnetic fields that can travel across space.

electromagnetism

Magnetism produced by electric current.

electron

Negatively charged atomic particle outside the nucleus of an atom.

electron cloud

Area surrounding the nucleus of an atom where electrons are likely to be.

electronics

Use of electric current to encode information.

element

Pure substance that cannot be separated into any other substances.

endothermic reaction

Chemical reaction that needs a constant input of energy to continue because it takes more energy to break bonds in the reactants than is released when new bonds form in the products.

energy

Ability to cause changes in matter.

energy conversion

Process in which energy changes from one type or form to another.

energy level

Areas located at fixed distances from the nucleus of an atom where electrons can orbit the nucleus.

engineer

Professional in technology.

enzyme

Biochemical catalyst that speeds up chemical reactions in living things.

equilibrium

Balance between opposing changes, such as the forward and reverse directions of a chemical reaction.

ethics

Rules for deciding between right and wrong.

evaporation

Process in which a liquid changes to a gas without boiling.

exothermic reaction

Chemical reaction that releases energy because it takes less energy to break bonds in the reactants than is released when new bonds form in the product.

experiment

Controlled scientific study of a limited number of variables.

26.6 F

Faraday's law

Law stating that a changing magnetic field produces an electric current in a conductor.

ferromagnetic material

Material that can be magnetized (iron, nickel, or cobalt).

field study

Investigation of a problem in a real-world setting.

flammability

Ability of matter to burn.

fluid

Substance that can flow and take the shape of its container; either liquid or gas.

force

Push or pull acting on an object.

fossil fuel

Mixture of hydrocarbons that formed over millions of years from the remains of dead organisms (petroleum, natural gas, or coal).

frame of reference

Something that is not moving with respect to an observer that can be used to detect motion.

freezing

Process in which a liquid changes to a solid.

friction

Force that opposes motion between two surfaces that are touching.

26.7 G

gamma ray

Type of wave in the electromagnetic spectrum that has the shortest wavelength and greatest amount of energy.

gas

State of matter that has neither a fixed volume nor a fixed shape.

gravity

As traditionally defined, force of attraction between two masses.

group

Column of the periodic table that contains elements with similar properties.

26.8 H

half-life

Length of time it takes for half of a given amount of a radioisotope to decay.

halogen

Nonmetal in group 17 of the periodic table that has seven valence electrons and is highly reactive.

heat

Transfer of thermal energy between objects that have different temperatures.

hertz (Hz)

SI unit of wave frequency, where 1 hertz equals 1 wave passing a fixed point per second.

hydrocarbon

Carbon-based compound that contains only carbon and hydrogen.

hydrogen bond

Weak bond that forms between a slightly positive hydrogen atom in one molecule and a slightly negative atom in another molecule.

hypothesis

Potential answer to a question that can be tested by gathering information.

26.9 |

image

Copy of an object that is formed by reflected or refracted light.

incandescence

Production of visible light by an object that is so hot it glows.

inclined plane

Simple machine consisting of a sloping surface that connects lower and higher elevations.

induction

Drawing general conclusions from many individual observations.

inertia

Tendency of an object to resist a change in its motion.

infrared light

Part of the electromagnetic spectrum in which waves have a wavelength between those of radio waves and visible light.

infrasound

Sound with a frequency below the range of human hearing (less than 20 hertz).

insoluble

Unable to dissolve in a given solvent.

intensity

Measure of the amount of energy in sound waves, which is determined by the amplitude of the waves and how far they have traveled and spread out from the source of the sound.

ion

Positively or negatively charged form of an atom that has lost or gained electron(s).

ionic bond

Force of attraction that holds together positive and negative ions that forms when atoms of a metal give up valence electrons to atoms of a nonmetal.

ionic compound

Compound that forms when oppositely charged metal and nonmetal ions are held together in a crystal by ionic bonds.

isomer

Compound that has the same chemical formula as another compound but has molecules with a different shape and may have somewhat different properties.

isotope

Atom of an element that differs in number of neutrons from other atoms of the element.

26.10 J

joule (J)

SI unit for work, equal to the amount of work that is done when 1 newton of force moves an object over a distance of 1 meter.

26.11 K

Kelvin scale

SI scale for measuring temperature in which the freezing point of water is 273 K and the boiling point of water is 373 K.

kinetic energy

Energy of moving matter.

kinetic theory of matter

Theory that all matter consists of constantly moving particles.

26.12 L

laser

Device that produces a very focused beam of light of just one wavelength and color.

law of conservation of charge

Law stating that charges are not destroyed when they are transferred between two materials or within a material, so the total charge remains the same.

law of conservation of energy

Law stating that energy cannot be created or destroyed in chemical reactions.

law of conservation of mass

Law stating that matter cannot be created or destroyed in chemical reactions.

law of conservation of momentum

Law stating that, when an action and reaction occur, the combined momentum of the objects remains the same.

law of reflection

Law stating that the angle at which reflected rays of light bounce off a surface is equal to the angle at which the incident rays strike the surface.

law of universal gravitation

Law stating that gravity is a force of attraction between all objects in the universe and that the strength of gravity is greater when masses of objects are greater or distances between objects are shorter.

lens

Transparent object with one or two curved surfaces that forms images by refracting light.

lever

Simple machine consisting of a bar that rotates around a fixed point called the fulcrum.

lipid

Biochemical compound such as fat or oil that contains oxygen in addition to carbon and hydrogen and is made up of long carbon chains called fatty acids.

liquid

State of matter that has a fixed volume but not a fixed shape.

longitudinal wave

Wave in which particles of the medium vibrate in the same direction that the wave travels.

loudness

How a listener perceives the intensity of sound.

luminescence

Production of visible light that does not involve high temperatures but instead occurs through chemical reactions or other means.

26.13 M

machine

Any device that makes work easier by changing a force.

magnet

Object that attracts ferromagnetic materials such as iron.

magnetic domain

Area of a ferromagnetic material where the north and south poles of atoms are all lined up in the same direction.

magnetic field

Area around a magnet where it exerts magnetic force.

magnetic force

Force of attraction or repulsion exerted by a magnet.

magnetic pole

North or south end of a magnet where the magnet exerts the most force.

magnetism

Ability of a material to respond to and exert magnetic force.

magnetosphere

Region surrounding Earth that is affected by Earth's magnetic force; name for Earth's magnetic field.

manipulated variable

Factor that is changed, or manipulated, by a researcher in a scientific experiment; also called independent variable.

mass

Amount of matter in a substance or object.

mass number

Number of protons plus neutrons in an atom; about equal to the atom's mass in atomic mass units (amu).

matter

Anything that has mass and volume.

mean

Average value of a set of measurements that is calculated by summing the individual measurements and then dividing the total by the number of measurements.

mechanical advantage

Number of times a machine multiplies the input force; calculated as the output force divided by the input force.

mechanical energy

Energy of an object that is moving or has the potential to move; calculated as the sum of an object's kinetic and potential energy.

mechanical wave

Disturbance in matter that transfers energy from one place to another.

melting

Process in which a solid changes to a liquid.

metal

Class of elements that are good conductors of electricity.

metallic bond

Force of attraction between a positive metal ion and valence electrons it shares with other ions of the metal.

metalloid

Class of elements that have some properties of metals and some properties of nonmetals.

microwave

Wave in the electromagnetic spectrum that falls at the upper range of radio waves.

mixture

Combination of two or more substances in any proportions.

model

Representation of an object, system, or process.

molecule

Smallest particle of a compound that still has the compound's properties.

momentum

Property of a moving object that makes it hard to stop; equal to the object's mass times its velocity.

monomer

Small molecule that forms covalent bonds with other small molecules to produce a large molecule called a polymer.

motion

Change in position.

26.14 N

natural resource

Anything people can use that comes from nature.

net force

Overall force acting on an object that takes into account all of the individual forces acting on the object.

neutralization reaction

Reaction of an acid and a base that produces water and a salt, both of which are neutral in acidity.

neutron

Electrically neutral atomic particle inside the nucleus of an atom.

newton (N)

SI unit of force, equal to the amount of force that causes a mass of 1 kilogram to accelerate at 1 m/s^2 ($\text{kg}\cdot\text{m/s}^2$).

Newton's first law of motion

Law stating that an object's motion will not change unless an unbalanced force acts on the object.

Newton's second law of motion

Law stating that the acceleration of an object equals the net force acting on the object divided by the object's mass.

Newton's third law of motion

Law stating that every action has an equal and opposite reaction.

noble gas

Nonmetal in group 18 of the periodic table that has eight valence electrons (or two in the case of helium) and is unreactive.

nonmetal

Class of elements that do not conduct electricity.

nonpolar

Not having oppositely charged ends, as in nonpolar covalent bond or nonpolar covalent compound.

nonrenewable resource

Natural resource that is limited in supply and cannot be replaced except over millions of years.

nuclear energy

Energy released in nuclear reactions.

nuclear fission

Splitting of the nucleus of an atom into two smaller nuclei.

nuclear fusion

Fusing of two or more small nuclei to form a single, larger nucleus.

nucleic acid

Biochemical compound (either DNA or RNA) that contains oxygen, nitrogen, and phosphorus in addition to carbon and hydrogen and is made up of one or two long chains of smaller molecules called nucleotides.

nucleus

Tiny region in the center of an atom that contains protons and neutrons and makes up almost all of an atom's mass.

26.15 O

observation

Any information that is gathered with the senses.

Ohm's law

Law stating that current increases as voltage increases or resistance decreases.

opaque

Referring to matter that does not allow visible light to pass through it because it reflects or absorbs all of the light.

optics

Study of visible light and the ways it can be used to extend human vision and do other tasks.

orbit

Path of one object around another, such as the path of the moon around Earth or of Earth around the sun.

orbital

Region of an energy level in the electron cloud around an atom where electrons are most likely to be.

26.16 P

parallel circuit

Electric circuit that has two (or more) loops through which current can flow.

pascal (Pa)

SI unit for pressure, equal to 1 newton per square meter (N/m²).

Pascal's law

Law stating that a change in pressure at any point in an enclosed fluid is transmitted equally throughout the fluid.

period

Row of the periodic table that contains elements ranging from metals on the left to metalloids and then nonmetals on the right.

periodic table

Table of elements arranged by increasing atomic number (modern periodic table) or by increasing atomic mass (Mendeleev's periodic table).

pH

Measure of the acidity, or hydrogen ion (H⁺) concentration, of a substance.

photon

Tiny "packet" of electromagnetic radiation that is released when an electron returns to a lower energy level.

photosynthesis

Process in which plants and certain other organisms use light energy to synthesize glucose from carbon dioxide and water and release oxygen.

physical change

Change in one or more of matter's physical properties.

physical property

Property of matter that can be measured or observed without matter changing to a different substance.

physical science

Study of matter and energy.

physics

Study of energy and how it interacts with matter.

pigment

Substance that colors materials by reflecting light of certain wavelengths and absorbing light of all other wavelengths.

pitch

How high or low a sound seems to a listener.

plasma

State of matter lacking a fixed volume and fixed shape that contains ions so it can conduct electricity and respond to magnetism.

polar

Having oppositely charged ends, as in polar covalent bond or polar covalent compound.

polymer

Large molecule that consists of many smaller molecules, called monomers, joined together by covalent bonds.

potential energy

Stored energy an object has because of its position or shape.

power

Measure of the amount of work that can be done in a given amount of time.

precision

Exactness of a measurement.

pressure

Amount of force pushing against a given area.

primary color

One of three colors of light (red, green, or blue) that can be combined to produce all other colors of light.

product

Substance that is produced in a chemical reaction.

projectile motion

Motion of an object that has initial horizontal velocity but is also pulled down toward Earth by gravity.

protein

Biochemical compound that contains oxygen, nitrogen, and sulfur in addition to carbon and hydrogen and is made up of one or more chains of smaller molecules called amino acids.

proton

Positively charged atomic particle inside the nucleus of an atom.

pulley

Simple machine that consist of a rope and grooved wheel.

26.17 Q

quark

Particle of matter that makes up protons and neutrons.

26.18 R

radar

radio detection and ranging; use of reflected radio waves to track the position of objects

radiation

general term for the charged particles and energy emitted by the nucleus of a radioisotope, or for energy emitted when charged particles accelerate

radioactive dating

method of determining the age of fossils or rocks that is based on the rate of decay of radioisotopes

radioactive decay

process in which unstable nuclei of radioisotopes become stable by emitting charge particles and energy and becoming other elements

radioactivity

ability of an atom to emit charged particles and energy from the nucleus

radioisotope

radioactive isotope, or isotope that emits radiation from its nucleus

radio wave

any wave in the electromagnetic spectrum that has a wavelength longer than infrared light

range

total spread of values in a set of measurements that is calculated by subtracting the smallest value from the largest value

reactant

substance that starts a chemical reaction

reaction rate

speed at which a chemical reaction occurs

reactivity

ability of matter to combine chemically with other substances

reflection

bouncing back of waves from a barrier they cannot pass through

refraction

bending of waves as they enter a new medium at an angle and change speed

refrigerant

substance with a low boiling point that is used to transfer thermal energy in a cooling system such as a refrigerator

renewable resource

natural resource that can be replaced in a relatively short period of time or is virtually limitless in supply

replacement reaction

chemical reaction in which ions switch places in one compound (single replacement) or in two compounds (double replacement)

replication

getting the same results when an investigation is repeated

resistance

opposition to the flow of electric charges that occurs when electric current travels through matter

resonance

vibration of an object in response to sound waves of a certain frequency

responding variable

factor in an experiment that is expected to change, or respond, when the manipulated variable changes; also

called the dependent variable

26.19 S

salt

Ionic compound formed when an acid and base react.

saturated hydrocarbon

Hydrocarbon that contains only single bonds between carbon atoms.

saturated solution

Solution that contains as much solute as can dissolve at a given temperature.

scattering

Process in which transmitted light is spread out in all directions by particles of matter.

science

Way of learning about the natural world that is based on evidence and logic.

scientific law

Statement describing what always happens under certain conditions in nature.

scientific notation

Way of writing very large or very small numbers that uses exponents in the format $a \times 10^b$.

scientific theory

Broad explanation that is widely accepted because it is supported by a great deal of evidence.

screw

Simple machine that consists of an inclined plane wrapped around a cylinder or cone.

semiconductor

Solid crystal—usually consisting mainly of silicon—that can conduct current better than an electric insulator but not as well as an electric conductor; found in electronic components.

series circuit

Electric circuit that has only one loop through which current can flow.

SI

International System of Units, which is used by most scientists.

significant figures

Correct number of digits in an answer that is based on the least precise measurement used in the calculation.

solenoid

Coil of wire with electric current flowing through it, giving it a magnetic field like a bar magnet.

solid

State of matter that has a fixed volume and fixed shape.

solubility

Amount of solute that can dissolve in a given amount of solvent at a given temperature.

soluble

Able to dissolve in a given solvent.

solute

Substance that dissolves in a solvent to form a solution.

solution

Homogeneous mixture in which particles are too small to reflect light and too small to settle or be filtered out of the mixture.

solvent

Substance that dissolves a solute to form a solution.

sonar

Sound navigation and ranging; use of reflected ultrasound waves to locate objects under water.

sound

Transfer of energy from a vibrating object in longitudinal waves that travel through matter.

sound energy

Energy that travels in waves through matter from a vibrating object.

specific heat

Amount of energy (in joules) needed to raise the temperature of 1 kilogram of a substance by 1 °C.

speed

How quickly or slowly something moves; calculated as distance divided by time.

speed of light

Speed at which all electromagnetic waves travel through space, which is 3.0×10^8 m/s.

standing wave

Wave appearing to stand still that forms when a wave and its reflected wave interfere.

states of matter

Different forms (solid, liquid, gas, and plasma) in which matter can exist without the chemical makeup of matter changing.

static discharge

Sudden flow of electrons from an object that has a buildup of charges.

static electricity

Buildup of charges on an object that occurs through induction.

sublimation

Process in which a solid changes directly to a gas without going through the liquid state.

surface wave

Combined transverse longitudinal wave that travels along the surface of a medium.

suspension

Heterogeneous mixture in which particles are large enough to reflect light and to settle or be filtered out of the mixture.

synthesis reaction

Chemical reaction in which two or more reactants combine to form a single product.

26.20 T

technological design

Development of new technology.

technology

Application of knowledge to real-world problems.

temperature

Average kinetic energy of particles of matter.

thermal conductor

Material that is a good conductor of thermal energy.

thermal energy

Total kinetic energy of all the atoms that make up an object.

thermal insulator

Material that is a poor conductor of thermal energy.

transition metal

Metal in groups 3 to 12 of the periodic table that is hard and shiny and less reactive than metals in groups 1 and 2.

translucent

Metal in groups 3 to 12 of the periodic table that is hard and shiny and less reactive than metals in groups 1 and 2.

transmission

Process in which light passes through matter.

transparent

Referring to matter that allows all visible light to pass through.

transverse wave

Wave in which particles of the medium vibrate at right angles to the direction that the wave travels.

26.21 U

ultrasound

Sound with a frequency above the range of human hearing (greater than 20,000 hertz).

ultraviolet light

Electromagnetic radiation with a wavelength falling between the wavelengths of visible light and X rays.

unsaturated hydrocarbon

Hydrocarbon that contains at least one double or triple bond between carbon atoms.

unsaturated solution

Solution that contains less solute than can dissolve at a given temperature.

26.22 V

valence electron

Electron in the outer energy level of an atom that is potentially involved in chemical reactions.

vaporization

Process in which a liquid boils and changes to a gas.

vector

Quantity such as velocity that includes both size and direction; represented by an arrow.

velocity

Measure of both speed and direction of motion.

visible light

Range of wavelengths of electromagnetic waves that the human eye can detect.

voltage

Difference in electric potential energy between two positions; also called potential difference.

volume

Amount of space that matter takes up.

26.23 W**watt (W)**

SI unit for work, equal to 1 joule of work per second.

wave amplitude

Maximum distance the particles of a medium move from their resting positions when a wave passes through.

wave frequency

Number of waves that pass a fixed point in a given amount of time.

wave interference

Interaction of waves with other waves.

wavelength

Distance between two corresponding points of adjacent waves, such as the distance between two adjacent crests of a transverse wave.

wave speed

How far a wave travels in a given amount of time; calculated as wavelength multiplied by wave frequency.

wedge

Simple machine that consists of two inclined planes.

weight

Measure of the force of gravity pulling on an object.

wheel and axle

Simple machine that consists of two connected rings or cylinders, one inside the other, which turn in the same direction around a center point.

work

Use of force to move an object; calculated as force multiplied by distance.

26.24 X

X ray

Wave in the electromagnetic spectrum with a wavelength between the wavelengths of ultraviolet light and gamma rays.

26.25 Y

26.26 Z